

**FM 3-04.301(1-301)**

**AEROMEDICAL TRAINING  
FOR FLIGHT PERSONNEL**

**DISTRIBUTION RESTRICTION: Approved for public release; distribution unlimited.**

**HEADQUARTERS, DEPARTMENT OF THE ARMY**

# Aeromedical Training for Flight Personnel

## Contents

	Page
	<b>PREFACE</b> ..... vi
<b>Chapter 1</b>	<b>TRAINING PROGRAMS</b> ..... 1-1
	Training Requirements..... 1-1
	Aeromedical Training in Specific Courses ..... 1-1
	Hypobaric Refresher Training ..... 1-1
	Special Training by Other Services..... 1-2
	Unit Training..... 1-2
	Responsibilities ..... 1-3
	Revalidation and Waiver ..... 1-3
	Training Record ..... 1-4
<b>Chapter 2</b>	<b>ALTITUDE PHYSIOLOGY</b> ..... 2-1
	<b>Section I – Atmosphere</b> ..... 2-1
	Physical Characteristics of the Atmosphere ..... 2-1
	Structure of the Atmosphere ..... 2-1
	Composition of the Atmosphere..... 2-3
	Atmospheric Pressure..... 2-4
	Physiological Zones of the Atmosphere..... 2-6
	<b>Section II – Circulatory System</b> ..... 2-7
	Structure and Function of the Circulatory System..... 2-7
	Components and Functions of Blood..... 2-8

DISTRIBUTION RESTRICTION: **Approved for public release, distribution unlimited.**

---

**\*This publication supersedes FM 1-301, 29 May 1987**

	<b>Section III – Respiratory System</b> .....	2-10
	The Processes of Breathing and Respiration .....	2-10
	Functions of Respiration .....	2-10
	Phases of External Respiration.....	2-11
	Components of the Respiratory System .....	2-13
	<b>Section IV – Hypoxia</b> .....	2-16
	Characteristics of Hypoxia .....	2-16
	Types of Hypoxia .....	2-16
	Signs, Symptoms, and Susceptibility to Hypoxia .....	2-18
	Effects of Hypoxia .....	2-20
	Stages of Hypoxic Hypoxia .....	2-21
	Prevention of Hypoxic Hypoxia .....	2-23
	Treatment of Hypoxia.....	2-24
	<b>Section V – Hyperventilation</b> .....	2-24
	Characteristics of Hyperventilation.....	2-24
	Causes of Hyperventilation .....	2-24
	Signs and Symptoms of Hyperventilation .....	2-25
	Treatment of Hyperventilation .....	2-25
	<b>Section VI – Pressure-Change Effects</b> .....	2-26
	Dysbarism .....	2-26
	Trapped-Gas Disorders .....	2-26
	Evolved-Gas Disorders .....	2-32
<b>Chapter 3</b>	<b>STRESS AND FATIGUE IN FLYING OPERATIONS</b> .....	3-1
	Stress Defined .....	3-1
	Identifying Stressors.....	3-1
	The Stress Response .....	3-10
	Stress and Performance .....	3-11
	Stress Management.....	3-12
	Fatigue .....	3-13
	Effects of Fatigue on Performance .....	3-14
	Diurnal (Circadian) Rhythms and Fatigue .....	3-15
	The Sleep Cycle.....	3-16
	Sleep Requirements .....	3-16
	Prevention of Fatigue .....	3-17
	Treatment of Fatigue.....	3-18
<b>Chapter 4</b>	<b>GRAVITATIONAL FORCES</b> .....	4-0
	Terms of Acceleration .....	4-0
	Types of Acceleration.....	4-0

	Gravitational Forces .....	4-2
	Factors Affecting Accelerative Forces .....	4-3
	Physiological Effects of Low-Magnitude Acceleration.....	4-4
	Physiological Effects of +G <sub>z</sub> Acceleration .....	4-5
	Physiological Effects of –G <sub>z</sub> Acceleration .....	4-7
	Physiological Effects of +/-G <sub>z</sub> Acceleration .....	4-8
	Physiological Effects of +/-G <sub>y</sub> Acceleration.....	4-9
	Physiological Effects of High-Magnitude Acceleration and Deceleration.....	4-9
	Preventive Measures .....	4-14
<b>Chapter 5</b>	<b>TOXIC HAZARDS IN AVIATION .....</b>	<b>5-0</b>
	<b>Section I – Aviation Toxicology Principles.....</b>	<b>5-0</b>
	Environment.....	5-0
	Acute Toxicity.....	5-0
	Chronic Toxicity.....	5-1
	Time and Dose Relationship.....	5-1
	Physiochemical Factors .....	5-1
	Entry Points.....	5-1
	Preexisting Conditions .....	5-1
	Individual Variability.....	5-2
	Allowable Degree of Bodily Impairment .....	5-2
	Body Detoxification .....	5-2
	<b>Section II – Aircraft Atmosphere Contamination .....</b>	<b>5-3</b>
	Contamination Overview .....	5-3
	Exhaust Gases.....	5-3
	Carbon Monoxide.....	5-3
	Aviation Gasoline .....	5-5
	Tetraethyl Lead in Aviation Gasoline .....	5-6
	Jet Propulsion Fuels.....	5-6
	Hydraulic Fluid Vapors .....	5-7
	Coolant Fluid Vapors.....	5-7
	Engine Lubricants .....	5-7
	Fire-Extinguishing Agents .....	5-7
	Fluorocarbon Plastics .....	5-9
	Oxygen Contamination.....	5-10
	Protective Measures .....	5-10
<b>Chapter 6</b>	<b>EFFECTS OF TEMPERATURE EXTREMES ON THE HUMAN BODY.....</b>	<b>6-1</b>
	<b>Section I – Heat in the Aviation Environment .....</b>	<b>6-1</b>
	Heat Effects .....	6-1

	Heat Transfer .....	6-2
	Performance Impairment .....	6-4
	Heat-Stress Prevention .....	6-4
	In-Flight Heat-Stress Reduction .....	6-5
	<b>Section II – Cold</b> .....	6-5
	Cold Effects in the Aviation Environment .....	6-5
	Types and Treatment of Cold Injury .....	6-6
	Cold-Injury Prevention .....	6-6
<b>Chapter 7</b>	<b>NOISE AND VIBRATION IN ARMY AVIATION</b> .....	7-0
	Noise Characteristics and Effects .....	7-0
	Sound and Vibrational Measurement .....	7-1
	Noise and Hearing Levels .....	7-2
	Vibrational Effects .....	7-4
	Hearing Loss .....	7-4
	Hearing Protection and Reduction of Vibrational Threat .....	7-5
	Preventive Measures .....	7-10
<b>Chapter 8</b>	<b>PRINCIPLES AND PROBLEMS OF VISION</b> .....	8-0
	Visual Deficiencies .....	8-0
	Anatomy and Physiology of the Eye .....	8-3
	Types of Vision .....	8-6
	Factors Affecting Object Visibility .....	8-10
	Dark Adaptation .....	8-10
	Night-Vision Protection .....	8-11
	Night-Vision Techniques .....	8-13
	Distance Estimation and Depth Perception .....	8-16
	Visual Illusions .....	8-21
	Meteorological Conditions and Night Vision .....	8-21
	Self-Imposed Stress and Vision .....	8-22
	Nerve Agents and Night Vision .....	8-25
	Flight Hazards .....	8-25
	Protective Measures .....	8-27
	Principles of Proper Vision .....	8-28
<b>Chapter 9</b>	<b>SPATIAL DISORIENTATION</b> .....	9-1
	Common Terms of Spatial Disorientation .....	9-1
	Types of Spatial Disorientation .....	9-1
	Equilibrium Maintenance .....	9-2
	Visual Illusions .....	9-9
	Vestibular Illusions .....	9-14

	Proprioceptive Illusions .....	9-18
	Prevention of Spatial Disorientation .....	9-18
	Treatment of Spatial Disorientation.....	9-19
<b>Chapter 10</b>	<b>OXYGEN EQUIPMENT AND CABIN PRESSURIZATION .....</b>	<b>10-0</b>
	Oxygen Systems .....	10-0
	Storage Systems.....	10-1
	Oxygen Regulators .....	10-1
	Oxygen Masks .....	10-3
	Oxygen-Equipment Checklist.....	10-4
	Cabin Pressurization .....	10-4
<b>Appendix</b>	<b>HYPOBARIC CHAMBER FLIGHT PROFILES .....</b>	<b>A-0</b>
	<b>GLOSSARY .....</b>	<b>Glossary-0</b>
	<b>BIBLIOGRAPHY.....</b>	<b>Bibliography-0</b>
	<b>INDEX .....</b>	<b>Index-1</b>

## Preface

Lessons learned from previous military conflicts and recent contingency operations have caused changes in Army aviation doctrine and the development of more sophisticated aircraft and weapons systems. Army aircrew members must be capable of operating these systems around the clock, in austere environments, and under adverse conditions. They must be capable of employing these systems and avoid enemy air defense and air-to-air weapons systems. The hazards of stress and fatigue imposed by operating more sophisticated systems in combat operations and CONOPS will eventually take a toll in aircrew performance and could jeopardize mission accomplishment. Aircrew members must be trained to recognize and understand these hazards. Training can prepare aircrew members and prevent stress and fatigue from reducing their mission effectiveness and increase their chances of survival.

This manual gives aircrew members an understanding of their physiological responses to the aviation environment; it also describes the effects of the flight environment on individual mission accomplishment. In addition, it outlines the essential aeromedical training requirements (in Chapter 1) that assist the commander and flight surgeon in conducting aeromedical education for Army aircrew members. The subject areas addressed in the training are by no means all inclusive but are presented to assist aircrew members in increasing their performance and efficiency through knowing human limitations. This manual is intended for use by all Army aircrew members in meeting requirements set forth in AR 95-1, TC 1-210, and other appropriate aircrew training manuals.

The proponent of this publication is Headquarters, TRADOC. Send comments and recommendations on DA Form 2028 (Recommended Changes to Publications and Blank Forms) to Dean, US Army School of Aviation Medicine, ATTN: MCCS-HA, Fort Rucker, Alabama 36362-5377.

The provisions of this publication are the subject of the following international agreement: STANAG 3114 (Edition Six).

The use of trade names in this manual is for clarity only and does not constitute endorsement by the Department of Defense.

This publication has been reviewed for operations security considerations.

Unless this publication states otherwise, masculine nouns or pronouns do not refer exclusively to men.

## Chapter 1

# Training Programs

Aircrews must be trained and ready in peacetime to perform their missions in combat or other contingency operations. Therefore, leaders at all levels must understand, sustain, and enforce high standards of combat readiness. Tough, realistic training should be designed to challenge and develop soldiers, leaders, and units. This chapter outlines the essential aeromedical training requirements needed for all aircrew members.

### **TRAINING REQUIREMENTS**

1-1. All U.S. Army flight students receive aeromedical training during initial flight training and during designated courses given at the United States Army Aviation Center, Fort Rucker, Alabama. Aeromedical training is also provided for specific aviators during refresher training courses. In addition, unit commanders are responsible for aeromedical training at the unit level.

### **AEROMEDICAL TRAINING IN SPECIFIC COURSES**

1-2. Initial aeromedical training is conducted for all U.S. Army students in the Initial Entry Rotary Wing Course. Their initial physiological training is performed according to the provisions of STANAG 3114 and TRADOC programs of instruction at USAAVNC. Aeromedical training is conducted for aviators receiving transition or advanced training at USAAVNC in the following courses:

- Fixed-Wing Multiengine Qualification Course.
- Fixed-Wing Multiengine Instructor Pilot Course.
- Aviation Safety Officer Course.

### **HYPOBARIC REFRESHER TRAINING**

1-3. Crew members and Department of the Army civilians who fly in pressurized aircraft or in aircraft that routinely exceed 10,000 feet MSL receive hypobaric training. Refresher training is conducted once every three years. The aviators trained are those who fly in pressurized aircraft or in aircraft that routinely exceed 10,000 feet MSL.

1-4. Refresher training consists of classroom instruction to review the essential materials presented in the initial training. After completing classroom instruction, aviators participate in a hypobaric (low-pressure/high-altitude) chamber exercise using the appropriate profile for the aircraft flown (see the appendix).

## **SPECIAL TRAINING BY OTHER SERVICES**

1-5. U.S. Air Force or U.S. Navy physiological training units can be used if aviators cannot attend aeromedical training, including hypobaric (low-pressure/high-altitude) chamber qualification, at the U.S. Army School of Aviation Medicine at Fort Rucker. Initial and refresher training conducted by the other services normally meets U.S. Army requirements or can usually be modified to meet the needs of U.S. Army units. The physiological training conducted by other services meets U.S. Army requirements for renewing aeromedical training currency for a three-year period.

## **UNIT TRAINING**

1-6. The unit commander must develop an aeromedical training program that meets the unit's specific needs as part of the Aircrew Training Program governed by TC 1-210. This training is crucial because most Army aircrew members are not required to attend the established refresher training courses previously described.

1-7. The unit's mission and its wide range of operations are the important factors for commanders to consider in developing an aeromedical training program. The program includes the various aeromedical factors that affect crew members' performance in different environments, during flight maneuvers, and while wearing protective gear. The unit aeromedical training program will contain, as a minimum, the continuous training and special training described below.

1-8. Because of the medical and technical nature of the aeromedical training program, commanders will involve their supporting flight surgeon in developing the program. The flight surgeon will provide input into all aspects of unit aviation plans, operations, and training. Commanders can obtain further assistance in developing a unit aeromedical training program from the Dean, US Army School of Aviation Medicine, ATTN: MCCS-HA, Fort Rucker, Alabama 36362-5377.

## **CONTINUOUS TRAINING**

1-9. The requirement for continuous training applies to all U.S. Army aircrew members in operational flying positions. The POI must be conducted in intervals of three years or less. When personnel turnover is high, a two-year cycle is recommended. The following subjects are the minimum training necessary for the unit to obtain adequate safety and efficiency in an aviation environment:

- Altitude physiology.
- Spatial disorientation.
- Noise in Army aviation.
- Night vision.
- Illusions of flight.
- Stress and fatigue.
- Protective equipment.

- Health maintenance.
- Toxic hazards in aviation.

## **SPECIAL TRAINING**

1-10. The unit commander must evaluate the missions of the unit to determine its special aeromedical training requirements. This analysis should include the following:

- Combat mission.
- Installation support missions.
- Contingency missions.
- Past requirements.
- Geographic and climatic considerations.
- Programmed training activities.

1-11. The supporting flight surgeon will help identify the aeromedical factors present during the various flight conditions and their effect on aircrews' performance. The flight surgeon and the unit commander will then develop a POI that meets the specific needs of the unit.

1-12. Commanders will include all crew members in the unit aeromedical training program. Without proper training and experience, the crew member may not understand individual limitations and the risks involved in the aviation environment.

## **RESPONSIBILITIES**

### **THE U.S. ARMY SCHOOL OF AVIATION MEDICINE**

1-13. USASAM, at Fort Rucker, Alabama, is responsible for planning supervising, and conducting all formal aeromedical U.S. Army aviation training programs. USASAM also advises and assists unit commanders and flight surgeons in developing local unit aeromedical training programs.

### **THE UNIT COMMANDER**

1-14. The unit commander, assisted by the flight surgeon, will develop a local unit aeromedical training program. The program should be designed to meet the unit's mission requirements.

### **THE FLIGHT SURGEON**

1-15. The flight surgeon provides medical support. He also assists the unit commander in developing, presenting, and monitoring a unit aeromedical training program.

## **REVALIDATION AND WAIVER**

### **REVALIDATION**

1-16. Aircrew members are required to stay current in aeromedical training and hypobaric (low-pressure/high-altitude) chamber training, according to

AR 95-1, TC 1-210, and the appropriate ATM. To meet ATP requirements if currency lapses, an aircrew member must undergo refresher training and reevaluation.

## **WAIVER**

1-17. AR 95-1 contains waiver procedures.

## **TRAINING RECORD**

1-18. When an aircrew member completes the prescribed qualification, the training record will be established, as explained below.

## **INITIAL AEROMEDICAL TRAINING**

1-19. After the aircrew member has completed training, the following entry is to be made in the REMARKS section of the DA Form 759 (Individual Flight Record and Flight Certificate—Army): “Individual has completed initial physiological training prescribed in FM 1-301 including hypobaric (low-pressure/high-altitude) chamber qualification on (date).”

## **REFRESHER TRAINING**

1-20. The REMARKS section of DA Form 759 should contain the following entry: “Individual has completed refresher physiological training including hypobaric (low-pressure/high-altitude) chamber qualification on (date).”

## **SPECIAL TRAINING BY OTHER SERVICES**

1-21. When aeromedical training is conducted by the U.S. Air Force or U.S. Navy, the forms listed may be used to document the training qualification if DA Form 759 is not available. The appropriate entry will be made in the REMARKS section of the applicable form when the aircrew member completes training. The forms that other services may use are—

- AF1274 (Physiological Training).
- AF702 (Individual Physiological Training Record).
- NAVMED 6150/2 (Special Duty Medical Abstract).
- NAVMED 6410/7 (Completion of Physiological Training).

1-22. Appropriate entries will be made on an SF 600 (Health Record—Chronological Record of Medical Care), which is filed in the DA Form 3444-series (Terminal Digit File for Treatment Record). This information will document any medical difficulties that the individual may have encountered during altitude-chamber qualification.

## Chapter 2

# Altitude Physiology

Human beings are not physiologically equipped for high altitudes. To cope, we must rely on preventive measures and, in some cases, life-support equipment. Although Army aviation primarily involves rotary-wing aircraft flying at relatively low altitudes, aircrews may still encounter altitude-associated problems. These may cause hypoxia, hyperventilation, and trapped-gas and evolved-gas disorders. By understanding the characteristics of the atmosphere, aircrews are better prepared for the physiological changes that occur with increasing altitudes.

### SECTION I – ATMOSPHERE

#### PHYSICAL CHARACTERISTICS OF THE ATMOSPHERE

2-1. The atmosphere is like an ocean of air that surrounds the surface of the Earth. It is a mixture of water and gases. The atmosphere extends from the surface of the Earth to about 1,200 miles in space. Gravity holds the atmosphere in place. The atmosphere exhibits few physical characteristics; however, it shields the inhabitants of the Earth from ultraviolet radiation and other hazards in space. Without the atmosphere, the Earth would be as barren as the moon.

#### STRUCTURE OF THE ATMOSPHERE

2-2. The atmosphere consists of several concentric layers, each displaying its own unique characteristics. Each layer is known as a sphere. Thermal variances within the atmosphere help define these spheres, offering aviation personnel an insight into atmospheric conditions within each area. Between each of the spheres is an imaginary boundary, known as a pause.

#### THE TROPOSPHERE

2-3. The troposphere extends from sea level to about 26,405 feet over the poles to nearly 52,810 feet above the equator. It is distinguished by a relatively uniform decrease in temperature and the presence of water vapor, along with extensive weather phenomena.

2-4. Temperature changes in the troposphere can be accurately predicted using a mean-temperature lapse rate of  $-1.98$  degrees Celsius per 1,000 feet. Temperatures continue to decrease until the rising air mass achieves an altitude where temperature is in equilibrium with the surrounding atmosphere. Table 2-1 illustrates the mean lapse rate and the pressure decrease associated with ascending altitude.

**Table 2-1. Standard Pressure and Temperature Values at 40 Degrees Latitude for Specific Altitudes**

<b>Altitude (feet)</b>	<b>Pressure (in/Hg)</b>	<b>Pressure (mm/Hg)</b>	<b>Pressure (psi)</b>	<b>Temperature (°C)</b>	<b>Temperature (°F)</b>
Sea Level	29.92	760.0	14.69	15.0	59.0
10,000	20.58	522.6	10.11	-4.8	23.3
18,000	14.95	379.4	7.34	-20.7	-5.3
20,000	13.76	349.1	6.75	-24.6	-12.3
25,000	10.51	281.8	5.45	-34.5	-30.1
30,000	8.90	225.6	4.36	-44.4	-48.0
34,000	7.40	187.4	3.62	-52.4	-62.3
35,332	6.80	175.9	3.41	-55.0	-67.0
40,000	5.56	140.7	2.72	-55.0	-67.0
43,000	4.43	119.0	2.30	-55.0	-67.0
50,000	3.44	87.3	1.69	-55.0	-67.0

**THE STRATOSPHERE**

2-5. The stratosphere extends from the tropopause to about 158,430 feet (about 30 miles). The stratosphere can be subdivided based on thermal characteristics found in different regions. Although these regions differ thermally, the water-vapor content of both regions is virtually nonexistent.

2-6. The first subdivision of the stratosphere is termed the isothermal layer. In the isothermal layer, temperature is constant at -55 degrees Celsius (-67 degrees Fahrenheit). Turbulence, traditionally associated with the stratosphere, is attributed to the presence of fast-moving jet streams, both here and in the upper regions of the troposphere.

2-7. The second subdivision of the stratosphere is characterized by rising temperatures. This area is the ozonosphere. The ozonosphere serves as a double-sided barrier that absorbs harmful solar ultraviolet radiation while allowing solar heat to pass through unaffected. In addition, the ozonosphere reflects heat from rising air masses back toward the surface of the Earth, keeping the lower regions of the atmosphere warm, even at night during the absence of significant solar activity.

**THE MESOSPHERE**

2-8. The mesosphere extends from the stratopause to an altitude of 264,050 feet (50 miles). Temperatures decline from a high of -3 degrees Celsius at the stratopause to nearly -113 degrees Celsius at the mesopause.

2-9. Noctilucent clouds are another characteristic of this atmospheric layer. Made of meteor dust/water vapor and shining only at night, these cloud formations are probably due to solar reflection.

**THE THERMOSPHERE**

2-10. The thermosphere extends from 264,050 feet (50 miles) to about 435 miles above the Earth. The uppermost atmospheric region, the thermosphere

is generally characterized by increasing temperatures; however, the temperature increase is in direct relation to solar activity. Temperatures in the thermosphere can range from  $-113$  degrees Celsius at the mesopause to  $1,500$  degrees Celsius during periods of extreme solar activity.

2-11. Another characteristic of the thermosphere is the presence of charged ionic particles. These particles are the result of high-speed subatomic particles emanating from the sun. These particles collide with gas atoms in the atmosphere and split them apart, resulting in a large number of charged particles (ions).

## COMPOSITION OF THE ATMOSPHERE

2-12. The atmosphere of the Earth is a mixture of gases. Although the atmosphere contains many gases, few are essential to human survival. Those gases required for human life are nitrogen, oxygen, and carbon dioxide. Table 2-2 indicates the percentage concentrations of gases commonly found in the atmosphere.

**Table 2-2. Percentages of Atmospheric Gases**

Gas	Symbol	Volume (%)
Nitrogen	$N_2$	78.0840
Oxygen	$O_2$	20.9480
Argon	A	0.9340
Carbon Dioxide	$CO_2$	0.0314
Neon	Ne	0.0018
Helium	He	0.0005
Hydrogen	$H_2$	<0.0001

### NITROGEN

2-13. The atmosphere of the Earth consists mainly of nitrogen. Although a vital ingredient in the chain of life, nitrogen is not readily used by the human body. However, nitrogen saturates body fluids and tissues as a result of respiration. Aircrews must be aware of possible evolved-gas disorders because of the decreased solubility of nitrogen at higher altitudes.

### OXYGEN

2-14. Oxygen is the second most plentiful gas in the atmosphere. The process of respiration unites oxygen and sugars to meet the energy requirements of the body. The lack of oxygen in the body at altitude will cause drastic physiological changes that can result in death. Therefore, oxygen is of great importance to aircrew members.

### CARBON DIOXIDE

2-15. Carbon dioxide is the product of cellular respiration in most life forms. Although not present in large amounts, the  $CO_2$  in the atmosphere plays a vital role in maintaining the oxygen supply of the Earth. Through photosynthesis, plant life uses  $CO_2$  to create energy and releases  $O_2$  as a

by-product. As a result of animal metabolism and photosynthesis, CO<sub>2</sub> and O<sub>2</sub> supplies in the atmosphere remain constant.

**OTHER GASES**

2-16. Other gases—such as argon, xenon, and helium—are present in trace amounts in the atmosphere. They are not as critical to human survival as are nitrogen, oxygen, and carbon dioxide.

**ATMOSPHERIC PRESSURE**

2-17. Standard atmospheric pressure, or barometric pressure, is the force (that is, weight) exerted by the atmosphere at any given point. An observable characteristic, atmospheric pressure can be expressed in different forms, depending on the method of measurement. Atmospheric pressure decreases with increasing altitude, making barometric pressure of great concern to aircrews because oxygen diffusion in the body depends on total barometric pressure. Figure 2-1 illustrates the standard atmospheric pressure measurements at 59 degrees Fahrenheit (15 degrees Celsius) at sea level.

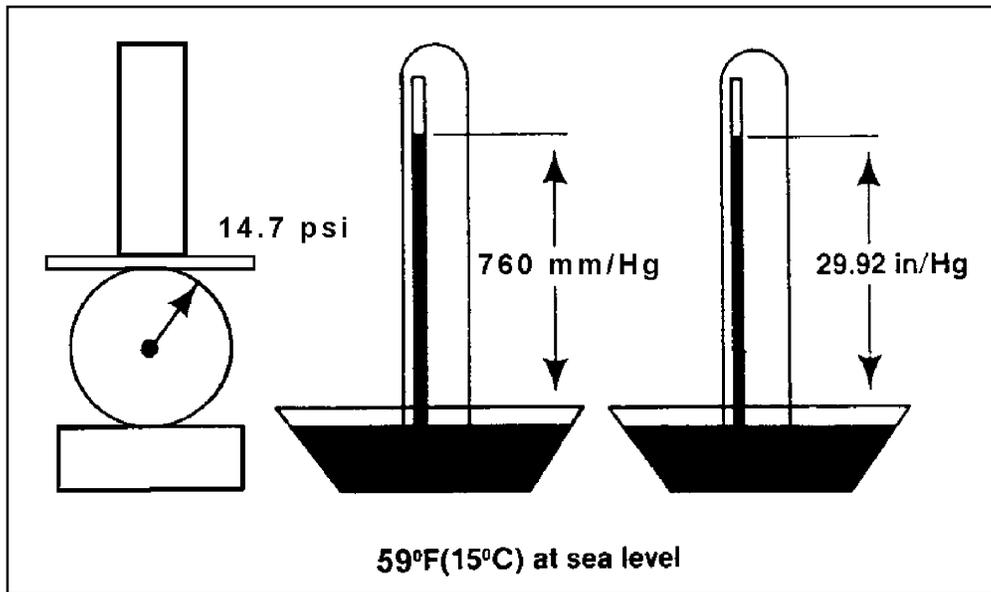

Figure 2-1. Standard Atmospheric Pressure Measurements at 59 Degrees Fahrenheit (15 Degrees Celsius) at Sea Level

**DALTON'S LAW OF PARTIAL PRESSURES**

2-18. A close relationship exists between atmospheric pressure and the amount of the various gases in the atmosphere. This relationship is referred to as Dalton's Law of Partial Pressures. Dalton's Law states that the pressure exerted by a mixture of ideal (nonreacting) gases is equal to the sum of the pressures that each gas would exert if it alone occupied the space filled by the mixture. The pressure of each gas within a gaseous mixture is independent of the pressures of the other gases in the mixture. The independent pressure of

each gas is termed the partial pressure of that gas. Figure 2-2 represents the concept of Dalton's Law as related to the atmosphere of the Earth. Mathematically, Dalton's Law can be expressed as follows:

$$P_t = P_N + P_{O_2} + P_{CO_2} + \dots \text{ (constant volume and temperature)}$$

Where  $P_t$  represents the total pressure of the mixture,  $P_N$ ,  $P_{O_2}$ ,  $P_{CO_2}$ , ... represent the partial pressures of each individual gas,  $V$  represents volume, and  $T$  represents temperature. To determine the partial pressure of the gases in the atmosphere (or any gaseous mixture whose concentrations are known), the following mathematical formula can be used:

*Percentage of atmospheric*

*concentration*

*of the individual gas*

*100*

*Total atmospheric*

*pressure at a given altitude =*

*Partial pressure of the individual gas*

2-19. Dalton's Law states that the pressure exerted by a mixture of ideal (nonreacting) gases is equal to the sum of the pressures that each gas would exert if it alone occupied the space filled by the mixture. The pressure of each gas within a gaseous mixture is independent of the pressures of the other gases in the mixture. The independent pressure of each gas is termed the partial pressure of that gas. Figure 2-2 represents the concept of Dalton's Law as related to the atmosphere of the Earth.

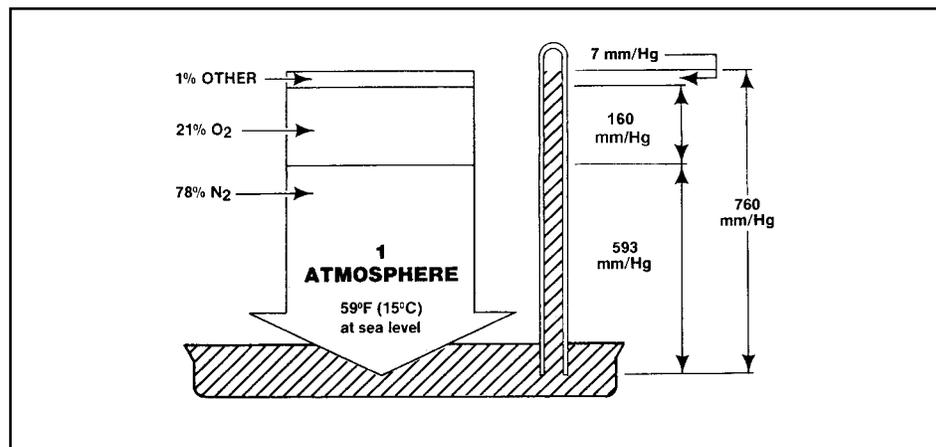

Figure 2-2. Dalton's Law of Partial Pressures as Related to the Atmosphere of the Earth

2-20. For the aircrew member, Dalton's law illustrates that increasing altitude results in a proportional decrease of partial pressures of gases found in the atmosphere. Although the percentage concentration of gases remains stable with increasing altitude, each partial pressure decreases in direct proportion to the total barometric pressure. Table 2-3 shows the relationship between barometric pressure and partial pressure.

**Table 2-3. Partial Pressures of O<sub>2</sub> at Various Altitudes**

<b>Altitude (feet)</b>	<b>Atmospheric Pressure (mm/Hg)</b>	<b>PAO<sub>2</sub> (mm/Hg)</b>	<b>PVO<sub>2</sub> (mm/Hg)</b>	<b>Pressure Differential (mm/Hg)</b>	<b>Blood Saturation (%)</b>
Sea Level	760	100	40	60	98
10,000	523	60	31	29	87
18,000	380	38	26	12	72
22,000	321	30	22	8	60
25,000	282	7	4	3	9
35,000	179	0	0	0	0

2-21. Changes in the partial pressure of oxygen dramatically affect respiratory functions within the human body. Any decrease in the partial pressure of oxygen quickly results in physiological impairment. Although this impairment may not be noticed initially at lower altitudes, the effects are cumulative and grow progressively worse as altitude increases.

2-22. Decreases in the partial pressure of nitrogen, especially at high altitude, can lead to a decrease in the solubility of N<sub>2</sub> in the body. This decrease in N<sub>2</sub> solubility can result in decompression sickness.

## **PHYSIOLOGICAL ZONES OF THE ATMOSPHERE**

2-23. Humans are unable to adapt physiologically to all of the physical changes that occur in the different regions of the atmosphere. Because man evolved on the surface, humans are especially susceptible to the dramatic temperature and pressure changes that take place during ascent and sustained aerial flight. Because of these factors, the atmosphere can be further divided (by altitude) into three distinct physiological zones. These divisions are primarily based on pressure changes that occur within these parameters and the resultant effects on human physiology.

### **THE EFFICIENT ZONE**

2-24. Extending upward from sea level to 10,000 feet, the efficient zone provides aircrews with a near-ideal physiological environment. Although the barometric pressure drops from 760 mm/Hg at sea level to 523 mm/Hg at 10,000 feet, Po<sub>2</sub> (partial pressure of oxygen) levels within this range allow humans to operate in the efficient zone without using protective equipment; however, sustained flight in the upper portions of this area may require acclimatization. Some minor problems associated with the efficient zone are ear and sinus blocks and gas expansion in the digestive tract. Also, without the use of supplemental oxygen, a decrease in night vision capabilities will occur above 4,000 feet.

### **THE DEFICIENT ZONE**

2-25. The deficient zone of the atmosphere ranges from 10,000 feet at its base to 50,000 feet at its highest point. Because atmospheric pressure at 10,000

feet is only 523 mm/Hg, missions in the deficient zone carry a high degree of risk unless supplemental-oxygen/cabin-pressurization systems are used. As flights approach the upper limit of the deficient zone, decreasing barometric pressures (down to 87 mm/Hg) make trapped-gas disorders occur more frequently.

### **THE SPACE EQUIVALENT ZONE**

2-26. Extending from 50,000 feet and continuing to the outer fringes of the atmosphere, the space equivalent zone is totally hostile to human life. Therefore, flight in the space equivalent zone requires a completely artificial atmospheric environment. Unprotected exposure to the extremely low temperatures and pressures found at these high altitudes can quickly result in death. An example of how dangerous this area can be is found at 63,000 feet (Armstrong's line). The barometric pressure at this altitude is only 47 mm/Hg, which equals the partial pressure of water in the body. At this pressure, water begins to "boil" within the body as it changes into a gaseous vapor.

## **SECTION II – CIRCULATORY SYSTEM**

### **STRUCTURE AND FUNCTION OF THE CIRCULATORY SYSTEM**

2-27. The circulatory system, shown in Figure 2-3, constitutes the physiologic framework required to transport blood throughout the body. A fundamental function of the circulatory system (along with the lymphatic system) is fluid transport. Other important functions of this system include meeting body cell nutrition and excretion demands, along with body-heat and electrochemical equilibrium requirements. Circulatory components include arteries, capillaries, and veins that stretch to nearly every cell in the body.

#### **ARTERIES**

2-28. Conducting blood away from the ventricles of the heart, the arteries are strong, elastic vessels that can withstand relatively high pressures. Arterial vessels generally carry oxygen-rich blood to the capillaries for use by the tissues.

#### **CAPILLARIES**

2-29. The body's smallest blood vessels, the capillaries, form the junction between the smallest arteries (arterioles) and the smallest veins (venules). Actually semipermeable extensions of the inner linings of the arterioles and venules, the capillaries provide body tissues with access to the bloodstream. Capillaries can be found virtually everywhere in the body, providing needed gas-/nutrient-exchange capabilities to nearly every body cell.

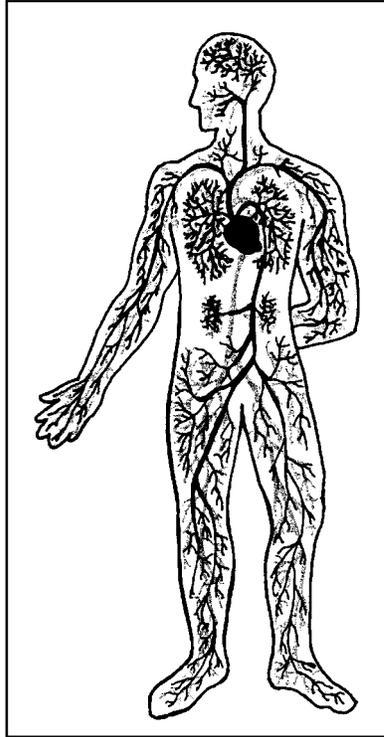

**Figure 2-3. Structures of the Circulatory System**

## **VEINS**

2-30. Transporting blood from the capillaries back to the atria of the heart, the veins are the blood-return portion of the circulatory system. A low-pressure pathway, the veins also possess flap-like valves that ensure that blood flows only in the direction of the heart. In addition, the veins can constrict or dilate, based on the body's requirements. This unique ability allows blood flow and pressure to be modified, based on such factors as body heat or trauma.

## **COMPONENTS AND FUNCTIONS OF BLOOD**

2-31. Although blood volume varies with body size, the average adult has a blood volume approaching 5 liters. About 5 percent of total body weight, blood is actually a form of connective tissue whose cells are suspended in a liquid intercellular material. The cellular portions of the blood compose about 45 percent of blood volume and consist mainly of red blood cells, white blood cells, and blood platelets. The remaining 55 percent of the blood is a liquid called plasma. Each of these components performs unique functions, summarized in Figure 2-4.

## **RED BLOOD CELLS**

2-32. Most of the body's supply of oxygen is transported by the red blood cells (erythrocytes). Because oxygenation of red blood cells depends on the  $P_{O_2}$  in

the atmosphere, aircrews may begin to suffer from oxygen deficiency (hypoxia) even at low altitudes. RBC structure, appearance, and production are among the factors that are affected when erythrocytes experience hypoxia.

2-33. Hemoglobin makes up about one-third of every red blood cell. Composed of several polypeptide chains and iron-containing heme groups, hemoglobin attracts oxygen molecules through an electrochemical magnetic process. Just as opposing poles on a magnet attract, so does the iron content ( $\text{Fe}^{2+}$ ) within hemoglobin attract oxygen ( $\text{O}_2^{2-}$ ).

2-34. When the blood supply is fully saturated with oxygen, as in arterial blood, blood takes on a bright-red color as oxyhemoglobin is formed. As blood passes through the capillaries, it releases oxygen to the surrounding tissues. As a result, deoxyhemoglobin forms and gives venous blood a dark-red color.

2-35. Red blood cells are produced in the red bone marrow. The number of RBCs in circulating blood is relatively stable; however, environmental factors play a large role in determining the actual RBC count. Smoking, an inadequate diet, and the altitude where one lives all contribute to fluctuations in RBC count. In fact, people residing above 10,000 feet may have up to 30 percent more erythrocytes than those living at sea level.

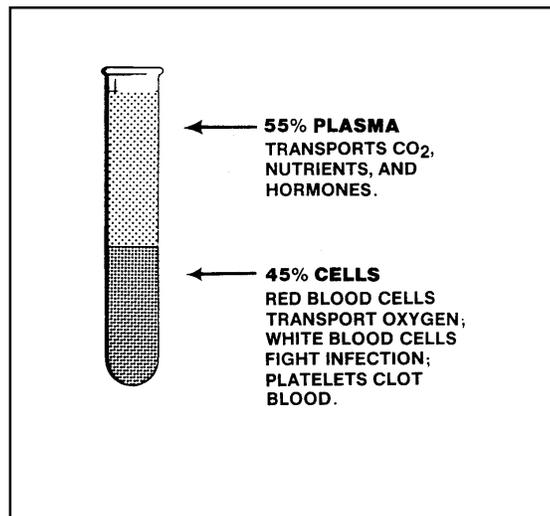

Figure 2-4. Functions of Blood Components

### WHITE BLOOD CELLS

2-36. The principal role of the white blood cells, or leukocytes, is to fight/control various disease conditions, especially those caused by invading microorganisms. Although WBCs are typically larger than RBCs, WBCs can squeeze between the cells of blood vessels to reach diseased tissues. WBCs also help form natural immunities against numerous disease processes.

## **PLATELETS**

2-37. Although not complete cells, the platelets, or thrombocytes, arise from small, fragmented portions of much larger cells produced in the red bone marrow. About half the size of an RBC, the platelets react to any breach in the circulatory system through initialization of blood coagulation and blood-vessel contraction.

## **PLASMA**

2-38. The liquid portion of the blood is a translucent, straw-colored fluid, known as plasma. All of the cellular structures in the bloodstream are suspended in this liquid. Composed mainly of water, plasma also contains proteins and inorganic salts. Some of the important functions of the plasma are to transport nutrients, such as glucose, and waste products, such as carbon dioxide.

# **SECTION III – RESPIRATORY SYSTEM**

## **THE PROCESSES OF BREATHING AND RESPIRATION**

2-39. All known living organisms exchange gases with their environment. This gas exchange is known as respiration. The processes of respiration are breathing, external respiration, and internal respiration.

### **BREATHING**

2-40. Breathing can be described as a spontaneous, rhythmic mechanical process. Contraction and relaxation of the respiratory muscles cause gases to move in and out of the lungs, thereby providing the body a gaseous media for exchange purposes.

### **EXTERNAL RESPIRATION**

2-41. External respiration takes place in the alveoli of the lungs. Air, which includes oxygen, is moved to the alveoli by the mechanical process of breathing. Once in the alveolar sacs, oxygen diffuses from the incoming air into the bloodstream. At the same time, carbon dioxide diffuses from the venous blood into the alveolar sacs.

### **INTERNAL RESPIRATION**

2-42. Internal respiration includes the use of blood oxygen and carbon dioxide production by tissue cells, as well as gas exchange between cells and the surrounding fluid medium. These mechanisms, known as the metabolic process, produce the energy needed for life.

## **FUNCTIONS OF RESPIRATION**

2-43. Respiration has several functions. It brings O<sub>2</sub> into the body, removes CO<sub>2</sub> from the body, and helps maintain the temperature and the acid-base balance of the body.

### **OXYGEN INTAKE**

2-44. The primary function of respiration is the intake of O<sub>2</sub>. Oxygen enters the body through the respiratory system and is transported within the body through the circulatory system. All body cells require oxygen to metabolize food material.

### **CARBON-DIOXIDE REMOVAL**

2-45. Carbon dioxide is one of the by-products of the metabolic process. CO<sub>2</sub> dissolves in the blood plasma, which then transports it from the tissues to the lungs so that it can be released.

### **BODY-HEAT BALANCE**

2-46. Body temperature is usually maintained within a narrow range (from 97 to 100 degrees Fahrenheit). Evaporation of bodily fluids (such as perspiration) is one method of heat loss that helps maintain body-heat balance. The warm, moist air released during exhalation also aids in this process.

### **BODY CHEMICAL BALANCE**

2-47. A delicate balance exists between the amounts of oxygen and carbon dioxide in the body. The uptake of O<sub>2</sub> and CO<sub>2</sub> takes place through extensive chemical changes in the hemoglobin and plasma of the blood. Disrupting these chemical pathways changes the chemical balance of the body.

2-48. Under normal conditions, the measure of relative acidity or alkalinity (pH level) within the body is 7.35 to 7.45. During respiration, the partial pressure of carbon dioxide elevates, the acidity level increases, and the pH value lowers to less than 7.3. Conversely, too little CO<sub>2</sub> causes the blood to become more alkaline and the pH value to rise. Figure 2-5 shows how the amount of carbon dioxide in the body affects the pH level of the blood.

2-49. Because the human body maintains equilibrium within narrow limits, the respiratory centers of the brain sense any shift in the blood pH and partial pressure of CO<sub>2</sub> (Pco<sub>2</sub>) levels. When unusual levels occur, chemical receptors trigger the respiratory process to help return the Pco<sub>2</sub> and pH levels to normal limits. The 7.2 to 7.6 limits are critical for the necessary uptake of O<sub>2</sub> by the blood and the release of that O<sub>2</sub> to tissues.

### **PHASES OF EXTERNAL RESPIRATION**

2-50. The respiratory cycle is an involuntary process that continues unless a conscious effort is made to control it. External respiration occurs in two phases: active (inhalation) and passive (exhalation). Figure 2-6 illustrates these phases.

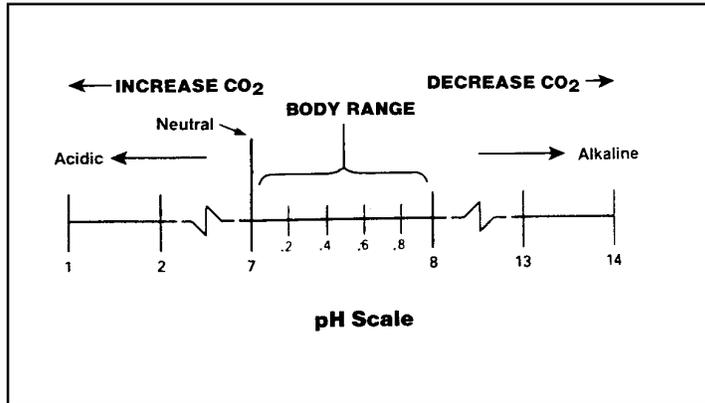

Figure 2-5. Relationship of CO<sub>2</sub> Content and pH Level of the Blood

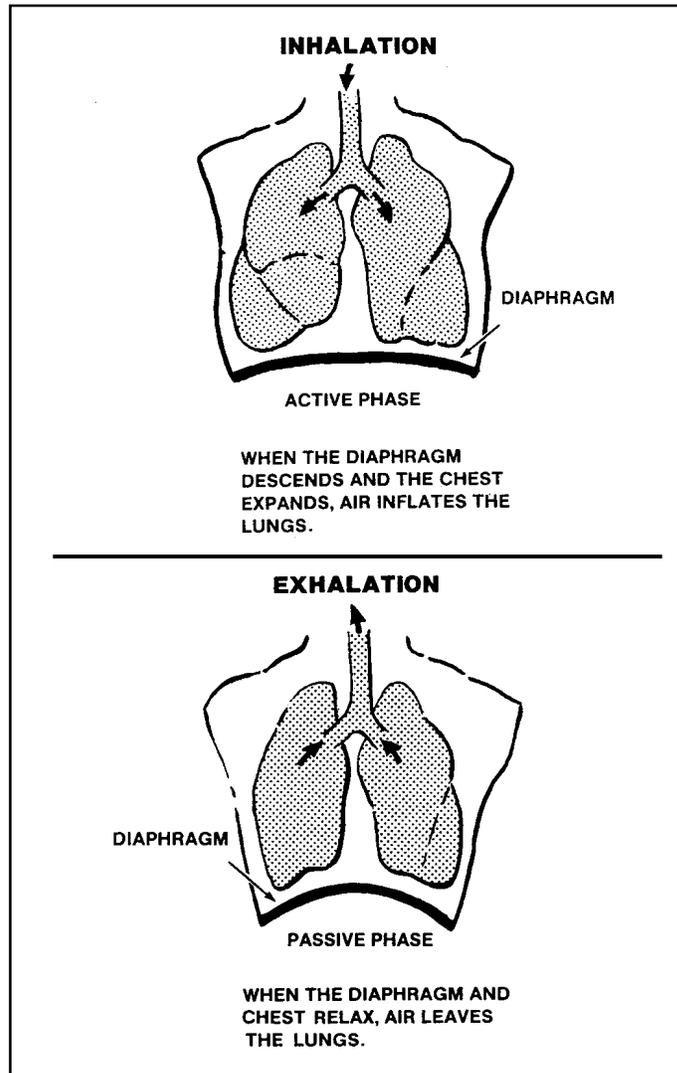

Figure 2-6. The Phases of Respiration

**ACTIVE PHASE (INHALATION)**

2-51. The movement of air into the lungs is the active phase of external respiration, or inhalation. It is caused by the expansion of the chest wall and downward motion of the diaphragm. Inhalation creates an area of low pressure because of the increased volume in the lungs. Because of the greater outside pressure, air will then rush into the lungs to inflate them.

**PASSIVE PHASE (EXHALATION)**

2-52. In the passive phase of external respiration, or exhalation, the diaphragm relaxes and the chest wall contracts downward to create increased pressure inside the lungs. Once the glottis opens, this pressure inside the lungs causes the air to rush out, which frees CO<sub>2</sub> to the atmosphere.

**COMPONENTS OF THE RESPIRATORY SYSTEM**

2-53. The respiratory system consists of passages and organs that bring atmospheric air into the body. The components of the respiratory system, shown in Figure 2-7, include the oral-nasal passage, pharynx, larynx, trachea, bronchi, bronchioles, alveolar ducts, and alveoli.

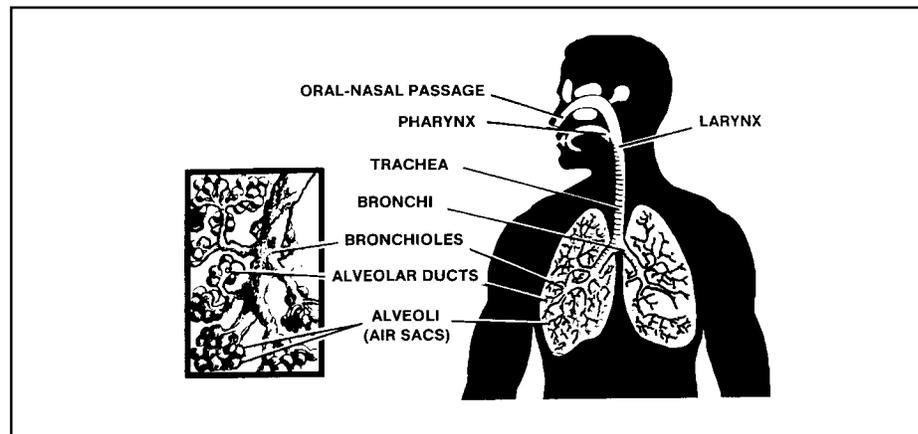

Figure 2-7. Components of the Respiratory System

**ORAL-NASAL PASSAGE**

2-54. The oral-nasal passage includes the mouth and nasal cavities. The nasal passages are lined with a mucous membrane that contains many fine, ciliated hair cells. The membrane's primary purpose is to filter air as it enters the nasal cavity. The hairs continually clean the membrane by sweeping filtered material to the back of the throat where it is either swallowed or expelled through the mouth. Therefore, air that enters through the nasal cavity is better filtered than air that enters through the mouth.

**PHARYNX**

2-55. The pharynx, the back of the throat, is connected to the nasal and oral cavities. It primarily humidifies and warms the air entering the respiratory system.

**TRACHEA**

2-56. The trachea, or windpipe, is a tube through which air moves down into the bronchi. From there, air continues to move down increasingly smaller passages, or ducts, until it reaches the small alveoli within the lung tissue.

**ALVEOLI**

2-57. Each tiny alveolus is surrounded by a network of capillaries that joins veins and arteries. The microscopic capillaries, each having a wall only one cell in thickness, are so narrow that red blood cells move through them in single file. The actual gaseous exchange between CO<sub>2</sub> and O<sub>2</sub> occurs in the alveoli.

2-58. Carbon dioxide and oxygen move in and out of alveoli because of the pressure differentials between their CO<sub>2</sub> and O<sub>2</sub> levels and those in surrounding capillaries. This movement is based on the law of gaseous diffusion: a gas always moves from an area of high pressure to an area of lower pressure. Figure 2-8 illustrates the exchange of CO<sub>2</sub> and O<sub>2</sub> between an alveolus and a capillary.

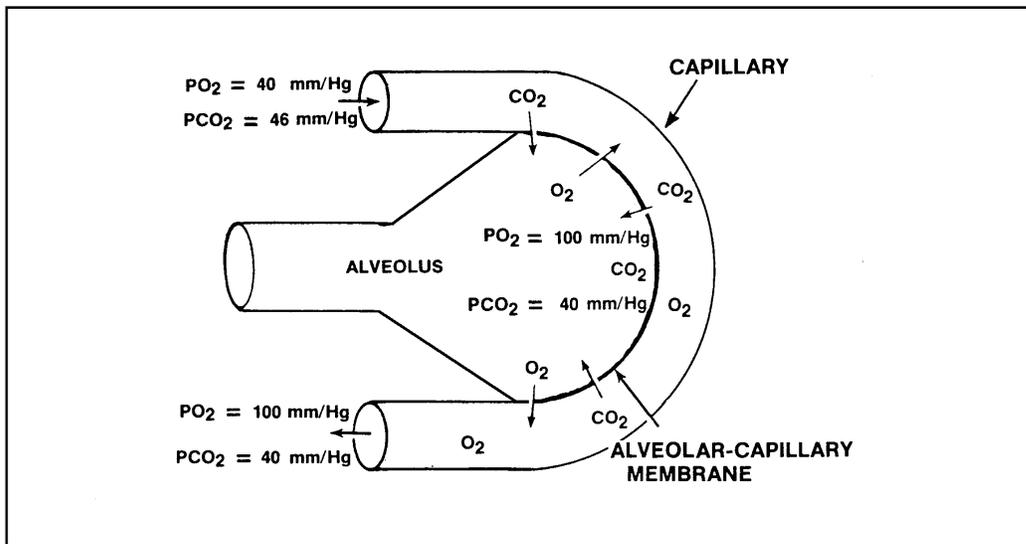

**Figure 2-8. Diffusion of CO<sub>2</sub> and O<sub>2</sub> Between an Alveolus and a Capillary**

2-59. When O<sub>2</sub> reaches the alveoli of the lungs, it crosses a thin cellular barrier and moves into the capillary bed to reach the oxygen-carrying RBCs. As the oxygen enters the alveoli, it has a partial pressure of oxygen of about 100 mm/Hg. Within the blood, the P<sub>o</sub><sub>2</sub> of the venous return blood is about 40 mm/Hg. As the blood traverses the capillary networks of the alveoli, the O<sub>2</sub> flows from the area of high pressure within the alveoli to the area of low pressure within the blood. Thus, O<sub>2</sub> saturation takes place.

2-60. Carbon dioxide diffuses from the blood to the alveoli in the same manner. The partial pressure of carbon dioxide (P<sub>c</sub><sub>o</sub><sub>2</sub>) in the venous return blood of the capillaries is about 46 mm/Hg, as compared to a P<sub>c</sub><sub>o</sub><sub>2</sub> of 40

mm/Hg in the alveoli. As the blood moves through the capillaries, the  $\text{CO}_2$  moves from the high  $\text{Pco}_2$  in the capillaries to an area of lower  $\text{Pco}_2$  in the alveoli. The  $\text{CO}_2$  is then exhaled during the next passive phase (exhalation) of respiration.

**Note:** The exchange of  $\text{O}_2$  and  $\text{CO}_2$  between tissue and capillaries occurs in the same manner as it does between the alveoli and capillaries. Figure 2-9 shows the exchange between tissue and a capillary.

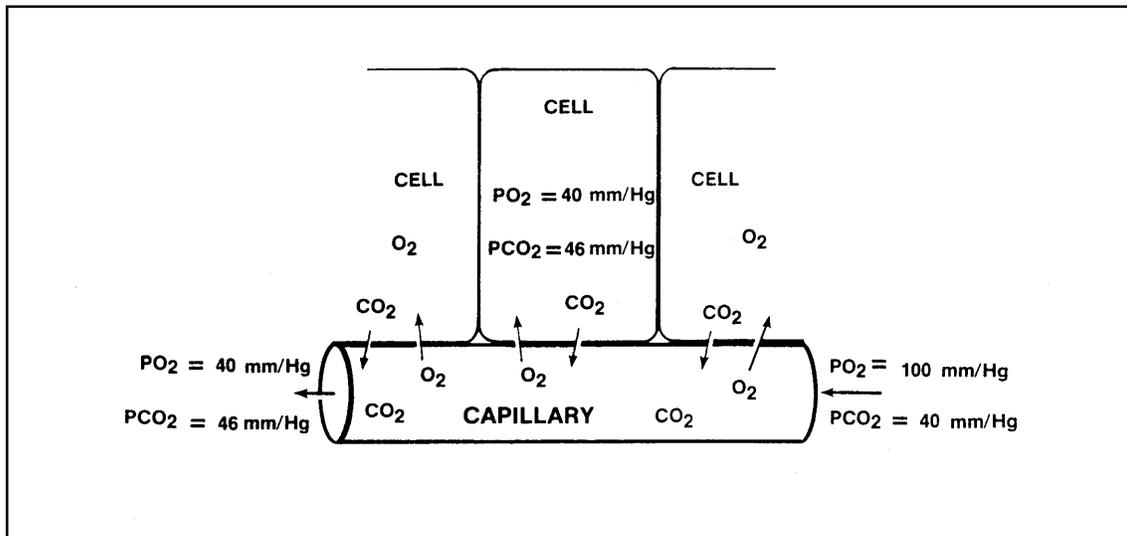

Figure 2-9. Diffusion of  $\text{CO}_2$  and  $\text{O}_2$  Between Tissue and a Capillary

2-61. The amount of  $\text{O}_2$  and  $\text{CO}_2$  transferred across the alveolar-capillary membrane into the blood depends primarily on the alveolar pressure of oxygen in relation to the venous pressure of oxygen. This pressure differential is critical to the crew member because  $\text{O}_2$  saturation in the blood decreases as altitude increases. This decrease in  $\text{O}_2$  saturation can lead to hypoxia, which is caused by a deficiency of  $\text{O}_2$  in the body tissues. Table 2-4 shows the relationship between altitude and  $\text{O}_2$  saturation.

Table 2-4. Correlation of Altitude and Blood  $\text{O}_2$  Saturation

Altitude (feet)	Atmospheric Pressure (mm/Hg)	$\text{PAO}_2$ (mm/Hg)	$\text{PVO}_2$ (mm/Hg)	Pressure Differential (mm/Hg)	Blood Saturation (%)
Sea Level	760	100	40	60	98
10,000	523	60	31	29	87
18,000	380	38	26	12	72
22,000	321	30	22	8	60
25,000	282	7	4	3	9
35,000	179	0	0	0	0

## SECTION IV – HYPOXIA

### CHARACTERISTICS OF HYPOXIA

2-62. Hypoxia results when the body lacks oxygen. Hypoxia tends to be associated only with flights at high altitude. However, many other factors—such as alcohol abuse, heavy smoking, and various medications—interfere with the blood’s ability to carry oxygen. These factors can either diminish the ability of the blood to absorb oxygen or reduce the body’s tolerance to hypoxia.

### TYPES OF HYPOXIA

2-63. There are four major types of hypoxia: hypoxic, hypemic, stagnant, and histotoxic. They are classified according to the cause of the hypoxia.

#### HYPOXIC HYPOXIA

2-64. Hypoxic hypoxia occurs when not enough oxygen is in the air or when decreasing atmospheric pressures prevent the diffusion of O<sub>2</sub> from the lungs to the bloodstream. Aviation personnel are most likely to encounter this type at altitude. It is due to the reduction of the P<sub>o2</sub> at high altitudes, as shown in Figure 2-10.

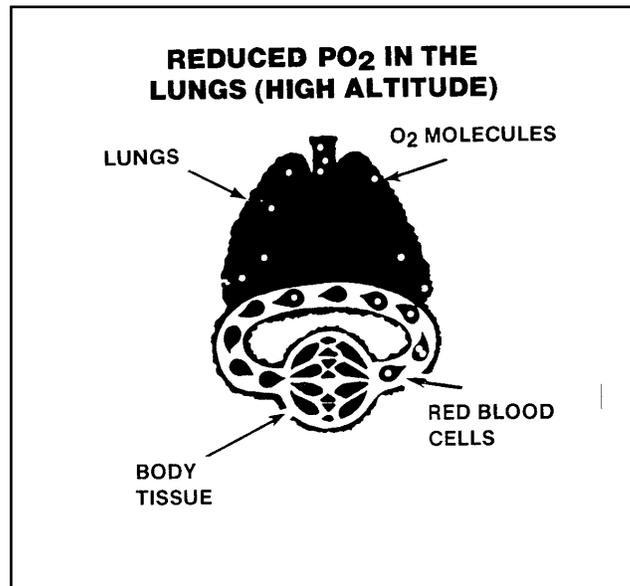

Figure 2-10. Hypoxic Hypoxia

#### HYPEMIC HYPOXIA

2-65. Hypemic, or anemic, hypoxia is caused by a reduction in the oxygen-carrying capacity of the blood, as shown in Figure 2-11. Anemia and blood loss are the most common causes of this type. Carbon monoxide, nitrites, and sulfa drugs also cause this hypoxia by forming compounds with hemoglobin and reducing the hemoglobin that is available to combine with oxygen.

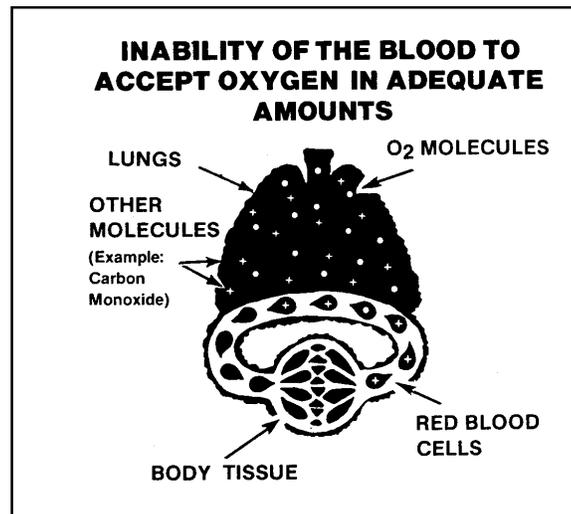

Figure 2-11. Hypemic Hypoxia

**STAGNANT HYPOXIA**

2-66. In stagnant hypoxia, the oxygen-carrying capacity of the blood is adequate but, as shown in Figure 2-12, circulation is inadequate. Such conditions as heart failure, arterial spasm, and occlusion of a blood vessel predispose the individual to stagnant hypoxia. More often, when a crew member experiences extreme gravitational forces, disrupting blood flow and causing the blood to stagnate.

**HISTOTOXIC HYPOXIA**

2-67. This type results when there is interference with the use of  $O_2$  by body tissues. Alcohol, narcotics, and certain poisons—such as cyanide—interfere with the cells' ability to use an adequate supply of oxygen. Figure 2-13 shows the result of this oxygen deprivation.

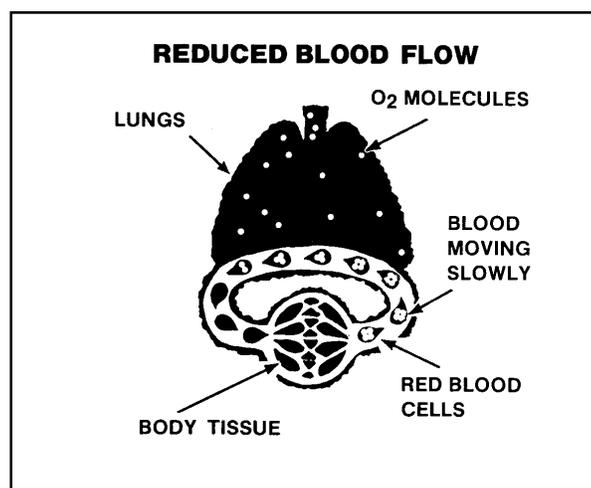

Figure 2-12. Stagnant Hypoxia

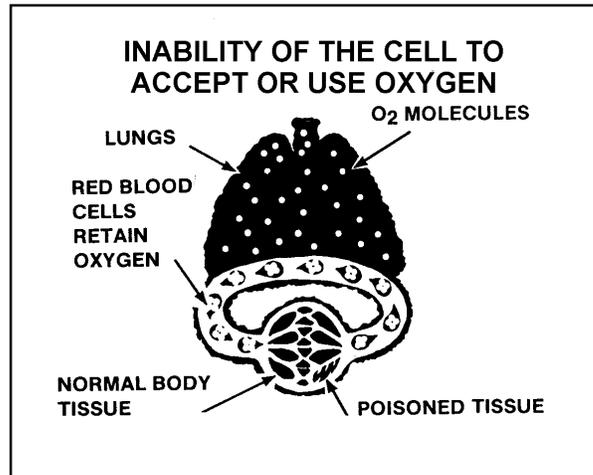

Figure 2-13. Histotoxic Hypoxia

## SIGNS, SYMPTOMS, AND SUSCEPTIBILITY TO HYPOXIA

### SIGNS AND SYMPTOMS OF HYPOXIA

2-68. Signs are observable by the other aircrew members and, therefore, are objective. Individual aircrew members observe or feel their own symptoms. These symptoms vary from one person to another and, therefore, are subjective.

2-69. Aviation personnel commonly experience mild hypoxia at altitudes at or above 10,000 feet. Those who fly must be able to recognize the possible signs and symptoms. Being able to recognize these signs and symptoms is particularly important because the onset of hypoxia is subtle and produces a false sense of well-being. Crew members are often engrossed in flight activities and do not readily notice the symptoms of hypoxia. Usually, however, most individuals experience two or three unmistakable symptoms or signs that cannot be overlooked. Figure 2-14 lists the signs and symptoms.

Symptoms (Subjective)	Signs (Objective)
Air Hunger	Hyperventilation
Apprehension	Cyanosis
Fatigue	Mental Confusion
Headache	Poor Judgment
Dizziness	Muscle Incoordination
Hot and Cold Flashes	
Euphoria	
Belligerence	
Blurred Vision	
Tunnel Vision	
Numbness	
Tingling	

▶ UNCONSCIOUSNESS ◀

Figure 2-14. Possible Signs and Symptoms of Hypoxia

## SUSCEPTIBILITY TO HYPOXIA

2-70. Individuals vary widely in their susceptibility to hypoxia. Several factors determine individual susceptibility.

### Onset Time and Severity

2-71. The onset time and severity of hypoxia vary with the amount of oxygen deficiency. Crew members must be able to recognize hypoxia and immediately determine the cause.

### Self-Imposed Stress

2-72. **Physiological Altitude.** An individual's physiological altitude, the altitude that the body feels, is as important as the true altitude of a flight. Self-imposed stressors, such as tobacco and alcohol, increase the physiological altitude.

2-73. **Smoking.** The hemoglobin molecules of RBCs have a 200- to 300-times greater affinity for carbon monoxide than for oxygen. Cigarette smoking significantly increases the amount of CO carried by the hemoglobin of RBCs; thus, it reduces the capacity of the blood to combine with oxygen. Smoking 3 cigarettes in rapid succession or 20 to 30 cigarettes within 24 hours before a flight may saturate from 8 to 10 percent of the hemoglobin in the blood. The physiological effects of this condition include—

- The loss of about 20 percent of the smoker's night vision at sea level.
- A physiological altitude of 5,000 feet at sea level, as depicted in Figure 2-15.

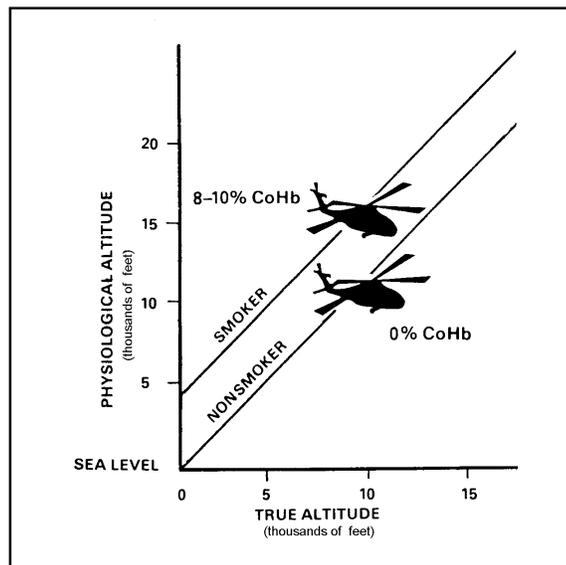

Figure 2-15. Adverse Effects of Altitude on Smokers

2-74. **Alcohol.** Alcohol creates histotoxic hypoxia. For example, an individual who has consumed 1 ounce of alcohol may have a physiological altitude of 2,000 feet.

### **Individual Factors**

2-75. Metabolic rate, diet, nutrition, and emotions greatly influence an individual's susceptibility to hypoxia. These and other individual factors must be considered in determining susceptibility.

### **Ascent Rate**

2-76. Rapid ascent rates affect the individual's susceptibility to hypoxia. High altitudes can be reached before the crew member notices serious symptoms.

### **Exposure Duration**

2-77. The effects of exposure to altitude relate directly to an individual's length of exposure. Usually, the longer the exposure, the more detrimental the effects. However, the higher the altitude, the shorter the exposure time required before symptoms of hypoxia occur.

### **Ambient Temperature**

2-78. Extremes in temperature usually increase the metabolic rate of the body. A temperature change increases the individual's oxygen requirements while decreasing the tolerance of the body to hypoxia. With these conditions, hypoxia may develop at lower altitudes than usual.

### **Physical Activity**

2-79. When physical activity increases, the body demands a greater amount of oxygen. This increased oxygen demand causes a more rapid onset of hypoxia.

### **Physical Fitness**

2-80. An individual who is physically conditioned will normally have a higher tolerance to altitude problems than one who is not. Physical fitness raises an individual's tolerance ceiling.

## **EFFECTS OF HYPOXIA**

2-81. In aviation, the most important effects of hypoxia are those related, either directly or indirectly, to the nervous system. Nerve tissue has a heavy requirement for oxygen. Brain tissue is one of the first areas affected by an oxygen deficiency. A prolonged or severe lack of oxygen destroys brain cells. Hypoxia demonstrations in an altitude chamber do not produce any known brain damage because the severity and duration of the hypoxia are minimized.

2-82. The expected performance time is from the interruption of the oxygen supply until the crew member loses the ability to take corrective action. Table 2-5 shows that the EPT varies with the altitude at which the individual is flying. An aircrew flying in a pressurized aircraft that loses cabin

pressurization, as in rapid decompression, has only one-half of the EPT shown in Table 2-5.

**Table 2-5. Relationship Between Expected Performance Time and Altitude**

Altitude (feet)	Expected Performance Time
>50,000	9–12 seconds
43,000	9–12 seconds
35,000	30–60 seconds
25,000	4–6 minutes
22,000	8–10 minutes
18,000	20–30 minutes

## STAGES OF HYPOXIC HYPOXIA

2-83. There are four stages of hypoxic hypoxia: indifferent, compensatory, disturbance, and critical. Table 2-6 shows that the stages vary according to the altitude and the severity of symptoms.

### INDIFFERENT STAGE

2-84. Mild hypoxia in this stage causes night vision to deteriorate at about 4,000 feet. Aircrew members who fly above 4,000 feet at night should be aware that visual acuity decreases significantly in this stage because of both the dark conditions and the developing mild hypoxia.

**Table 2-6. Stages of Hypoxia**

Stages	Indifferent Stage (98%–90% O <sub>2</sub> saturation)	Compensatory Stage (89%–80% O <sub>2</sub> saturation)	Disturbance Stage (79%–70% O <sub>2</sub> saturation)	Critical Stage (69%–60% O <sub>2</sub> saturation)
Altitude (thousands of feet)	0–10	10–15	15–20	20–25
Symptoms	Decrease in night vision	Drowsiness Poor judgment Impaired coordination Impaired efficiency	Impaired flight control Impaired handwriting Impaired speech Decreased coordination Impaired vision Decreased sensation to pain Impaired intellectual function Decreased memory Impaired judgment	Circulatory failure CNS failure Convulsions Cardiovascular collapse Death

### **COMPENSATORY STAGE**

2-85. The circulatory system and, to a lesser degree, the respiratory system provide some defense against hypoxia at this stage. The pulse rate, systolic blood pressure, circulation rate, and cardiac output increase. Respiration increases in depth and sometimes in rate. At 12,000 to 15,000 feet, however, the effects of hypoxia on the nervous system become increasingly apparent. After 10 to 15 minutes, impaired efficiency is obvious. Crew members may become drowsy and make frequent errors in judgment. They may also find it difficult to do even simple tasks requiring alertness or moderate muscular coordination. Crew members preoccupied with duties can easily overlook hypoxia at this stage.

### **DISTURBANCE STAGE**

2-86. In this stage, the physiological responses can no longer compensate for the oxygen deficiency. Occasionally, crew members become unconscious from hypoxia without undergoing the subjective symptoms described in Table 2-6. Fatigue, sleepiness, dizziness, headache, breathlessness, and euphoria are the symptoms most often reported. The objective symptoms explained below are also experienced.

#### **Senses**

2-87. Peripheral vision and central vision are impaired, and visual acuity is diminished. Weakness and loss of muscular coordination are experienced. The sensations of touch and pain are diminished or lost. Hearing is one of the last senses to be lost.

#### **Mental Processes**

2-88. Intellectual impairment is an early sign that often prevents the individual from recognizing disabilities. Thinking is slow, and calculations are unreliable. Short-term memory is poor, and judgment—as well as reaction time—is affected.

#### **Personality Traits**

2-89. There may be a display of basic personality traits and emotions much the same as with alcoholic intoxication. Euphoria, aggressiveness, overconfidence, or depression can occur.

#### **Psychomotor Functions**

2-90. Muscular coordination is decreased, and delicate or fine muscular movements may be impossible. Stammering and illegible handwriting are typical of hypoxic impairment.

#### **Cyanosis**

2-91. When cyanosis occurs, the skin becomes bluish in color. This effect is caused by oxygen molecules failing to attach to hemoglobin molecules.

**CRITICAL STAGE**

2-92. Within three to five minutes, judgment and coordination usually deteriorate. Subsequently, mental confusion, dizziness, incapacitation, and unconsciousness occur.

**PREVENTION OF HYPOXIC HYPOXIA**

2-93. An understanding of the causes and types of hypoxia assists in its prevention. Hypoxic (altitude) hypoxia is the type most often encountered in aviation. The other three types (hypemic, stagnant, and histotoxic) may also present danger to aviators.

2-94. Hypoxic hypoxia can be prevented by ensuring that sufficient oxygen is available to maintain an alveolar partial pressure of oxygen (PA<sub>O<sub>2</sub></sub>) between 60 and 100 mm/Hg. Preventive measures include—

- Limiting the time at altitude.
- Using supplemental oxygen.
- Pressurizing the cabin.

2-95. During night flights above 4,000 feet, crew members should use supplemental oxygen when available. Supplemental oxygen is necessary because of the mild hypoxia and loss of visual acuity that occur.

2-96. The amount, or percentage, of oxygen required to maintain normal oxygen saturation levels varies with altitude. At sea level, a 21 percent concentration of ambient air oxygen is necessary to maintain the normal blood oxygen saturation of 96 to 98 percent. At 20,000 feet, however, a 49 percent concentration of oxygen is required to maintain the same saturation.

2-97. The upper limit of continuous-flow oxygen is reached at about 34,000 feet. Above 34,000 feet, positive pressure is necessary to maintain an adequate oxygen saturation level. The positive pressure, however, cannot exceed 30 mm/Hg because—

- Normal oxygen masks cannot hold positive pressures of more than 25 mm/Hg without leaking.
- Excess pressure may enter the middle ear through the eustachian tubes and cause the eardrum to bulge outward, which is painful.
- Crew members encounter difficulty in exhalation against the pressure, resulting in hyperventilation.

2-98. Pressurization, as found in the C-12 aircraft, can prevent hypoxia. Supplemental oxygen should be available in the aircraft in case of pressurization loss.

2-99. The prevention of hypoxic hypoxia is essential in the aviation environment. There are, however, other causes of hypoxia. Carbon monoxide uptake (hypemic hypoxia), the effects of alcohol (histotoxic hypoxia), and reduced blood flow (stagnant hypoxia) are also hazardous. Avoiding or minimizing self-imposed stressors helps eliminate hypoxic conditions.

## **TREATMENT OF HYPOXIA**

2-100. Individuals who exhibit signs and symptoms of hypoxia must be treated immediately. Treatment consists of giving the individual 100 percent oxygen. If oxygen is not available, descent to an altitude below 10,000 feet is mandatory. When symptoms persist, the type and cause of the hypoxia must be determined and treatment administered accordingly.

## **SECTION V – HYPERVENTILATION**

### **CHARACTERISTICS OF HYPERVENTILATION**

2-101. Hyperventilation is the excessive rate and depth of respiration leading to abnormal loss of carbon dioxide from the blood. This condition occurs more often among aviators than is generally recognized. It seldom incapacitates completely, but it causes disturbing symptoms that can alarm the uninformed aviator. In such cases, an increased breathing rate and anxiety then further aggravate the problem.

### **CAUSES OF HYPERVENTILATION**

2-102. The human body reacts automatically under conditions of stress and anxiety whether the problem is real or imaginary. Often, a marked increase in breathing rate occurs. This increase leads to a significant decrease in the carbon-dioxide content of the body as well as a change in the acid-base balance. Among the factors that can initiate this cycle are emotions, pressure breathing, and hypoxia.

#### **EMOTIONS**

2-103. When fear, anxiety, or stress alters the normal breathing pattern, the individual may attempt to consciously control breathing. The respiration rate is then likely to increase without an elevation in CO<sub>2</sub> production, and hyperventilation occurs.

#### **PRESSURE BREATHING**

2-104. Positive-pressure breathing is used to prevent hypoxia at altitude. It reverses the normal respiratory cycle of inhalation and exhalation.

#### **Inhalation**

2-105. Under positive-pressure conditions, the aviator is not actively involved in inhalation as in the normal respiratory cycle. The aviator does not inhale oxygen into the lungs; instead, oxygen is forced into the lungs under positive pressure.

#### **Exhalation**

2-106. Under positive-pressure conditions, the aviator is forced to breathe out against the pressure. The force that the individual must exert in exhaling results in an increased rate and depth of breathing. At this point, too much CO<sub>2</sub> is lost and alkalosis, or increased pH, occurs. Pauses between exhaling

and inhaling can reverse this condition and maintain a near-normal level of CO<sub>2</sub> during pressure breathing.

## **HYPOXIA**

2-107. With the onset of hypoxia and the resultant lower oxygen-saturation level of the blood, the respiratory center triggers an increase in the breathing rate to gain more oxygen. This rapid breathing, which is beneficial for oxygen uptake, causes excessive loss of carbon dioxide when continued too long.

## **SIGNS AND SYMPTOMS OF HYPERVENTILATION**

2-108. The excessive loss of CO<sub>2</sub> and the chemical imbalance that occur during hyperventilation produce signs and symptoms. These include—

- Dizziness.
- Muscle spasms.
- Unconsciousness.
- Visual impairment.
- Tingling sensations.
- Hot and cold sensations.

The signs and symptoms of hyperventilation and hypoxia are similar, making them difficult to differentiate. The indications given below help to distinguish between the two.

### **Hyperventilation**

2-109. Hyperventilation results in nerve and muscle irritability and muscle spasms. Symptoms appear gradually.

### **Fainting**

2-110. Fainting produces loose muscles but no muscle spasms. Symptoms appear rapidly.

## **TREATMENT OF HYPERVENTILATION**

2-111. The most effective method of treatment is voluntary reduction in the affected individual's rate of respiration. However, an extremely apprehensive person may not respond to directions to breathe more slowly.

2-112. Although it is difficult, an individual affected by the symptoms of hyperventilation should try to control the respiration rate; the normal rate is 12 to 16 breaths per minute. To treat hyperventilation, the aviator should control breathing and go to 100 percent oxygen. If symptoms continue and conscious control of respiration is not possible, the individual should talk or sing. It is physiologically impossible to talk and hyperventilate at the same time. Talking or singing will elevate the CO<sub>2</sub> level and help regulate breathing.

2-113. When hypoxia and hyperventilation occur concurrently, a decrease in the respiratory rate and the intake of 100 percent O<sub>2</sub> will correct the

condition. If hypoxia is severe, the aviator must return to ground level before becoming incapacitated.

## SECTION VI – PRESSURE-CHANGE EFFECTS

### DYSBARISM

2-114. The human body can withstand enormous changes in barometric pressure as long as air pressure in the body cavities equals ambient air pressure. Difficulty occurs when the expanding gas cannot escape so that ambient and body pressures can equalize. The discussion in this section applies to nonpressurized flight and direct exposure of aircrews to potentially harmful altitudes.

2-115. Dysbarism refers to the various manifestations of gas expansion induced by decreased barometric pressure. These manifestations can be just as dangerous, if not more so, than hypoxia or hyperventilation. The direct effects of decreased barometric pressure can be divided into two groups: trapped-gas disorders and evolved-gas disorders.

### TRAPPED-GAS DISORDERS

2-116. During ascent, the free gas normally present in various body cavities expands. If the escape of the expanded volume is impeded, pressure builds up within the cavity and pain is experienced. The expansion of trapped gases accounts for abdominal pain, ear pain, sinus pain, or toothache.

### BOYLE'S LAW

2-117. Trapped-gas problems are explained by the physical laws governing the behavior of gases under conditions of changing pressure. Boyle's Law (Figure 2-16) states that the volume of a gas is inversely proportional to the pressure exerted upon it. Differences in gas expansion are found under conditions of dry gas and wet gas.

#### Dry-Gas Conditions

2-118. Under dry-gas conditions, the atmosphere is not saturated with moisture. Under conditions of constant temperature and increased altitude, the volume of a gas expands as the pressure decreases.

#### Wet-Gas Conditions

2-119. Gases within the body are saturated with water vapor. Under constant temperature and at the same altitude and barometric pressure, the volume of wet gas is greater than the volume of dry gas.

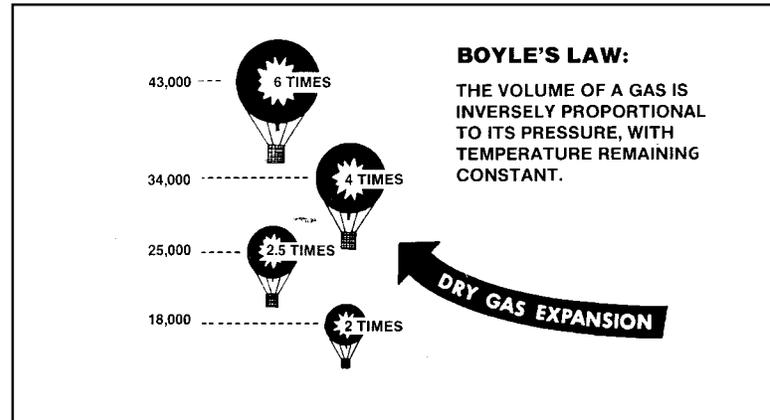

Figure 2-16. Boyle's Law

### TRAPPED-GAS DISORDERS OF THE GASTROINTESTINAL TRACT

2-120. With a rapid decrease in atmospheric pressure, aircrews frequently experience discomfort from gas expansion within the digestive tract. At low or intermediate altitudes, the symptom is not serious in most individuals. Above 25,000 feet, however, enough distension may occur to produce severe pain. Figure 2-17 shows the dramatic expansion of trapped gas as altitude increases.

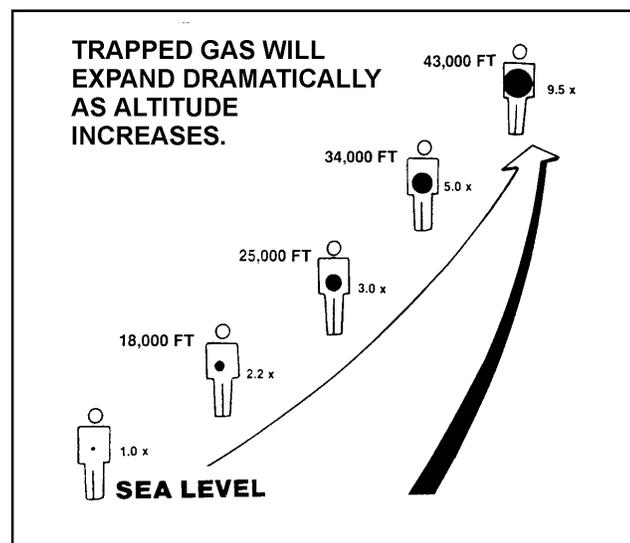

Figure 2-17. Trapped-Gas Expansion in the Gastrointestinal Tract at Increased Altitudes

#### Cause

2-121. The stomach and the small and large intestines normally contain a variable amount of gas at a pressure roughly equal to the surrounding atmospheric pressure. The stomach and large intestine contain considerably more gas than does the small intestine. The chief sources of this gas are swallowed air and, to a lesser degree, gas formed as a result of digestive processes, fermentation, bacterial decomposition, and decomposition of food

undergoing digestion. The gases normally present in the gastrointestinal tract are oxygen, carbon dioxide, nitrogen, hydrogen, methane, and hydrogen sulfide. The proportions vary, but the highest percentage of the gas mixture is always nitrogen.

### **Effects**

2-122. The absolute volume or location of the gas may cause gastrointestinal pain at high altitude. Sensitivity or irritability of the intestine, however, is a more important cause of gastrointestinal pain. Therefore, an individual's response to high altitude varies, depending on such factors as fatigue, apprehension, emotion, and general physical condition. Gas pains of even moderate severity may produce marked lowering of blood pressure and loss of consciousness if distension is not relieved. For this reason, any individual experiencing gas pains at altitude should be watched for pallor or other signs of fainting. If these signs are noted, an immediate descent should be made.

### **Prevention**

2-123. Aircrews should maintain good eating habits to prevent gas pains at high altitudes. Some foods that commonly produce gas are onions, cabbages, raw apples, radishes, dried beans, cucumbers, and melons. Crew members who participate regularly in high-altitude flights should avoid foods that disagree with them. Chewing the food well is also important. When people drink liquids or chew gum, they unavoidably swallow air. Therefore, crew members should avoid drinking large quantities of liquids, particularly carbonated beverages, before high-altitude missions and chewing gum during ascent. Eating irregularly, hastily, or while working makes individuals more susceptible to gas pains. Crew members who fly frequent, long, and difficult high-altitude missions should be given special consideration in diet and in the environment in which they eat. They should watch their diet, chew food well, and keep regular bowel habits.

### **Relief**

2-124. If trapped-gas problems exist in the gastrointestinal tract at high altitude, belching or passing flatus will ordinarily relieve the gas pains. If pain persists, descent to a lower altitude is necessary.

## **TRAPPED-GAS DISORDERS OF THE EARS**

2-125. The ear is not only an organ of hearing but also one of regulating equilibrium. When ascending to altitude, aircrew members often experience physiological discomfort during changes in atmospheric pressure. As barometric pressure decreases during ascent, the expanding air in the middle ear (Figure 2-18) is intermittently released through the eustachian tube (slender tube between the middle ear and the pharynx) into the nasal passages. As the inside pressure increases, the eardrum bulges until an excess pressure of about 12 to 15 mm/Hg is reached. At this time, the air trapped in the middle ear is forced out of the middle ear and the eardrum resumes its normal position. Just before the air escapes into the eustachian tube, there is a sensation of fullness in the ear. As the pressure is released, there is often a click or pop.

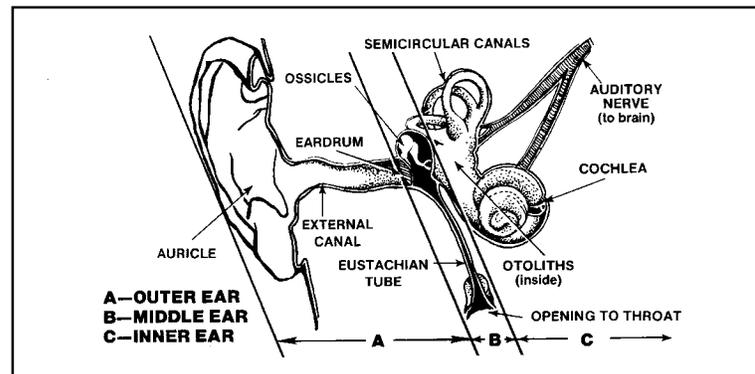

Figure 2-18. Anatomy of the Ear

## Cause

2-126. **During flight.** During descent, the change in pressure within the ear may not occur automatically. Equalizing the pressure in the middle ear with that of the outside air may be difficult. The eustachian tube allows air to pass outward easily but resists passage in the opposite direction. With the increase in barometric pressure during descent, the pressure of the external air is higher than the pressure in the middle ear and the eardrum is pushed in (Figure 2-19). If the pressure differential increases appreciably, it may be impossible to open the eustachian tube. This painful condition could cause the eardrum to rupture because the eustachian tube cannot equalize the pressure. When the ears cannot be cleared, marked pain ensues. If the pain increases with further descent, ascending to a level at which the pressure can be equalized provides the only relief. Then a slow descent is recommended. Descending rapidly from a level of 30,000 to 20,000 feet will often cause no discomfort; a rapid descent from 15,000 to 5,000 feet, however, will cause great distress. The change in barometric pressure is much greater in the latter situation. For this reason, special care is necessary during rapid descents at low altitudes.

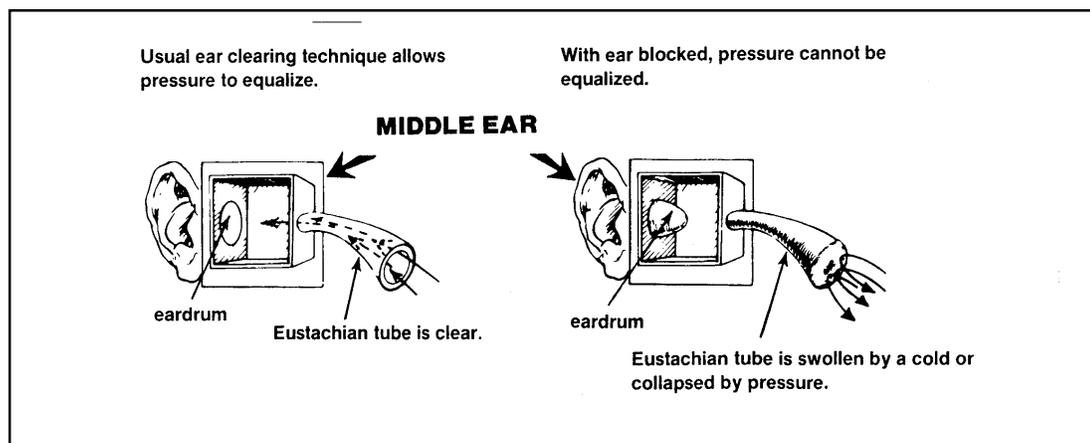

Figure 2-19. Pressure Effect on the Middle Ear During Descent

2-127. **After Flight.** Crew members who have breathed pure oxygen during an entire flight sometimes develop delayed ear block several hours after landing, although their ears were cleared adequately during descent. Delayed ear blocks are caused by saturation of the middle ear with oxygen. After crew members return to breathing ambient air, the tissue gradually reabsorbs the oxygen present in the middle ear. When a sufficient amount is absorbed, the pressure in the ear becomes less than that on the outside of the eardrum. Ear pain may awaken crew members after they have gone to sleep, or they may notice it when they awake the following morning. Usually this condition is mild and can be relieved by performing the Valsalva maneuver explained in paragraph 2-130 below.

### **Complications From Preexisting Physical Conditions**

2-128. **Respiratory Infections.** Crew members often complain of discomfort in the ears caused by inability to ventilate the middle ear adequately. Such inability occurs most frequently when the eustachian tube or its opening is swollen shut as the result of inflammation or infection coincidental with a head cold, sore throat, infection of the middle ear, sinusitis, or tonsillitis. In such cases, forceful opening of the tube may cause a disease-carrying infection to enter the middle ear along with the air. Therefore, crew members who have colds and sore throats should not fly. If flight is essential, slow descents will equalize pressure more easily.

2-129. **Temporal Bone and Jaw Problems.** Although upper respiratory infections are the main causes of narrowing of the eustachian tube, there are other causes. Crew members with malposition of the temporomandibular joint (temporal bone and jaw) may have ear pain and difficulty both in ventilating the middle ear and in hearing. In these cases, movement of the jaw (or yawning) relaxes surrounding soft tissues and clears the opening of the eustachian tube.

### **Prevention and Treatment**

2-130. **During Flight.** Normally, crew members can equalize pressure during descent by swallowing or yawning or by tensing the muscles of the throat. If these methods do not work, they can perform the Valsalva maneuver. To do this, they close the mouth, pinch the nose shut, and blow sharply. This maneuver forces air through the previously closed eustachian tube in the cavity of the middle ear; pressure will equalize. With repeated practice in rapidly clearing the ears, crew members can more easily tolerate increased rates of descent.

**Note:** To avoid overpressurization of the middle ear, crew members should never attempt a Valsalva maneuver during ascent.

2-131. **After Flight.** If middle-ear and ambient pressures have not equalized after landing and the condition persists, aviation personnel should consult a flight surgeon because barotitis media can occur. This is an acute or chronic traumatic inflammation of the middle ear caused by a difference of pressure on opposite sides of the eardrum. It is characterized by congestion, inflammation, discomfort, and pain in the middle ear and may be followed by temporarily or permanently impaired hearing, usually the former.

## TRAPPED-GAS DISORDERS OF THE SINUSES

2-132. Like the middle ear, sinuses can also trap gas during flight. The sinuses (Figure 2-20) are air-filled, relatively rigid, bony cavities lined with mucous membranes. They connect with the nose by means of one or more small openings. The two frontal sinuses are within the bones of the forehead; the two maxillary sinuses are within the cheekbones; and the two ethmoid sinuses are within the bones of the nose.

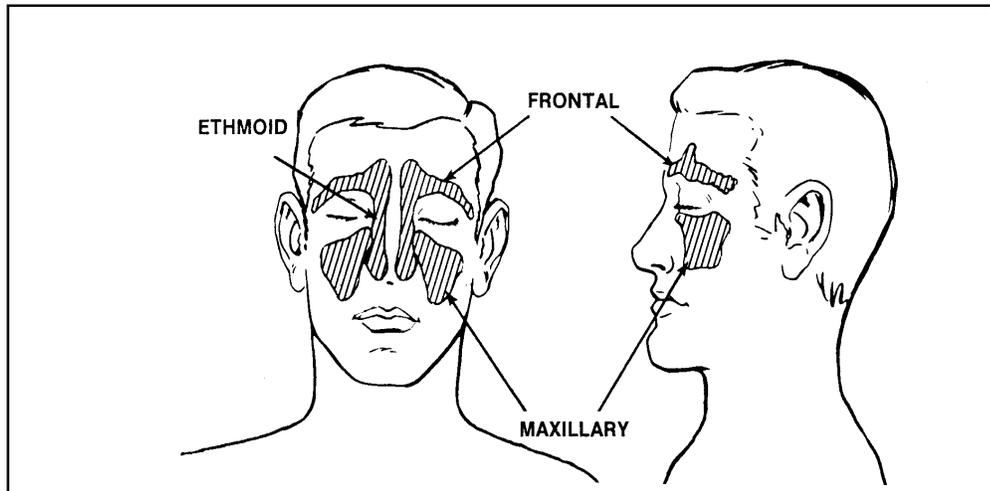

Figure 2-20. Sinus Cavities

### Cause

2-133. If the openings into the sinuses are normal, air passes into and out of these cavities without difficulty and pressure equalizes during ascent or descent. Swelling of the mucous membrane lining, caused by an infection or allergic condition, may obstruct the sinus openings. Viscous secretions that coat tissue may also cover the openings. These conditions may make it impossible to equalize the pressure. Change of altitude produces a pressure differential between the inside and the outside of the cavity, sometimes causing severe pain. Unlike the ears, ascent and descent almost equally affect the sinuses. If the frontal sinuses are involved, the pain extends over the forehead above the bridge of the nose. If the maxillary sinuses are affected, the pain is on either side of the nose in the region of the cheekbones. Maxillary sinusitis may produce pain in the teeth of the upper jaw; the pain may be mistaken for toothache.

### Prevention

2-134. As with middle-ear problems, sinus problems are usually preventable. Aircrew members should avoid flying when they have a cold or congestion. During descent, they can perform the Valsalva maneuver often. The opening to a sinus cavity is quite small, compared to the Eustachian tube; unless the pressure is equalized, extreme pain will result. If crew members notice any pain in a sinus on ascent, they should avoid any further increase in altitude.

## **Treatment**

2-135. If a sinus block occurs during descent, aircrews should avoid further descent. They should attempt a forceful Valsalva maneuver. If this maneuver does not clear the sinuses, they should ascend to a higher altitude. This ascent will ventilate the sinuses. They can also perform the normal Valsalva maneuver during slow descent to the ground. If the aircraft is equipped with pressure-breathing equipment, they can use oxygen, under positive pressure, to ventilate the sinuses. If the pressure does not equalize after landing, crew members should consult the flight surgeon.

## **TRAPPED-GAS DISORDERS OF THE TEETH**

2-136. Changes in barometric pressure cause toothache, or barodontalgia. This is a significant but correctable indisposition. The toothache usually results from an existing dental problem. The onset of toothache generally occurs from 5,000 to 15,000 feet. In a given individual, the altitude at which the pain occurs shows a remarkable constancy. The pain may or may not become more severe as altitude increases. Descent almost invariably brings relief; the toothache often disappears at the same altitude at which it first occurred.

## **EVOLVED-GAS DISORDERS**

2-137. Evolved-gas disorders occur in flight when atmospheric pressure is reduced as a result of an increase in altitude. Gases dissolved in body fluids at sea-level pressure are released from solution and enter the gaseous state as bubbles when ambient pressure is lowered (Henry's Law). This will cause varied skin and muscle symptoms, which are sometimes followed by neurological symptoms. Evolved-gas disorders are also known as decompression sickness.

## **HENRY'S LAW**

2-138. The amount of gas dissolved in a solution is directly proportional to the pressure of the gas over the solution. Henry's Law is similar to the example of gases being held under pressure in a soda bottle (Figure 2-21). When the cap is removed, the liquid inside is subject to a pressure less than that required to hold the gases in solution; therefore, gases escape in the form of bubbles. Nitrogen in the blood is affected by pressure changed in this same manner.

2-139. Inert gases in body tissues (principally nitrogen) are in equilibrium with the partial pressures of the same gases in the atmosphere. When barometric pressure decreases, the partial pressures of atmospheric gases decrease proportionally. This decrease in pressure leaves the tissues temporarily supersaturated. Responding to the supersaturation, the body attempts to establish a new equilibrium by transporting the excess gas volume in the venous blood to the lungs.

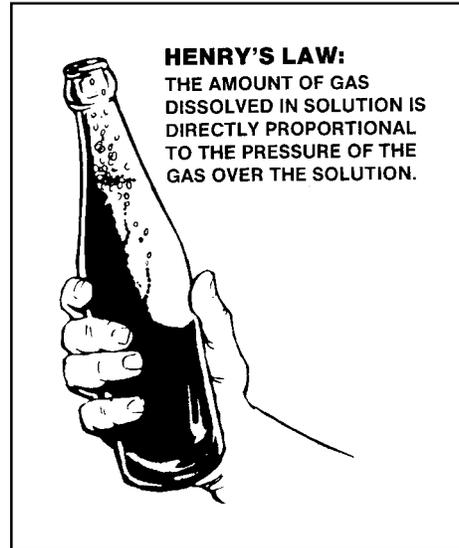

Figure 2-21. Henry's Law

## CAUSE

2-140. The cause of the various symptoms of decompression sickness is not fully understood. This sickness can be attributed to the nitrogen saturation of the body. This is related, in turn, to the inefficient removal and transport of the expanded nitrogen gas volume from the tissues to the lungs. Diffusion to the outside atmosphere would normally take place here.

2-141. Tissues and fluid of the body contain from 1 to 1.5 liters of dissolved nitrogen, depending on the pressure of nitrogen in the surrounding air. As altitude increases, the partial pressure of atmospheric nitrogen decreases and nitrogen leaves the body to reestablish equilibrium. If the change is rapid, recovery of equilibrium lags, leaving the body supersaturated. The excess nitrogen diffuses into the capillaries in solution and is carried by the venous blood for elimination. With rapid ascent to altitudes of 30,000 feet or more, nitrogen tends to form bubbles in the tissues and in the blood. In addition to nitrogen, the bubbles contain small quantities of carbon dioxide, oxygen, and water vapor. Additionally, fat dissolves five or six times more nitrogen than blood. Thus, tissues having the highest fat content are more likely to form bubbles.

## INFLUENTIAL FACTORS

2-142. Evolved-gas disorders do not happen to everyone who flies. The following factors tend to increase the chance of evolved-gas problems.

### Rate of Ascent, Level of Altitude, and Duration of Exposure

2-143. In general, the more rapid the ascent, the greater the chance that evolved-gas disorders will occur; the body does not have time to adapt to the pressure changes. At altitudes below 25,000 feet, symptoms are less likely to occur; above 25,000 feet, they are more likely to occur. The longer the exposure, especially above 20,000 feet, the more likely that evolved-gas disorders will occur.

### Age and Body Fat

2-144. An increase in the incidence of decompression sickness occurs with increasing age, with a three-fold increase in incidence between the 19- to 25-year old and the 40- to 45-year old age groups. The reason for this increase is not understood but may result from the changes in circulation caused by aging. No scientific validation exists to support any link between obesity and the incidence of decompression sickness.

### Physical Activity

2-145. Physical exertion during flight significantly lowers the altitude at which evolved-gas disorders occur. Exercise also shortens the amount of time that normally passes before symptoms occur.

### Frequency of Exposure

2-146. **Types of Evolved-Gas Disorders.** Frequency of exposure tends to increase the risk of evolved-gas disorders. The more often that individuals are exposed to altitudes above 18,000 feet (without pressurization), the more that they are predisposed to evolved-gas disorders.

2-147. **Bends.** At the onset of bends, pain in the joints and related tissues may be mild. The pain, however, can become deep, gnawing, penetrating, and eventually, intolerable. The pain tends to be progressive and becomes worse if ascent is continued. Severe pain can cause loss of muscular power of the extremity involved and, if allowed to continue, may result in bodily collapse. The pain sensation may diffuse from the joint over the entire area of the arm or leg. In some instances, it arises initially in muscle or bone rather than in a joint. The larger joints, such as the knee or shoulder, are most frequently affected. The hands, wrists, and ankles are also commonly involved. In successive exposures, pain tends to recur in the same location. It may also occur in several joints at the same time and worsens with movement and weight bearing. Coarse tremors of the fingers are often noted when the bends occur in joints of the arm.

2-148. **Chokes.** Symptoms occurring in the thorax are probably caused, in part, by innumerable small bubbles that block the smaller pulmonary vessels. At first, a burning sensation is noted under the sternum. As the condition progresses, the pain becomes stabbing and inhalation is markedly deeper. The sensation in the chest is similar to one that an individual experiences after completing a 100-yard dash. Short breaths are necessary to avoid distress. There is an almost uncontrollable desire to cough, but the cough is ineffective and nonproductive. Finally, there is a sensation of suffocation; breathing becomes more shallow, and the skin turns bluish. When symptoms of chokes occur, immediate descent is imperative. If allowed to progress, the condition leads to collapse and unconsciousness. Fatigue, weakness, and soreness in the chest may persist for several hours after the aircraft lands.

2-149. **Paresthesia.** Tingling, itching, cold, and warm sensations are believed to be caused by bubbles formed either locally or in the CNS where they involve nerve tracts leading to the affected areas in the skin. Cold and warm sensations of the eyes and eyelids, as well as occasional itching and gritty sensations, are sometimes noted. A mottled red rash may appear on the

skin. More rarely, a welt may appear, accompanied by a burning sensation. Bubbles may develop just under the skin, causing localized swelling. Where there is excess fat beneath the skin in the affected region, soreness accompanied by an abnormal accumulation of fluid may be present for one or two days.

2-150. **Central Nervous System Disorders.** In rare cases when aircrews are exposed to high altitude, symptoms may indicate that the brain or the spinal cord is affected by nitrogen-bubble formation. The most common symptoms are visual disturbances such as the perception of lights as flashing or flickering when they are actually steady. Other symptoms may be a dull-to-severe headache, partial paralysis, the inability to hear or speak, and the loss of orientation. Paresthesia or one-sided numbness and tingling may also occur. Hypoxia and hyperventilation may cause similar numbness and tingling; however, these are bilateral—they occur in both arms, legs, or sides. CNS disorders are considered a medical emergency; if they occur at high altitude, immediate descent and hospitalization are indicated.

## PREVENTION

2-151. In high-altitude flight and during hypobaric-chamber operations, aircrews can be protected against decompression sickness. Protective measures include—

- Denitrogenation.
- Cabin pressurization.
- Limitation of time at high altitude.
- Aircrew restrictions.

### Denitrogenation

2-152. Aircrews are required to breathe 100 percent oxygen for 30 minutes before takeoff for flights above 18,000 feet. Denitrogenation rids the body of excess nitrogen. This dumping of nitrogen from the body takes place because no nitrogen is coming in via the oxygen mask under 100 percent oxygen. The amount of nitrogen lost depends strictly on time. Within the first 30 minutes of denitrogenation (Figure 2-22), the body loses about 30 percent of its nitrogen.

### Cabin Pressurization

2-153. The pressurized aircraft cabin is usually maintained at a pressure equivalent to an altitude of 10,000 feet or below. This pressure lessens the possibility of nitrogen-bubble formation.

### Limitation of Time at High Altitude

2-154. The longer one stays at high altitude, the more nitrogen bubbles will form. Extended, unpressurized flight above 20,000 feet should be minimized.

### Aircrew Restrictions

2-155. AR 40-8 restricts crew members from flying for 24 hours after scuba diving. During scuba diving, excessive nitrogen uptake by the body occurs

while using compressed air. Flying at 8,000 feet within 24 hours after scuba diving at 30 feet subjects an individual to the same factors that a nondiver faces when flying unpressurized at 40,000 feet: nitrogen bubbles form.

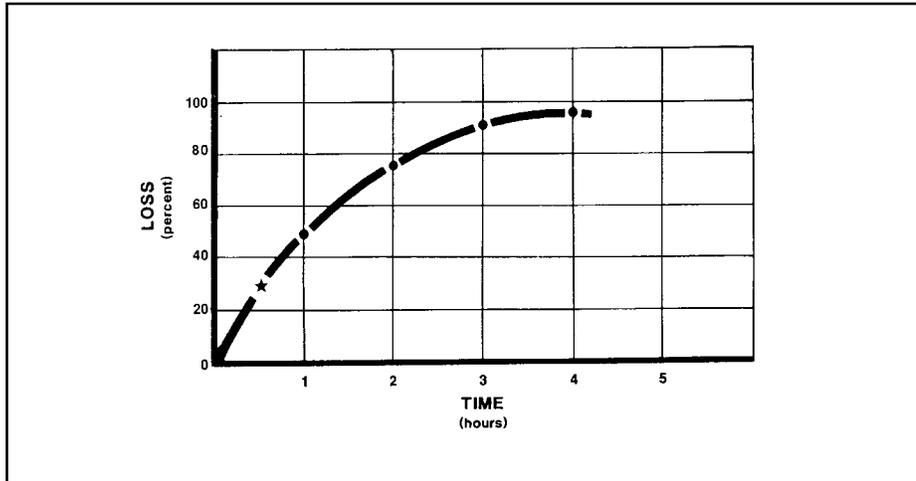

Figure 2-22. Nitrogen Elimination

#### TREATMENT

2-156. When symptoms and signs of evolved-gas disorders appear, aircrews should take the following corrective actions:

- Descend to ground level immediately.
- Place the affected individual on 100 percent oxygen to eliminate any additional nitrogen uptake and to remove excessive nitrogen from the system.
- Immobilize the affected area to prevent further movement of nitrogen bubbles in the circulatory system.
- Report to the flight surgeon or to the best medical assistance available.
- Undergo compression therapy in a hyperbaric chamber if symptoms persist and when prescribed by a flight surgeon.

#### DELAYED ONSET OF DECOMPRESSION SICKNESS

2-157. The onset of decompression sickness can occur as long as 48 hours after exposure to altitudes above 18,000 feet. This delayed onset may occur even if no signs/symptoms were evident during the flight.

## Chapter 3

# Stress and Fatigue in Flying Operations

Stress and fatigue in flight operations adversely affect mission execution and aviation safety. Consequently, aircrew members must be familiar with the effects of stress and fatigue on the body and how their behavior and lifestyles may reduce or, alternatively, increase the amount of stress and fatigue that they experience. This chapter reviews aviation stressors and their effects on aircrew-member performance, presents several strategies for coping with stress, and concludes with a discussion of fatigue and its prevention and treatment.

### STRESS DEFINED

3-1. Stress is the nonspecific response of the body to any demand placed upon it. About 1926, an Austrian physician, Hans Selye (an endocrinologist), identified what he believed was a consistent pattern of mind-body reactions that he called “the nonspecific response of the body to any demand.” He later referred to this pattern as the “rate of wear and tear on the body.” In search of a term that best described these concepts, he turned to the physical sciences and borrowed the term “stress.”

3-2. Selye’s definition is necessarily broad because the notion of stress involves a wide range of human experiences. However, it incorporates two very important basic points: stress is a *physiological* phenomenon involving actual changes in the body’s chemistry and function, and stress involves some perceived or actual demand for action. The definition does not qualify these demands as either positive or negative because both types of demands may be stressful. For example, although coming into the zone for promotion to a higher rank is generally considered a positive, potentially rewarding event, the ambiguity and uncertainty of the process are stressful.

### IDENTIFYING STRESSORS

3-3. A stressor is any stimulus or event that requires an individual to adjust or adapt in some way—emotionally, physiologically, or behaviorally. Stressors may be psychosocial, environmental, physiological, and cognitive. Before devising an effective stress-management plan, the individual needs to identify the significant stressors in his or her life. The remainder of this section reviews stressors that aircrew members typically encounter.

### PSYCHOSOCIAL STRESSORS

3-4. Psychosocial stressors are life events. These stressors may trigger adaptation or change in one’s lifestyle, career, and/or interaction with others.

### **Job Stress**

3-5. Work responsibilities can be a significant source of stress for aircrew members. Regardless of job assignment, carrying out assigned duties often produces stress. Conflict in the workplace, low morale and unit cohesion, boredom, fatigue, overtasking, and poorly defined responsibilities are all potentially debilitating job stressors.

3-6. Aircrew members who lack confidence in their ability or who have problems communicating and cooperating with others experience considerable stress.

3-7. Faulty aircraft maintenance also imposes stress on the aviator. Flight crews may not trust those who service their aircraft to perform proper maintenance. As a result, crew members may experience anxiety during flight operations that adversely affects the cohesion and morale of the aviation unit.

### **Illness**

3-8. Although the aviation population undergoes frequent and thorough medical examination, organic disease can occur and should be considered a source of stress. In addition, fatigue is a common symptom of many diseases.

### **Family Issues**

3-9. Although the family can be a source of emotional strength for crew members, it can also cause stress. Family commitments may adversely affect performance, particularly when duty assignments separate crew members from their families. The crew member's concern for family may become a distraction during flight operations or increase fatigue or irritability. The potential dangers of flight operations also act as a stressor on families and may cause tension in spousal relationships. This is particularly the case for the families of new, inexperienced personnel.

## **ENVIRONMENTAL STRESSORS**

### **Altitude**

3-10. The stress caused by altitude is most evident at altitudes below 5,000 feet. This is where the greatest atmospheric changes occur and aircrew members are subject to problems resulting from trapped gas. Even a common cold can cause ear and sinus problems during descent. Because flights seldom exceed an altitude of 18,000 feet, hypoxia and evolved-gas problems, such as the bends, are not significant sources of stress for most Army aviators. Chapter 2 covers the effects of evolved gas, trapped gas, and hypoxia in more detail.

### **Speed**

3-11. Flight is usually associated with speeds greater than those experienced in an everyday, earthbound environment. These speeds are stressful because they require a high degree of alertness and concentration over prolonged periods.

### **Hot or Cold Environments**

3-12. Extreme heat or cold causes stress in the aviation environment. Heat problems may be due to hot, tropic-like climates or to direct sunlight entering through large canopies. Cold problems, on the other hand, may be due to altitude or arctic climates. To lessen temperature stress, crew members need to gradually adapt to the extremes and use proper clothing and equipment.

### **Aircraft Design**

3-13. Human factors engineering items—such as cockpit illumination, instrument location, accessibility of switches and controls, and seat comfort—significantly affect aviator performance. Other influential human factors are the adequacy of heating and ventilating systems, visibility, and noise level. When such items are inadequate or uncomfortable, aircrew members will experience increased stress, which may divert their attention from performing operational duties.

### **Airframe Characteristics**

3-14. The handling and flight characteristics of the airframe are potential stress factors. For example, fixed-wing aircraft have innate stability so that, when trimmed, they can be flown relatively well with minimal pilot attention. Rotary-wing aircraft, however, require constant pilot attention to maintain stability.

### **Instrument Flight Conditions**

3-15. Poor weather resulting in instrument flight conditions imposes significant stress and increases the fatigue of aircrews. Awareness of a greater potential for physical danger and the need for increased vigilance and accuracy in reading, following, and monitoring flight instruments are very stressful. There is a high correlation between adverse weather and accident rates.

3-16. The stress of night flying is similar to the stress of flying in poor weather. Aviators lose their usual visual references and must rely on flight instruments.

### **PHYSIOLOGICAL (SELF-IMPOSED) STRESSORS**

3-17. Although aircrew members often have limited control over many aspects of aviation-related stress, they can exert significant control over self-imposed stress. Many aircrew members engage in maladaptive behaviors that are potentially debilitating and threaten aviation safety. This category can be remembered using the acronym DEATH, which stands for drugs, exhaustion, alcohol, tobacco, and hypoglycemia (Figure 3-1).

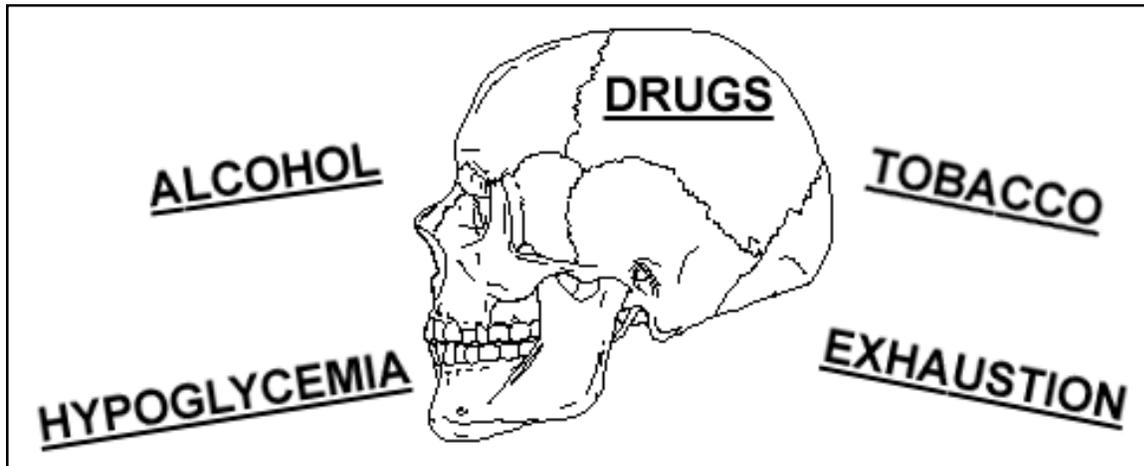

Figure 3-1. DEATH

## Drugs

3-18. **Self Medication.** Commercial advertising continually encourages the purchase of nonprescription, over-the-counter medications for a range of minor ailments. The primary purpose of such medications is to *cure a medical problem* or control symptoms of the problem. According to Army regulation, aircrew members must keep the flight surgeon informed of any significant changes in their physical health. Furthermore, most drugs, whether prescribed or over the counter, have unwanted side effects that may vary from person to person. In general, no aircrew member taking medication is fit to fly unless a flight surgeon has specifically cleared the crew member to fly.

3-19. **Predictable Side Effects.** These effects accompany the use of a drug and are incidental to its desired effect. Table 3-1 includes examples of common over-the-counter drugs and their known side effects. These side effects highlight the need for crew members to be aware of known potential problems with drugs. Although crew members may not experience all of the listed side effects, they should know that these might occur.

3-20. **Overdose Problems.** Drugs are to be taken in a given amount over a specified time. The reasoning that “if one pill is good for me, two will be even better” is invalid.

3-21. **Allergic Reactions and Idiosyncrasies.** Some individuals may experience an exaggerated or pathological reaction to a medicine. An example is an allergic reaction to penicillin.

3-22. **Synergistic Effects.** This term refers to undesired effects resulting from the combination of two or more drugs or from a stressful situation experienced while taking a prescribed drug.

Table 3-1. Possible Side Effects of Commonly Used Drugs

Substance	Generic Or Brand Name	Treatment For	Possible Side Effects
<b>Alcohol</b>	Beer Liquor Wine		Impaired judgment and perception Impaired coordination and motor control Reduced reaction time Impaired sensory perception Reduced intellectual functions Reduced tolerance to G-forces Inner-ear disturbance and spatial disorientation (up to 48 hours) Central nervous system depression
<b>Nicotine</b>	Cigars Cigarettes Pipe tobacco Chewing tobacco Snuff		Sinus and respiratory system infection and irritation Impaired night vision Hypertension Carbon monoxide poisoning (from smoking)
<b>Amphetamines</b>	Ritalin Obetrol Eskatrol	Obesity (diet pills) Tiredness	Prolonged wakefulness Nervousness Impaired vision Suppressed appetite Shakiness Excessive sweating Rapid heart rate Sleep disturbance Seriously impaired judgment
<b>Caffeine</b>	Coffee Tea Chocolate No-Doz		Impaired judgment Reduced reaction time Sleep disturbance Increased motor activity and tremors Hypertension Irregular heart rate Rapid heart rate Body dehydration (through increased urine output) Headaches
<b>Antacid</b>	Alka-2 Di-Gel Maalox	Stomach acids	Liberation of carbon dioxide at altitude (distension may cause acute abdominal pain and may mask other medical problems)
<b>Antihistamines</b>	Coricidin Contac Dristan Dimetapp Ornade Chlor-Trimeton	Allergies Colds	Drowsiness and dizziness (sometimes recurring) Visual disturbances (when medications also contain antispasmodic drugs)
<b>Aspirin</b>	Bayer Bufferin Alka-Seltzer	Headaches Fevers Aches Pains	Irregular body temperature Variation in rate and depth of respiration Hypoxia and hyperventilation (two aspirin can contribute to) Nausea, ringing in ears, deafness, diarrhea, and hallucinations when taken in excessive dosages Corrosive action on the stomach lining Gastrointestinal problems Decreased clotting ability of the blood (clotting ability could be the difference between life and death in a survival situation)

**Caffeine**

3-23. Caffeine is commonly ingested by many people. However, it is a drug with potentially negative effects on flight operations if not used properly and in moderation. Many beverages and foods—such as tea, chocolate, and most cola-type drinks—contain caffeine. Table 3-2 shows the varying amounts of caffeine in these products.

**Table 3-2. Caffeine Content of Common Beverages, Foods, and Over-the-Counter Drugs**

Product	Amount	Caffeine Content (mg)
<b>Coffee</b>		
Drip	5 oz	146
Perked	5 oz	110
Instant	5 oz	66
Decaffeinated	5 oz	3
<b>Tea</b>		
Five-minute brew	5 oz	46
One-minute brew	5 oz	28
<b>Cola-Type and Pepper-Type Drinks</b>		
Coca-Cola	12 oz	65
Dr. Pepper	12 oz	61
Tab	12 oz	50
Pepsi-Cola	12 oz	43
RC Cola	12 oz	38
<b>Chocolate and Cocoa</b>		
Sweet chocolate bar	1 oz	25
Cocoa	5 oz	13
<b>Over-the-Counter Drugs</b>		
No Doz	1 tablet	200
Dexatrim	1 tablet	200
Excedrin	1 tablet	130
Midol	1 tablet	65
Anacin	1 tablet	64
Dristan	1 tablet	32

3-24. Caffeine is a central nervous system stimulant that counteracts and delays drowsiness and fatigue. Although it increases alertness, the side effects of caffeine may degrade an aircrew member's performance. Caffeine can elevate blood pressure, impair hand-eye coordination and timing, and cause nervousness or irritability. Some people may experience adverse effects when ingesting only 150 to 200 milligrams of caffeine (the equivalent of one or two cups of coffee or several cups of tea). Caffeine is also addictive, and continued use builds tolerance. Over time, people must ingest increasing amounts of caffeine to obtain the same physiological and behavioral effects.

## Exhaustion

3-25. **Lack of Rest and Sleep.** Aircrew members require adequate rest and sleep to ensure optimal flight performance. Sleep problems are especially likely during deployments, when the sleep environment may be hot, cold, or noisy. Changes of time zones can also affect sleeping patterns. Crew members should discuss sleeping difficulties with the flight surgeon; inadequate sleep is a potential flight-safety hazard. Changing the work routine or improving the environment may promote sleep and increase operational efficiency.

3-26. **Physical conditioning.** Exercise stimulates the various body systems and has well-documented positive effects on mental health. Lack of exercise impairs circulatory efficiency, reduces endurance, and increases the likelihood of illness. General toning of the muscles, heart, and lungs is essential in preparing aircrews for field exercises and survival situations. Sports that require agility, balance, and endurance are an excellent means of keeping the body and mind in top form.

## Alcohol

3-27. Moderate ingestion of alcohol in the form of liquor, wine, or beer is a commonly accepted practice that usually causes no problems. In the aviation environment, however, alcohol can be deadly.

3-28. Ethyl alcohol acts as a depressant and adversely affects normal body functions. Even a small amount has a detrimental effect on judgment, perception, reaction time, impulse control, and coordination.

3-29. Alcohol reduces the ability of the brain cells to use oxygen. Each ounce of alcohol consumed increases the physiological altitude.

3-30. The affects of alcohol on the body and brain depend on three factors:

- The amount of alcohol consumed.
- The rate of absorption from the stomach and small intestine.
- The body's rate of metabolism (which is relatively constant at about 1 ounce every three hours).

3-31. After drinking alcohol, an aviator should wait at least 12 hours before beginning flying duties. Side effects of alcohol are dangerous. If side effects (hangover symptoms) are present, the nonflying period should be extended beyond 12 hours. Taking cold showers, drinking coffee, or breathing 100 percent oxygen does not speed up the body's metabolism of alcohol. Only time will dissipate the effects of alcohol.

3-32. Aircrew members should recognize alcohol as a potential safety hazard and assess their own risk for developing a problem with alcohol. This assessment involves examining the frequency and amount of one's consumption as well as the reasons for consumption. Alcohol should not be a stress-coping strategy.

3-33. Some individuals are more likely to develop an alcohol-abuse problem than are others. For example, people with a family history of alcoholism are at greater risk for developing an alcohol problem than are those without such a history.

3-34. The following four questions will help aircrew members determine if they are misusing or have misused alcohol:

- Have you ever tried to cut back on your alcohol consumption?
- Are you annoyed by comments that people make about your drinking?
- Have you ever felt guilty about your drinking?
- Have you ever had a drink first thing in the morning to get you started?

3-35. Answering “yes” to two or more of these questions may indicate inappropriate alcohol use. Crew members should then more closely examine how frequently, how much, and why they drink alcohol.

### **Tobacco**

3-36. The detrimental effects of tobacco on health are well known. Apart from the long-term association with lung cancer and coronary heart disease, there are other important, but less dramatic, effects. For example, chronic irritation of the lining of the nose and lungs caused by tobacco increases the likelihood of infection in these areas. This is a significant problem for aviators because it affects their ability to cope with the effects of pressure changes in the ears and sinuses. In addition, even a mildly irritating cough causes distress when oxygen equipment is used.

3-37. Although smoking has many long-term effects, such as emphysema and lung cancer, the aviator should be just as concerned about the acute effect of carbon monoxide produced by smoking tobacco. Carbon monoxide combines with hemoglobin to form carboxyhemoglobin. Carbon monoxide attaches to hemoglobin molecules 200 to 300 times more readily than does oxygen. The net effect is a degree of hypoxia. Average cigarette smokers have about 8 to 10 percent CoHb in their blood. This percentage adds about 5,000 feet of physiological altitude. Cigarette smoking also decreases night vision. A nonsmoking pilot begins to experience decreased night vision at 4,000 to 5,000 feet of altitude because of hypoxia; but a smoking pilot begins at sea level with a physiological night-vision deficit of 5,000 feet.

### **Hypoglycemia**

3-38. Aviation medicine experts recognize the importance of a nutritious, well-balanced diet for aircrew members. Nutrition largely depends on individual behavior. When possible, crew members should consume meals at regular intervals. Missing meals or substituting a quick snack and coffee for a balanced meal can induce fatigue and inefficiency. The body requires periodic refueling to function. Normal, regular eating habits are important. Because of mission requirements, aircrew members often disrupt their regular eating habits and skip meals. This disruption can lead to hypoglycemia.

3-39. The liver has a store of energy. This energy is stored in the form of glycogen, a blood sugar. The liver can readily convert this stored form of sugar into glucose that is released to the body to maintain the body's blood-sugar level. Unless food is consumed at regular intervals, the stored glycogen is depleted and a low blood-sugar level, or hypoglycemia, develops.

When the blood-sugar level falls, weakness or fainting occurs and the body's efficiency decreases.

3-40. Insulin lowers the blood-sugar level, but at the same time, blood-sugar is also decreasing through its normal function of fueling the body. These two actions result in a rapid drop in blood sugar that causes further tiredness and inefficiency. It is important to maintain a balanced diet of proper foods that includes proteins, fats, and carbohydrates.

3-41. Aviators must also guard against obesity because of its detrimental effects on general health and performance. Inactivity and boredom during standby duty and long flights can easily lead to overeating. Therefore, it is wise to weigh oneself regularly and adjust the diet to maintain desired weight. This is easier and safer than repeated dieting. In addition, crew members should consult a flight surgeon before beginning a weight-loss dieting regimen. Diet pills are not authorized while on flight status.

### **COGNITIVE STRESSORS**

3-42. How one perceives a given situation or problem is a potentially significant and frequently overlooked source of stress. Pessimism, obsession, failure to focus on the present, and/or low self-confidence can create a self-fulfilling prophecy that will ensure a negative outcome. Below are some typical problems that crew members may encounter in thinking that can increase overall stress.

#### **“Musts and Shoulds”**

3-43. Albert Ellis, a renowned clinical psychologist, observed that stress results when individuals believe that things *must* go their way or *should* conform to their own needs and desires or they cannot function. This lack of flexibility in thinking causes problems when reality does not accommodate one's wishes. Failure to accept the possibility that things may happen contrary to one's wishes leaves one unprepared, frustrated, and dysfunctional.

#### **Choice or No Choice**

3-44. Healthy individuals believe that there are choices in life. Although certain consequences may make some choices unpalatable, they are choices nonetheless. Experiencing oneself as actively making choices increases one's sense of personal control and decreases stress. Unhappy, unhealthy, and overly stressed individuals often fail to see that they have choices. These people see the world as the cause of their problems.

#### **Failure to Focus on the Here and Now**

3-45. Living in the past or the future and overemphasizing what should have been or what could be can increase one's overall stress. Although there is utility in both learning from the past and planning for the future, overengaging in either of these activities can cause people to fail at tasks and miss opportunities in the present.

## **THE STRESS RESPONSE**

3-46. Stress affects individuals in a variety of ways. These effects may include emotional, behavioral, cognitive (thoughts), and physical responses.

### **EMOTIONAL RESPONSES**

3-47. Emotional responses to stress may range from increased anxiety, irritability, or hostility to depressed mood, loss of self-esteem, hopelessness, and an inability to enjoy life. If emotional responses are severe and interfere significantly with social or occupational functioning, crew members should consult the flight surgeon. Aviators and other aviation personnel often shy away from seeking help for emotional problems, but it is important to recognize that stress can become overwhelming at times and present a serious threat to aviation safety.

### **BEHAVIORAL RESPONSES**

3-48. High stress can adversely affect one's work performance, decrease motivation, and increase the likelihood of conflict, insubordination, and violence in the workplace. Some individuals may become socially isolated. Others may abuse drugs or alcohol as an ineffective stress-coping strategy. Suicidal thoughts and intent may also occur in individuals under high stress. The following are danger signals for suicide risk:

- Talking or hinting about suicide.
- Having a specific plan to commit suicide and the means to accomplish it.
- Obsession with death.
- Giving away possessions or making a will.
- A history of prior suicide attempts.
- Multiple, recent life stressors.
- Alcohol consumption, which increases the risk of following through on suicidal thoughts.

3-49. Crew members should always take these danger signals seriously. Individuals exhibiting some or all of these signals should be approached supportively and referred to a mental-health provider for evaluation. The flight surgeon should be contacted to make an appropriate referral to a mental-health provider.

### **COGNITIVE RESPONSES**

3-50. Stress can significantly affect one's thought processes. It can decrease attention and concentration, interfere with judgment and problem solving, and impair memory. Stress can cause aviators to commit thinking errors and to take mental shortcuts that could be potentially fatal.

#### **The Simplification Heuristic**

3-51. Under high-stress conditions, people tend to oversimplify problem solving and ignore important relevant information, taking the easy way out.

For example, an aviator experiencing high stress before going into combat may, in haste, fail to follow all of the steps of the preflight inspection.

### **Stress-Related Regression**

3-52. Many individuals under high-stress conditions will forget learned procedures and skills and revert to bad habits. For example, a student aviator preparing for takeoff may forget to turn on the fuel switch and then, realizing the problem and feeling stressed and embarrassed, turn the switch on and risk overheating the engine. This action is clearly contrary to his training and represents a kind of regression or failure to use prior learning.

### **Perceptual Tunneling**

3-53. This is a phenomenon in which an individual or an entire crew under high stress becomes focused on one stimulus, like a flashing warning signal, and neglects to attend to other important tasks/information such as flying the aircraft. A similar situation may occur when an aviator realizes during flight that he or she overlooked some aspect of flight such as missing a radio communication. The stressed aviator may then overattend to rectifying this problem/become emotionally and mentally fixated on the error and fall "behind the aircraft," missing new information and further compromising the mission.

## **PHYSICAL RESPONSES**

3-54. The immediate physical response to a stressful situation involves overall heightened arousal of the body. The response may include increased heart rate, increased blood pressure, more rapid breathing, tensing of the muscles, and the release of sugars and fats into circulation to provide fuel for "fight or flight."

3-55. Prolonged stress and its continuous effects on the body may produce longer-term physical symptoms such as muscle tension and pain, headaches, high blood pressure, gastrointestinal problems, and decreased immunity to infectious diseases.

## **STRESS UNDERLOAD**

3-56. Having too little stress in one's life may be as dysfunctional as having too much stress. A lack of challenges can lead to complacency, boredom, and impulsive risk taking. Individuals should strive to balance the stress in their lives to be optimally challenged without overwhelming their coping resources. The effects of stress underload are of particular concern in peacekeeping operations. In such operations, soldiers will often have a considerable amount of unstructured time and work tasks can become routine and monotonous. Thus, leaders need to minimize unstructured time as much as possible, using it, instead, as an opportunity for skills training, cross-training, and physical training and other activities that challenge and develop subordinates.

## **STRESS AND PERFORMANCE**

3-57. The relationship between stress and performance depends on a variety of factors. These factors will be discussed in the following paragraphs.

### **MENTAL SKILLS REQUIRED BY THE TASK OR SITUATION**

3-58. The degree to which a given task or situation requires specific cognitive skills—such as attention, concentration, memory, problem solving, or visual-spatial orientation—will influence the extent to which stress will degrade performance. Performance in situations involving simple mental tasks tends to be less affected by stress than performance in situations that require more complex cognitive skills. For example, writing a letter under high stress would probably result in fewer errors than taking a written exam under high stress.

### **STRESS CHARACTERISTICS OF THE SITUATION**

3-59. The degree to which stress affects performance also depends on the environment and conditions under which a given task is performed. For example, taking a stressful, timed problem-solving test in a quiet, comfortable room is much easier and will result in fewer errors than taking the same test in a hot, noisy room.

### **PHYSICAL CHARACTERISTICS OF THE INDIVIDUAL**

3-60. Individual differences in strength, endurance, and physical health greatly influence the extent to which stress affects performance. This is especially true in aviation operations in which aircrew members must be in top physical condition to perform in the physically challenging conditions of continuous operations and combat.

### **PSYCHOLOGICAL MAKEUP OF THE INDIVIDUAL**

3-61. Mental health, much like physical health, serves to moderate the effects of stress on performance. Individuals with good coping, problem-solving, and social skills will perform much better under stress than those who are weaker in these areas.

### **STRESS MANAGEMENT**

3-62. Stress-coping mechanisms are psychological and behavioral strategies for managing the external and internal demands imposed by stressors. Coping mechanisms can be characterized according to the following categories.

### **AVOIDING STRESSORS**

3-63. This is the most powerful coping mechanism. Crew members can avoid stressors with good planning, foresight, realistic training, good time management, and effective problem solving. Staying physically fit and eating right are also effective strategies for avoiding fatigue, illness, and related stressors. Good crew coordination and communication—including asking questions, using three-way confirm responses, and briefing lost communication—also serve to avoid flight stress.

## CHANGING YOUR THINKING

3-64. As indicated in the earlier discussion on cognitive stressors, how you perceive your environment and choose to think about yourself and others greatly affect your stress level and performance. Crew members may greatly enhance their stress management and personal effectiveness by—

- Practicing positive self-talk.
- Taking responsibility for their actions.
- Recognizing the choices that they make.
- Avoiding perfectionism and inflexibility in thinking.
- Focusing on the here and now rather than on the past or future.

## LEARNING TO RELAX

3-65. Relaxation is incompatible with stress. It is impossible to be relaxed and anxious at the same time. Learning and regularly practicing relaxation techniques, breathing exercises, or meditation or regularly engaging in a quiet hobby greatly reduce stress. Although this recommendation may sound simplistic, few people actually practice relaxation regularly. Making time to relax during a busy schedule is perhaps the biggest obstacle to this coping strategy.

## VENTILATING STRESS

3-66. This strategy involves “blowing off steam” in some manner, either through talking or vigorous exercise. Talking out problems may be accomplished informally, with friends or family, or professionally, with a mental-health practitioner or chaplain. Exercise should be a regular part of everyone’s lifestyle; it is effective in both preventing and coping with stress problems. Volumes of research have documented the positive benefits of exercise for both physical and mental health.

## FATIGUE

3-67. Fatigue is the state of feeling tired, weary, or sleepy that results from prolonged mental or physical work, extended periods of anxiety, exposure to harsh environments, or loss of sleep. Boring or monotonous tasks may increase fatigue.

3-68. As with many other physiological problems, crew members may not be aware of fatigue until they make serious errors. Sleep deprivation, disrupted diurnal cycles, or life-event stress may all produce fatigue and concurrent performance decrements. The types of fatigue are acute, chronic, and motivational exhaustion, or burnout.

## ACUTE FATIGUE

3-69. Acute fatigue is associated with physical or mental activity between two regular sleep periods. The loss of both coordination and awareness of errors is the first type of fatigue to develop. Crew members feel this tiredness, for example, at night after being awake for 12 to 15 hours in a day. With

adequate rest or sleep, typically after one regular sleep period, the aircrew member will overcome this fatigue. Acute fatigue is characterized by—

- Inattention.
- Distractibility.
- Errors in timing.
- Neglect of secondary tasks.
- Loss of accuracy and control.
- Lack of awareness of error accumulation.
- Irritability.

Mental deficits like those listed above are apparent to others before the individual notices any physical signs of fatigue.

### **CHRONIC FATIGUE**

3-70. This much more serious type of fatigue occurs over a longer period and is typically the result of inadequate recovery from successive periods of acute fatigue. Besides physical tiredness, mental tiredness also develops. It may take several weeks of rest to completely eliminate chronic fatigue; and there may be underlying social causes, such as family or financial difficulties, that must be addressed before any amount of rest will help the person recover. The crew member or unit commander must identify chronic fatigue early and initiate a referral to the flight surgeon for evaluation and treatment. Chronic fatigue is characterized by some or all of the following characteristics:

- Insomnia.
- Depressed mood.
- Irritability.
- Weight loss.
- Poor judgment.
- Loss of appetite.
- Slowed reaction time.
- Poor motivation and performance on the job.

### **MOTIVATIONAL EXHAUSTION OR BURNOUT**

3-71. If chronic fatigue proceeds untreated for too long, the individual will eventually “shut down” and cease functioning occupationally and socially. Motivational exhaustion is also known as burnout.

## **EFFECTS OF FATIGUE ON PERFORMANCE**

### **REACTION-TIME CHANGES**

3-72. Fatigue can result in either increases or decreases in reaction time. Increases occur because of the general decrease in motivation and sluggishness that often accompany fatigue. Decreases in reaction time may also occur, however, when individuals become impulsive and react quickly and poorly.

### **REDUCED ATTENTION**

3-73. Aircrew members may exhibit the following signs/symptoms of reduced attention:

- Tendency to overlook or misplace sequential task elements (for example, forgetting items on preflight checklists).
- Preoccupation with single tasks or elements—for example, paying too much attention to a bird and forgetting to fly the aircraft (the cause of many accidents).
- Reduction of audiovisual scan both inside and outside of the cockpit.
- Lack of awareness of poor performance.

### **DIMINISHED MEMORY**

3-74. Aircrew members may be experiencing diminished memory when they display the following characteristics:

- Short-term memory and processing capacity decrease although long-term memory tends to be well preserved during fatigue. Integrating new information and making decisions becomes more challenging, as does adaptability to change in general.
- Inaccurate recall of operational events (for example, forgetting the location of the objective rally point).
- Neglect of peripheral tasks (for example, forgetting to check if the landing gear is down).
- Tendency to revert to old bad habits.
- Decreased ability to integrate new information and analyze and solve problems.

### **CHANGES IN MOOD AND SOCIAL INTERACTION**

3-75. Fatigued individuals may become irritable and combative. They may also experience mild depression and withdraw socially.

### **IMPAIRED COMMUNICATION**

3-76. Fatigue impairs one's ability to both communicate and receive information. Individuals may leave out important details in the messages that they send to others. They may also fail to attend completely to information that they receive, or they may misinterpret the information. Fatigue can also affect a crew member's pronunciation, rate of speech, tone, or volume.

### **DIURNAL (CIRCADIAN) RHYTHMS AND FATIGUE**

3-77. We have an intrinsic biological clock with a cycle of roughly 24 to 25 hours, and many important bodily functions such as core body temperature, alertness, heart rate, and sleep cycle occur along these diurnal rhythms. In the typical circadian cycle, performance, alertness, and body temperature—

- Peak between 0800 and 1200 hours.
- Drop off slightly between 1300 and 1500.

- Begin to increase again from 1500 to 2100.
- Drop off again and fall to a minimum circadian trough between 0300 and 0600 hours.

3-78. While the body clock can monitor the passage of time, it differs from most clocks in that it is flexible and must be set, or synchronized, before it can accurately predict the timing of events. External synchronizers or Zeitgebers (a German word that means “time givers”) are—

- Sunrise/sunset.
- Ambient temperature.
- Meals/social cues.

### **CIRCADIAN DESYNCHRONIZATION (JET LAG)**

3-79. Rapid travel from one time zone to another causes the body to resynchronize its diurnal rhythms to the local geophysical and social time cues. Until intrinsic rhythms are reset, sleep disorders and fatigue will prevail. Traveling eastward shortens the day; westward travel lengthens the day. Consequently, resynchronization occurs much more rapidly when traveling west. Shift work can have effects similar to crossing time zones because of the changes in light exposure and activity times.

### **THE SLEEP CYCLE**

3-80. Sleep is not simply being unconscious. It is a life-essential active process. The sleeping brain cycles between rapid eye movement and non-REM sleep through five stages. The cycling occurs every 90 minutes. In eight hours of sleep, one normally attains five to six REM stages.

3-81. The duration and quality of sleep depend on body temperature. People sleep longer and report a better night’s sleep when they retire near the temperature trough.

3-82. As indicated above in the section on diurnal rhythms, it is the timing of sleep, not necessarily the amount of sleep, that is most significant. A sleep schedule that is inconsistent with one’s circadian rhythm and the light and social cues of the environment will ultimately result in fatigue. Frequent changes in one’s sleep schedule may also result in fatigue.

3-83. Sleep efficiency deteriorates with age. Older individuals spend less time in deep non-REM sleep. Nighttime awakenings and daytime sleepiness result.

### **SLEEP REQUIREMENTS**

3-84. Individuals cannot accurately determine their own impairment from sleep loss. During operations in which sleep loss is expected, aircrew members should closely monitor each other’s behavior for indicators of fatigue such as those identified in paragraphs 3-73 through 3-77.

3-85. The average person sleeps seven to nine hours per day. Sleep length can be reduced one to two hours without performance decrement over an

extended period. Once the period ends, however, individuals must return to their normal sleep length.

3-86. As a rule, five hours of sleep per night are the minimum for continuous operations (for example, for 14 days). However, some individuals may tolerate as little as four hours per night for short periods (up to one week).

3-87. Sleep-restriction decisions and crew-endurance planning should consider—

- Complexity of the job tasks to be performed under conditions of fatigue.
- Potential for loss from errors committed because of fatigue.
- The individual's tolerance of sleep loss.

## **PREVENTION OF FATIGUE**

3-88. Total prevention of fatigue is impossible, but its effects can be significantly moderated. The following recommendations should be considered in any individual- or crew-endurance plan.

## **CONTROL THE SLEEP ENVIRONMENT**

3-89. The sleep environment should be cool, dark, and quiet. It is also best to avoid working or reading in bed; this may actually contribute to problems in falling asleep. The bed should be associated only with sleeping and sexual activity. If you desire to read before going to bed, do this in a chair, preferably in a room other than your bedroom, and then go to bed.

## **ADJUST TO SHIFT WORK**

3-90. The following measures will help aircrew members adjust to shift work and prevent circadian desynchronization:

- Maintain a consistent sleep-wake schedule even on days off.
- When on the night shift, avoid exposure to daylight from dawn to 1000. Wear sunglasses if you cannot go to sleep before the sun rises (as long as this does not pose a safety hazard). Consider wearing a sleep mask while sleeping to avoid any exposure to light.
- You may eat a light snack before going to sleep. Do not go to sleep too full or too hungry.
- Avoid caffeine consumption for six hours before going to sleep.

## **MAINTAIN GOOD HEALTH AND PHYSICAL FITNESS**

3-91. Aircrew members can maintain good physical fitness with regular strenuous exercise. Elimination of tobacco use also promotes good health and physical fitness.

## **PRACTICE GOOD EATING HABITS**

3-92. It is important to maintain a balanced diet of proper foods that includes proteins, fats, and carbohydrates. Failing to give the body the quality fuel that it needs will contribute to the aircrew member's fatigue and poor work performance.

### **PRACTICE MODERATE, CONTROLLED USE OF ALCOHOL AND CAFFEINE**

3-93. Use of alcohol as a sleep aid can interfere with REM sleep and disrupt sleep patterns. Frequent use of caffeine often contributes to insomnia.

### **PLAN AND PRACTICE GOOD TIME MANAGEMENT**

3-94. Plan and practice good time management to avoid last-minute crises. A reasonable, realistic work schedule will assist greatly in preventing fatigue.

### **PRACTICE REALISTIC PLANNING**

3-95. Practice realistic planning for total duty and flying hours as outlined in AR 95-1. Studies have shown that the relative fatigue factor of a flight hour varies with the type of flight environment that the aviator encounters (for example, chemical MOPP flight is more fatiguing than day NOE flight).

### **MAINTAIN OPTIMAL WORKING CONDITIONS**

3-96. Particular attention should be devoted to addressing problems associated with the following factors:

- Glare.
- Vibration.
- Noise levels.
- Poor ventilation.
- Temperature extremes.
- Uncomfortable seating.
- Inadequate oxygen supply.
- Instrument and control location.
- Anthropometry (body measurements).

### **TAKE NAPS**

3-97. When sleep is not available or is shortened by operational concerns, naps are a viable alternative. In general, longer naps are more beneficial than short naps, but even naps as short as 10 minutes can increase one's energy level. Longer naps (greater than one hour) may result in a period of sluggishness (sleep inertia) for 5 to 20 minutes after awakening. Therefore, longer naps are better than shorter naps. Therefore, when deciding how long to nap, one should consider what work requirements would be present upon awakening from the nap. The best time to nap is when body temperature is low (around 0300 and 1300).

**Note:** If you are having problems sleeping during your normal sleep period, *do not* take naps during the rest of the day because napping may delay sleep onset during your regular sleep period.

### **TREATMENT OF FATIGUE**

3-98. The most important action for treating fatigue is to get rest and *natural* (not drug-induced) sleep. Alcohol is the number-one sleep aid in the United

States, but it suppresses REM sleep, as mentioned above. Correcting bad sleep habits is one type of treatment for fatigue.

3-100. If you find yourself lying awake in bed for more than 30 minutes, get out of bed and read a boring book or listen to some relaxing music until you are ready to fall asleep. Lying in bed awake can produce a mental association between being in bed and anxiety/wakefulness, which will promote insomnia. If you return to bed and remain awake for more than 30 minutes, get up again. Continue to do this as much as needed during the night. Eventually, fatigue will take over and you will sleep.

3-101. When attempting to recover from 24 to 48 hours of sleep deprivation, do not sleep longer than 10 hours. Sleeping for too long may further disrupt the sleep-wake schedule and cause sluggishness during the day.

3-102. There are other measures that can be taken to prevent or treat fatigue:

- Modify the workplace to promote rest and prevent any further fatigue.
- Rotate duties to avoid boredom, or change duties.
- Pace yourself, and avoid heavily task-loaded activities, those requiring short-term memory, or those demanding prolonged or intense mental activity.
- Limit work periods, and delegate responsibility. If possible, suspend activity during periods when fatigue is higher and efficiency is lower; for example, between 1300 and 1500 hours.
- Use brief periods of physical exercise immediately before task performance, particularly administrative work. However, do not exercise closer than one hour before bedtime; exercising may delay the onset of sleep.
- Remove yourself from flying duties when fatigue affects flight safety.

## Chapter 4

# Gravitational Forces

Army aircrew members must understand gravitational forces and the physiological responses of the body to them in the aviation environment. This is especially true with the advent of the newer high-performance helicopters such as the UH-60 Black Hawk and the AH-64 Apache. This chapter discusses the physics of motion and acceleration, and covers the types and directions of accelerative forces and their influences and effects. It also discusses deceleration and, more importantly, the crash sequence and how aircraft design offers protection from crash forces. Aircrew members must have a fundamental, but thorough, understanding of the accelerative forces encountered during flight and their relationship to the human body.

### TERMS OF ACCELERATION

4-1. Several terms are used in discussing acceleration. Those most commonly used are speed, velocity, inertial force, centrifugal force, and centripetal force. These terms are defined in the glossary.

### TYPES OF ACCELERATION

4-2. Flight imposes its greatest effects on the body through the accelerative forces applied during aerial maneuvering. In constant speed and straight-and-level flight, aircrew members encounter no human limitations. With changes in velocity, however, they can experience severe physiological effects. Acceleration is the rate of change in velocity and is measured in Gs. The aviator needs to understand where and how accelerative forces—linear, radial or centripetal, and angular—develop in flight.

### LINEAR ACCELERATION

4-3. This type of acceleration is a change in speed without a change in direction. It occurs during takeoffs and changes in forward air speed. This type is also encountered when speed is decreased (Figure 4-1).

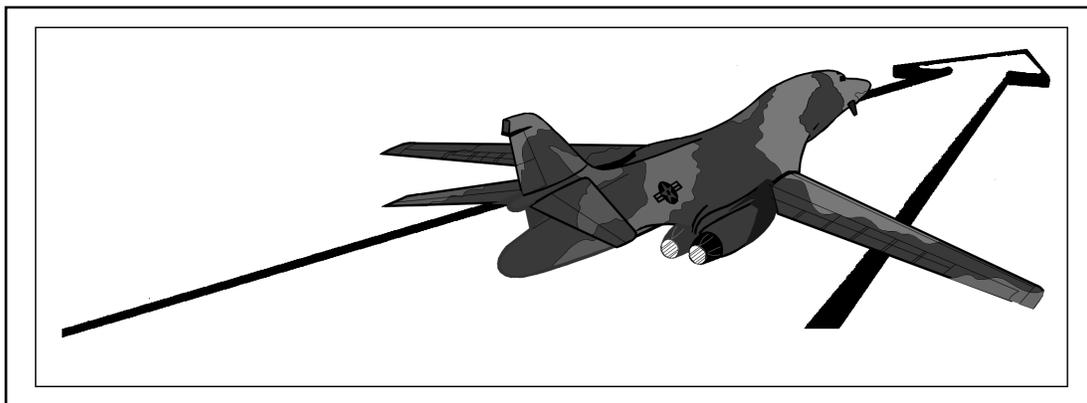

Figure 4-1. Linear Acceleration

#### RADIAL, OR CENTRIPETAL, ACCELERATION

4-4. This type of acceleration can occur in any change of direction without a change in speed. Crew members may encounter this type of acceleration during banks, turns, loops, or rolls (Figure 4-2).



Figure 4-2. Radial, or Centripetal, Acceleration

#### ANGULAR ACCELERATION

4-5. This type of acceleration is complex and involves a simultaneous change in both speed and direction. A good example of this is an aircraft that is put into a tight spin. For practical purposes, angular acceleration does not pose a problem in understanding the physiological effect of accelerative forces. Its principal effects are important, however, because they produce many of the disorientation problems encountered in flight (Figure 4-3).

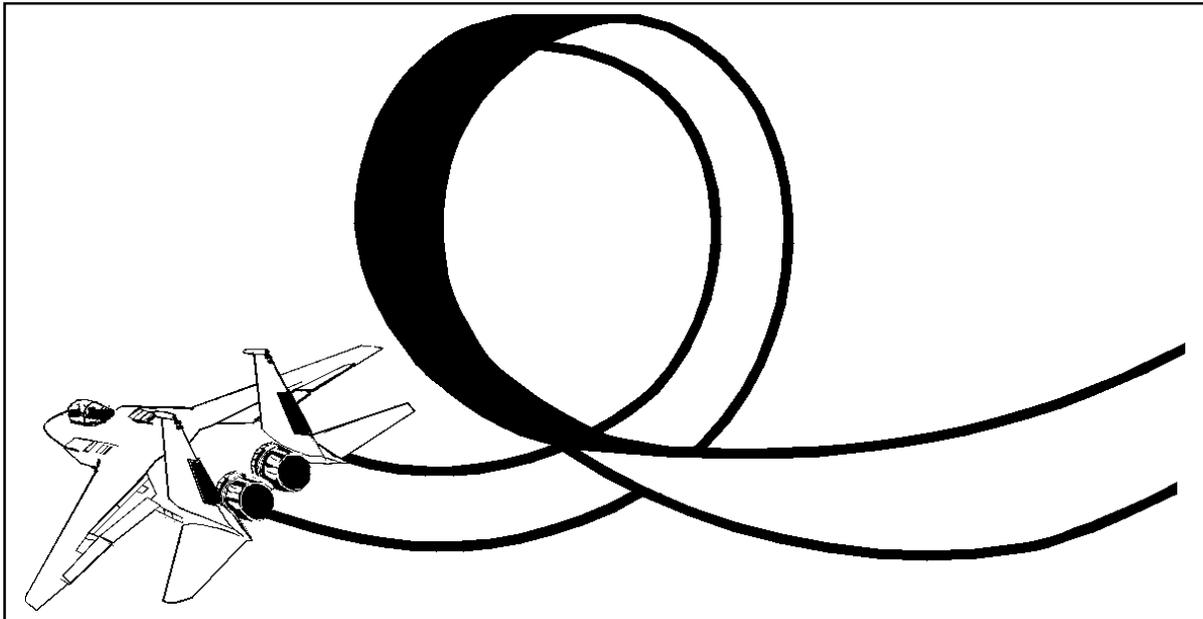

Figure 4-3. Angular Acceleration

## GRAVITATIONAL FORCES

4-6. Newton's three laws of motion describe the forces of acceleration. The first describes inertia, stating that a body remains at rest or in motion unless acted upon by a force. Newton's second law of motion states that, to overcome inertia, a force ( $F$ ) is required, the result of which is proportionate to the acceleration ( $a$ ) applied and the size of its mass ( $m$ ); that is,  $F = ma$ . Newton's third law states that for every action (acceleration centripetal force), there is an equal and opposite reaction (inertial centrifugal force).

4-7. The gravitational force (G-force) and the direction in which the body receives that force are important physiological factors that affect the body during acceleration. As shown in Figure 4-4, G-forces can affect the body in three axes:  $G_x$ ,  $G_y$ , and  $G_z$ . The physiological effects of prolonged acceleration depend on the direction of the accelerative (centripetal) force and, consequently, on how the inertial force acts upon the body. The inertial (centrifugal) force is always equal to, but opposite, the accelerative force. The inertial force is the most important physiologically. The various G-forces are explained below:

- Positive G, or  $+G_z$ , acceleration occurs when the body is accelerated in the headward direction. The inertial force acts in the opposite direction toward the feet, and the body is forced down into the cockpit seat.
- Negative G, or  $-G_z$ , acceleration occurs when the body is accelerated footward. The inertial force is toward the head, and the body is lifted out of the cockpit seat.

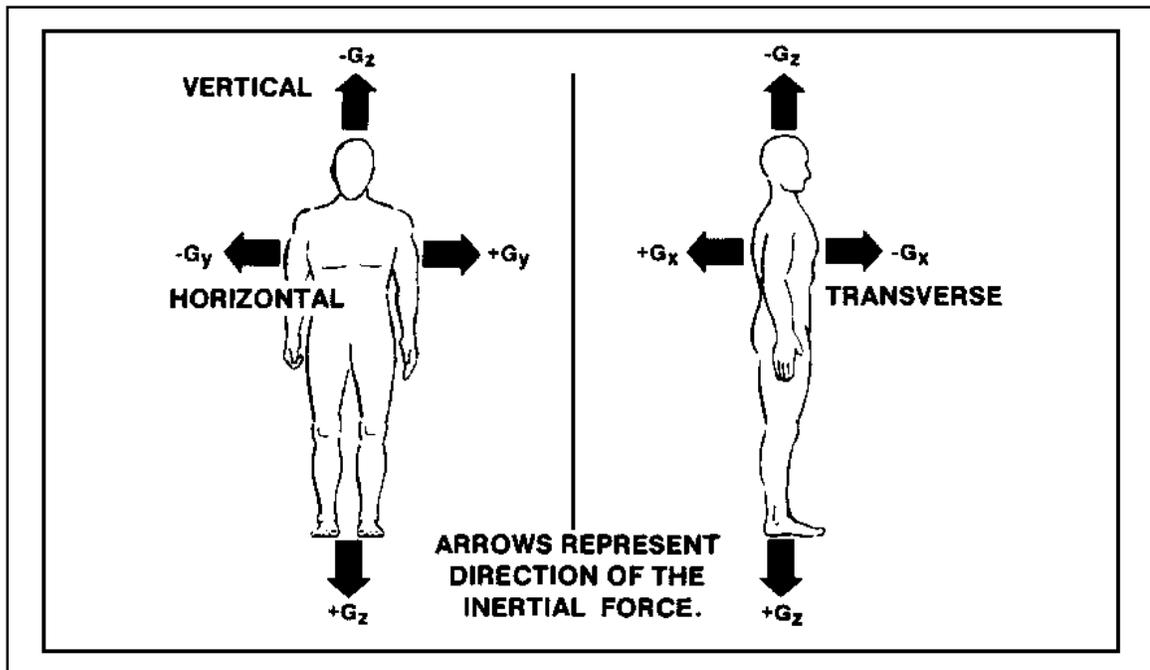

Figure 4-4. G-Force

- Forward transverse G, or  $+G_x$ , acceleration occurs when the accelerative force acts across the body in a chest-to-back direction. The G acceleration is experienced during acceleration.
- Backward transverse G, or  $-G_x$ , acceleration occurs when the accelerative force acts across the body in a back-to-chest direction. The  $-G_x$  acceleration is experienced during deceleration.
- Right- or left-lateral G, or  $+/-G_y$ , acceleration occurs when the accelerative force impacts across the body from a shoulder-to-shoulder direction.

## FACTORS AFFECTING ACCELERATIVE FORCES

4-8. To determine the effects of accelerative forces on the human body, crew members must consider several factors. These factors include intensity, duration, rate of onset, body area and site, and impact direction.

### INTENSITY

4-9. In general, the greater the intensity, the more severe are the effects of the accelerative force. However, intensity is not the only factor that determines the effects.

### DURATION

4-10. The longer the force is applied, the more severe are the effects. Crew members can tolerate high G-forces for extremely short periods and low G-forces for longer periods. In general, the longer the force is applied, the more severe the effects. A force of 5 Gs applied for 2 to 3 seconds is usually harmless, but the same force applied for 5 to 6 seconds can cause blackout or

unconsciousness. In ejection seats, pilots can tolerate a headward acceleration of 15 Gs for about 0.2 second without harm but will become unconscious when the same force is applied for 2 seconds. A force of 40 Gs received intermittently for fractions of a second during a crash landing is tolerable; if applied steadily for 2 to 3 seconds, the same force is fatal. The body can absorb, without harm, high G-forces applied for extremely short durations.

#### **RATE OF ONSET**

4-11. The rate of onset of accelerative or decelerative forces plays a part in the effects experienced. When an aircraft decelerates gradually, as in a wheels-up landing, the decelerative forces are exerted at a rather slow rate. Generally, when the rate of application is higher, such as when an aircraft decelerates suddenly during an accident, the effects are more severe. When an aircraft impacts vertically, the stopping distance is considerably shorter and the rate of application of accelerative forces is many times greater. The rate of application is often slowed down in helicopter crashes by the spreading of the skids and the crumpling of the fuselage, giving the body 3 or 4 extra feet in which to decelerate. Therefore, the distance, as well as the time, is an important factor in acceleration or deceleration. The shorter the stopping distance, the greater the G-force.

#### **BODY AREA AND SITE**

4-12. The size of the body area over which a given force is applied is important; the greater the body area, the less harmful are the effects. The body site to which a force is applied is also important. The accelerative effect of a given force, such as a blow to the head, is much more serious than the same force applied to another part of the body such as the leg.

#### **IMPACT DIRECTION**

4-13. The direction from which a prolonged accelerative force acts on the body also determines the physiological effects that occur. The body does not tolerate a force applied to the long axis of the body (Gz) as well as it does a force applied to the Gx axis (Figure 4-5).

#### **PHYSIOLOGICAL EFFECTS OF LOW-MAGNITUDE ACCELERATION**

4-14. The physiological effects of low-magnitude acceleration are the result of the inertial centrifugal force and the increased weight of the body and its components. Low-magnitude acceleration is described as Gs in the range of 1 to 10 with prolonged time of application lasting for at least several seconds. During aircraft maneuvers, the main part of the body affected by excessive G-forces is the cardiovascular system. The skeleton and soft tissues of the body can withstand such stress without problems. The circulatory system, however, consists of elastic blood vessels; to perform properly, the system needs a well-defined blood pressure and volume. Excessive gravitational forces, such as those experienced in prolonged acceleration, can disrupt the normal circulatory function.

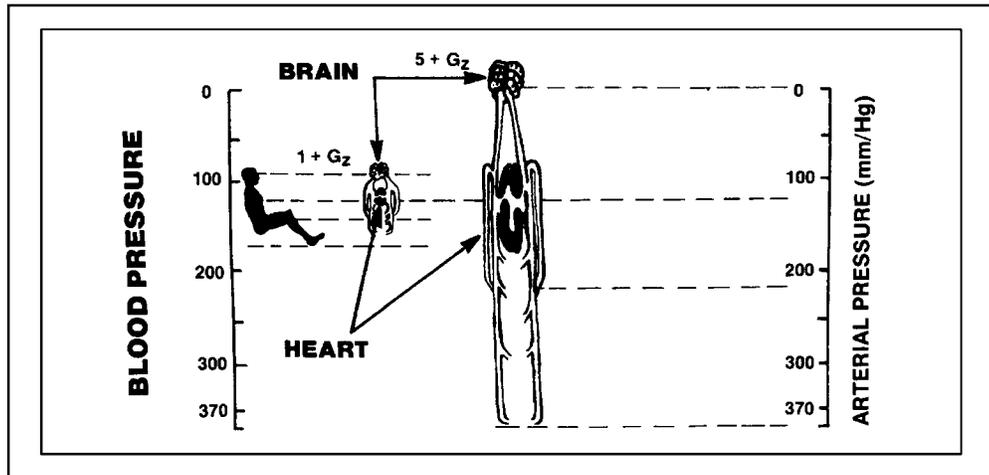

Figure 4-5. Impact Direction

## PHYSIOLOGICAL EFFECTS OF +G<sub>Z</sub> ACCELERATION

4-15. Positive G<sub>Z</sub> is acceleration in a headward direction such as the centripetal force experienced in a turn. The aircrew member is more aware of the centrifugal (inertial) force, which acts in the opposite direction, toward the feet. Crew members experience this force during pullout from a dive or execution of a high, banking turn.

4-16. During a maneuver that produces +G<sub>Z</sub>, the weight of the body increases in direct proportion to the magnitude of the force. For example, a 200-pound person weighs 800 pounds during a 4-G maneuver. Normal activities are greatly curtailed, and the person is pushed down into the seat. The arms and legs feel heavy, the cheeks sag, and the body becomes incapable of free movement. In fact, a pilot cannot escape unassisted from a spinning aircraft if the magnitude of the force exceeds 2 to 3 +G<sub>Z</sub>. This is the primary reason for the adoption of the pilot's ejection seat.

4-17. During a +G<sub>Z</sub> maneuver, the internal organs of the body are pulled downward. The increased weight of the internal organs pulls the diaphragm down, increases the relaxed thoracic volume, and disturbs the mechanics of respiration.

4-18. Comparing the body to a long cylinder helps explain the effects of a +G<sub>Z</sub> maneuver on the arterial blood pressure. In a seated individual, the heart lies approximately at the junction of the upper and middle thirds of the cylinder. The head and brain (the structures most sensitive to decreased blood pressure) are at the upper end of this vertical cylinder and about 30 centimeters from the heart. When a force of 5 +G<sub>Z</sub> is exerted on the body, a standing blood column of 30 centimeters exerts a pressure of 120 mm/Hg upon its base. Because this pressure is equal to the normal arterial systolic blood pressure, it exactly balances out the arterial pressure and causes the blood perfusion of the brain to cease. Unconsciousness can result when a force of 5 +G<sub>Z</sub> is applied to the body. Figure 4-6 shows the effects of 1 +G<sub>Z</sub> to 5 +G<sub>Z</sub> conditions.

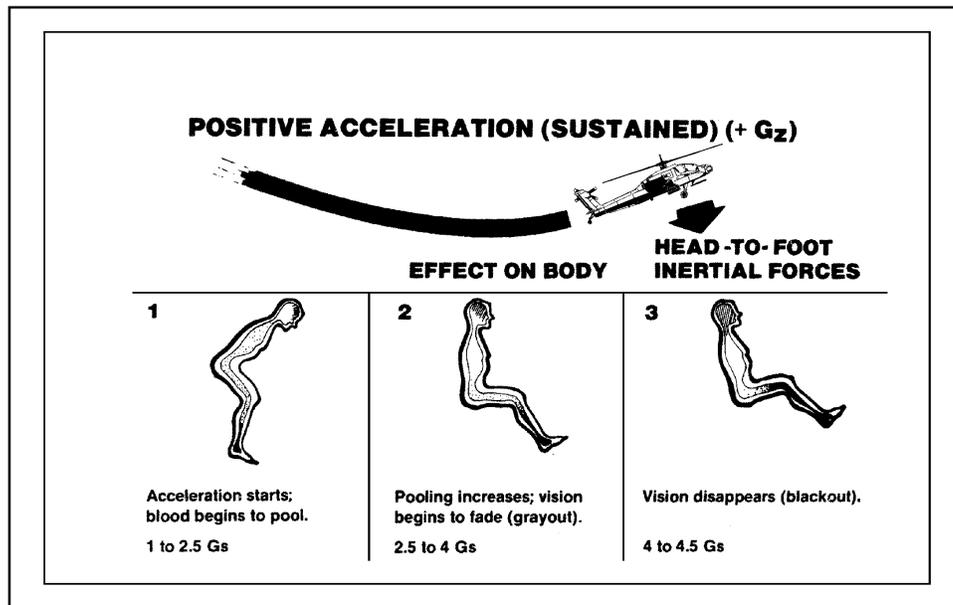

Figure 4-6. Positive Acceleration

4-19. At about 4 +G<sub>z</sub>—the point at which vision is completely lost before a loss of consciousness—blackout occurs. Static intraocular pressure is about 20 mm/Hg. When a positive G-force is sufficient to reduce the systolic arterial blood pressure in the head to 20 mm/Hg, the intraocular pressure causes the collapse of retinal arteries. The retina ceases to function as the blood supply fails, and the vision narrows from the periphery. At about 4 to 4.5 G<sub>z</sub>, vision disappears and blackout occurs. When the force reaches about 5 +G<sub>z</sub>, cerebral blood flow stops and unconsciousness ensues. Therefore, the sequence of events following exposure to +G<sub>z</sub> is the dimming of vision, blackout, and then unconsciousness.

4-20. The effects described above are usually progressive, as shown in Figure 4-6. In relaxed subjects in the human centrifuge, for example, the first symptoms from increased +G<sub>z</sub> forces occur at 2.5 to 4 +G<sub>z</sub> and involve a graying or dimming of the visual fields. At slightly higher accelerations (4 to 4.5 +G<sub>z</sub>), blackout occurs and individuals can no longer see although they remain conscious. The retinal arteries have collapsed, but some blood still flows through the blood vessels of the brain. At 4.5 to 5 +G<sub>z</sub>, unconsciousness occurs.

4-21. Blood pools in the lower extremities, and there is a relative loss of blood volume and blood pressure to the brain. Stagnant hypoxia and hypoxic hypoxia, caused by unoxygenated blood from impaired respiration, also occur. Oxygen saturation of the blood can fall from the normal 98 percent to 85 percent during an exposure of 7 +G<sub>z</sub> for 45 seconds.

4-22. With the loss of blood pressure and the hypoxic state combined, it may take up to one minute following the end of acceleration for an individual to

recover. After regaining consciousness, the crew member may still experience a period of disorientation and loss of memory for some time.

4-23. Although tolerance limits to G-forces are relatively constant from one person to another, certain factors decrease or increase an individual's tolerance to +Gz. These are the decremental and incremental factors.

### **DECREMENTAL FACTORS**

4-24. Any factor that reduces the overall efficiency of the body, especially the circulatory system, causes a marked reduction in an aircrew member's tolerance to +Gz. Loss of blood volume, varicose veins, and decreased blood pressure (chronic hypotension) can affect the circulatory system. Self-imposed stress, such as that caused by alcohol abuse, also affects the aircrew member's tolerance to +Gz.

### **INCREMENTAL FACTORS**

4-25. The L-1 maneuver is an Anti-G Straining Maneuver (AGSM) that increases the crew member's G-tolerance. For protection that does not overstress the larynx, crew members can use the L-1 maneuver. In this maneuver, crew members maintain a normal upright sitting position, tense skeletal muscles, and simultaneously attempt to exhale against a closed glottis at two- to three-second intervals. Although the L-1 maneuver was developed by the Air Force for its fighter pilots, rotary-wing crew members experiencing gray-out conditions will also benefit from this maneuver.

### **PHYSIOLOGICAL EFFECTS OF -Gz ACCELERATION**

4-26. When the accelerative force acts on the body in a direction toward the feet, as would be experienced in a rapid descent, -Gz occurs. In this case, the accelerative (centripetal) force acts toward the axis of the turn. Actually, -Gz does not present a great problem in military flying. Because it is an uncomfortable experience, pilots tend to avoid it.

4-27. Negative acceleration, inertial force applied from foot to head, causes a sharp rise in arterial and venous pressures at the head level. The increased pressure within the veins outside the cranial cavity may be sufficient to rupture the thin-walled venules (small veins). The intracranial venous pressure also rises, but it is counterbalanced by an accompanying rise in intracranial cerebral spinal-fluid pressure. Therefore, there is little actual danger of intracranial hemorrhage or cerebral vascular damage as long as the skull remains intact. Hemorrhages within the eye present the primary source of damage from -Gz. Distension of the jugular veins and veins of the sinuses and conjunctiva is caused by -Gz.

4-28. Sudden acceleration producing a force of 3 -Gz reaches the limit of human tolerance. When such a force is applied, venous pressure of 100 mm/Hg develops and causes small conjunctival bleeding areas and marked discomfort in the head region.

4-29. During -Gz maneuver, redout may be experienced (Figure 4-7). This phenomenon occurs when the gravitational pull acts on the lower eyelid,

causing the lower eyelid to cover the cornea. The constant pull of gravity on the lower eyelids tends to weaken their muscles.

4-30. If sufficiently prolonged, a gravitational pull in the foot-to-head direction also leads to eventual circulatory distress. Pooling of blood occurs in the head and neck regions, which then leads to a passage of fluid from the blood to the tissue spaces of the head and neck. In addition, the return of blood to the heart becomes inadequate because of the loss of the effective blood volume. Therefore, blood stagnates in the head and neck. The cerebral-arterial and venous pressure differential is inadequate to sustain consciousness.

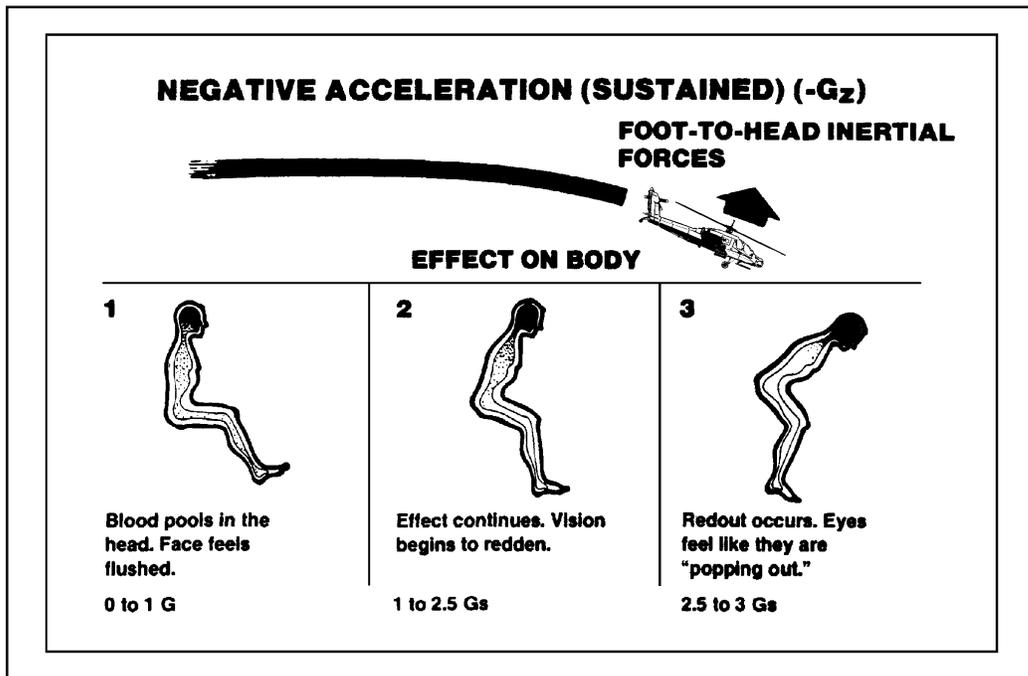

Figure 4-7. Negative Acceleration

### PHYSIOLOGICAL EFFECTS OF +/-G<sub>x</sub> ACCELERATION

4-31. Transverse-G occurs when the accelerative force impacts across the body at right angles to the long axis. The inertial (centrifugal) force will also cross the body—in the opposite direction. Aircrew members undergo mild transverse acceleration during takeoffs and landings. The physiological effects of transverse acceleration are important in manned space missions; they are experienced during initial lift-off and reentry.

4-32. Individual are more tolerant of forces received in the +/-G<sub>x</sub> axis than of those received in the other axes because transverse Gs interfere very little with blood flow. Extreme values of transverse G (12 to 15 +/-G) acting for five seconds or more can displace organs or shift the heart's position and, thereby, interfere with respiration.

4-33. At levels above 7 +G, breathing becomes harder because of the effect on the chest movement. Some individuals, however, have withstood levels of 20 +G for several seconds with no severe difficulty.

### **PHYSIOLOGICAL EFFECTS OF +/-GY ACCELERATION**

4-34. The human body has minimal tolerance to Gy (right- or left-lateral) acceleration. Most aircraft do not normally apply significant accelerative forces in the lateral direction. Therefore, this type of G-force is of little significant during low-magnitude acceleration.

### **PHYSIOLOGICAL EFFECTS OF HIGH-MAGNITUDE ACCELERATION AND DECELERATION**

4-35. High-magnitude acceleration and deceleration affect aircraft accident survivability. High-magnitude acceleration occurs when acceleration exceeds 10 Gs and lasts for less than one second. The effects of high-magnitude acceleration are usually the result of linear acceleration. The terms acceleration and deceleration (negative acceleration) are synonymous when used to describe the forces encountered in aircraft crashes, ejection-seat operations, and parachute-opening shock.

### **HIGH-MAGNITUDE ACCELERATION**

4-36. Adverse effects and injury result from the abruptness and magnitude of forces. Other factors are the body area to which the force is applied and the extent of distortion in shearing, compressing, or stretching body structures. The severity of effects progresses from discomfort, incapacitation, minor injury, and irreversible injury to lethal injury. A thorough examination of the cause of the injury and the effects on the body is essential for determining survival limits and for devising protective and preventive measures.

### **HIGH-MAGNITUDE DECELERATION**

4-37. Several factors cause the adverse effects of high-magnitude decelerative forces. These factors are the—

- Degree of intensity of the acceleration, known as the “peak G.”
- Duration of the “peak G” and the total time of the deceleration.
- Rate of application or rate of onset of the acceleration, known as the “jolt.” The jolt, expressed in feet per second or Gs per second, is the rate of change of acceleration or the rate of onset of accelerative forces.
- Direction or axis of force application that determines whether acceleration or deceleration occurs.

### **CRASH SEQUENCE**

4-38. During the accident sequence, the aircraft occupants' survival depends on three criteria. These criteria are the crash forces transmitted to the occupants, occupiable living space, and aircraft design features.

## Crash Forces

4-39. The intensity of the decelerative force to which the body is subjected is not a single decelerative G; instead, crash forces produce a series of decelerations, at various G-loads, until all motion is stopped (Figure 4-8). In addition, these crash forces occur in all three axes (Gx, Gy, and Gz) at the same time (Figure 4-9). The tolerance limits to high-magnitude deceleration vary with the duration of the force and direction. The human body, however, is far more vulnerable to injury when exposed to a series of high-G shocks in all three axes. As Figure 4-9 shows, the human body can withstand these forces only for an extremely short time (less than 0.1 second). If this is exceeded, injury or death occurs.

## Occupiable Living Space

4-40. The occupants' living space influences survivability and must not be compromised either by failure of the airframe or by possible penetration of the cabin area by outside objects. If either human-tolerance limits to decelerative forces are exceeded or living space is lost, survivability in an accident sequence decreases significantly. To provide maximum protection to aircrew members during an accident, certain design features can be built into an aircraft to absorb crash forces. The UH-60 (Black Hawk) shows that a crashworthy design is possible (Figure 4-10).

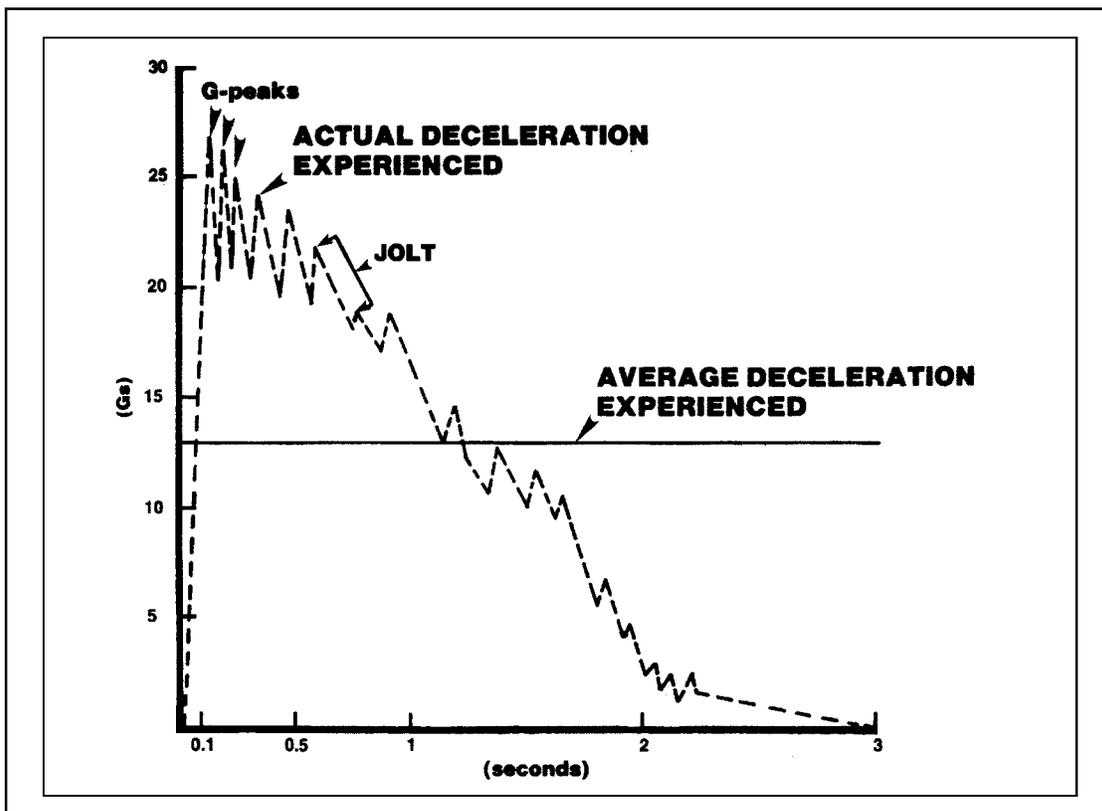

Figure 4-8. Decelerative Forces Experienced During an Accident of Three-Second Duration

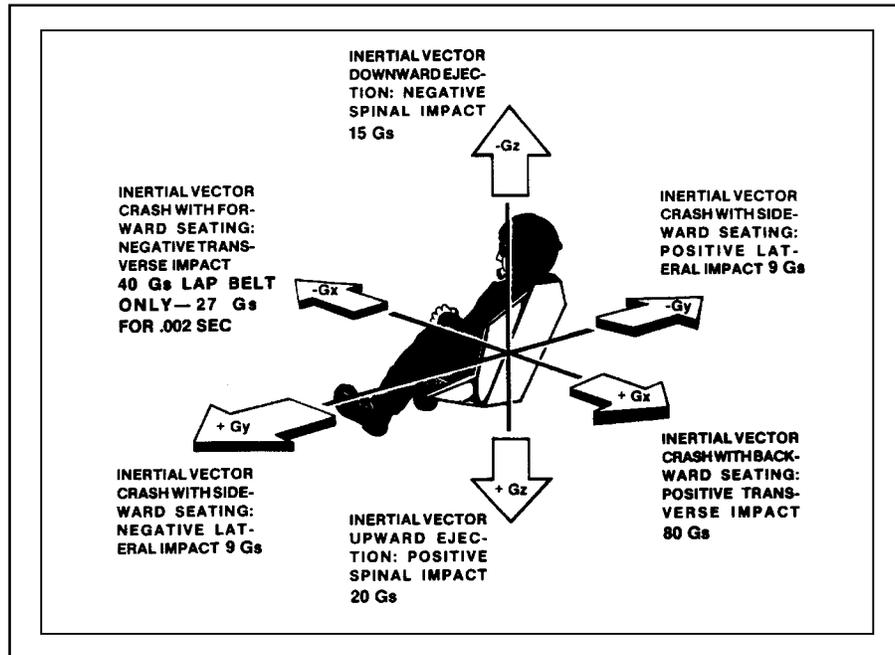

Figure 4-9. Human-Tolerance Limits to Whole-Body Impact (Duration 0.1 Second)

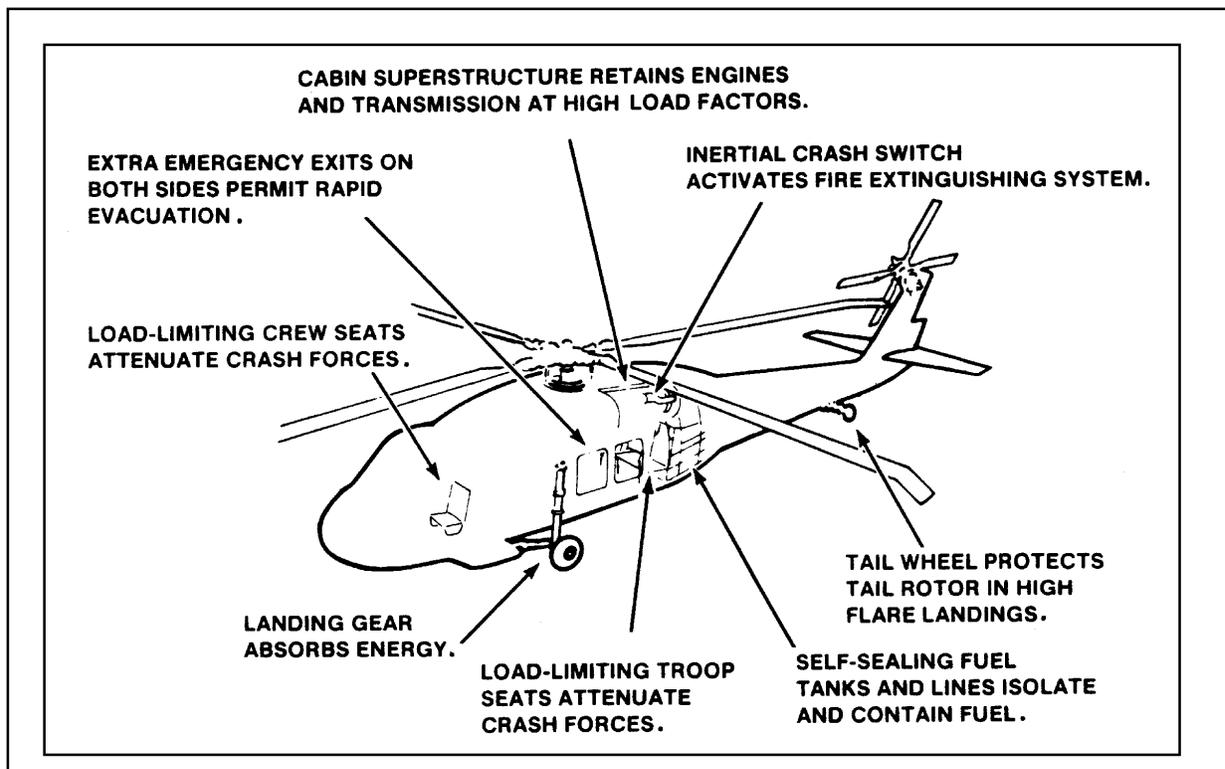

Figure 4-10. Crashworthy Design Features of the UH-60 (Black Hawk)

## Aircraft Design Features

4-41. Design features that aid crash survival are commonly referred to as the CREEP factors. These factors are explained below:

- **C—Container.** An aircraft must be designed with an effective protective shell around the occupants. Its maximum structural and component weight should be below the occupants to reduce cabin crushing by inertial loading. The airframe should contain crushable material to attenuate crash forces before they are transmitted to the crew members. Fuel cells (tanks) should be of crashworthy design and be protected by the airframe to prevent outside objects from penetrating them.
- **R—Restraint Systems.** Restraint systems should attenuate crash forces and protect the occupants in all conditions of flight. These systems should be comfortable to wear and not interfere with cockpit duties. The head is the most likely point of injury in an accident sequence; therefore, occupants should use shoulder harnesses to minimize upper-body motion. A failure in any part of the restraint system—seat, seat belt, or anchor points—results in a higher degree of exposure to injury.
- **E—Environment.** The cockpit and cabin area must be “delethalized” to include adequate equipment restraints for withstanding crash forces.
- **E—Energy Absorption.** With their energy-absorbing features, aircraft are designed to withstand disruptive forces. Some features are the aircraft undercarriage, landing gear, and seat design that deform during the accident sequence. These modify high-peak G-loads of short duration into more survivable G-loads of longer duration.
- **P—Postcrash Protection.** Two major postcrash factors must be considered: fire and evacuation. The crashworthy fuel system has drastically reduced the fire hazard in Army aircraft accidents. However, timely evacuation is still desirable. The timeliness in evacuating aircraft occupants who survive an impact is often governed by the adequacy of emergency exits. Other factors that enhance timely evacuation are convenience of location, ease of operation (the UH-1 cargo door window is a prime example), and adequacy of markings.

## PREVENTIVE MEASURES

### INCREASE THE AREA TO WHICH THE FORCE IS APPLIED

4-42. This is accomplished through a variety of methods. The HGU-56/P protective helmet distributes pinpoint pressure over a larger area and reduces the chance of head injury. Seat belts with shoulder harnesses distribute decelerative forces over a larger area of the body and help prevent hazardous contact with the cabin environment. Backward seating arrangements also distribute decelerative forces normally found in the accident sequence.

**INCREASE THE DISTANCE OVER WHICH THE DECELERATION OCCURS**

4-43. The built-in design features of the aircraft can absorb and dissipate much of the kinetic energy during the crash. These features increase the distance over which the deceleration occurs.

**ALIGN THE BODY TO TAKE ADVANTAGE OF THE STRUCTURAL STRENGTH OF THE MUSCULOSKELETAL SYSTEM**

4-44. The correct alignment of the body is a preventive measure that can be taken during a crash. Crew members can align the body to take advantage of the structural strength of the musculoskeletal system, especially during the accident sequence. The proper use of seat belts, the shoulder harness, or the crash position (with the body bent forward) ensures that the strongest parts of the body absorb the crash forces.

## Chapter 5

# Toxic Hazards in Aviation

The effects of toxic chemicals in the aviation environment may lead to human error, which is the leading cause of aviation accidents. During flight, the exposure of aircrews to toxins can range from an acute and suddenly incapacitating event to long-term health effects secondary to chronic exposure. Aviation personnel must be able to understand the dangers and recognize the often near-imperceptible onset of toxic hazards. The flight surgeon or aeromedical physician's assistant should educate the aircrew in the prevention of toxic hazards and treatment of flight personnel who are exposed to known toxic chemicals.

### SECTION I – AVIATION TOXICOLOGY PRINCIPLES

#### ENVIRONMENT

5-1. In aviation, the unique toxicological environment is primarily limited to an enclosed environment. Thus, this chapter's focus is on aircraft cockpit exposures. Included, however, are some important issues facing Class III supply personnel.

#### ACUTE TOXICITY

5-2. The greatest toxicological risk during flight is an acute, high-dose exposure to a toxic agent. The cabin air quality may change rapidly or insidiously. These air-quality changes can be due to the generation of toxic substances from fluid leaks, fire, and/or variations in altitude and ventilation rates.

5-3. Exposure to chemical fumes from burning wire insulation or rocket exhaust can degrade a pilot's ability to function. Acute in-flight exposures are of two types:

- Suddenly incapacitating exposures.
- Subtle, performance-decrement exposures.

Exposures to toxic chemicals have contributed to some accidents erroneously attributed to pilot error. During the most demanding modes of flight, the balance between critical flight tasks and human abilities is sometimes delicate and fragile even for well-trained crews. Therefore, any performance decrement caused by toxic substances is a cause for concern.

## **CHRONIC TOXICITY**

5-4. During both ground-support and aviation operations, chronic (long-term) exposure to potentially toxic agents may occur. Handling munitions and propellants and storing fuels and fluids pose special problems.

## **TIME AND DOSE RELATIONSHIP**

5-5. With most substances, the medical effects of an exposure depend on the duration of exposure and the concentration of the chemical. As the concentration increases, the interval between initial exposure and the onset of symptoms decreases. Many chemicals change their adverse physical effects as the concentrations increase. At high concentrations, gases, such as nitrogen dioxide, and numerous petrochemicals and other mechanical fluids are highly irritating to the upper respiratory tract, nasal passages, and mucous membranes; at lower concentrations, these chemicals may have little or no effect.

## **PHYSIOCHEMICAL FACTORS**

5-6. Specific organs or tissues selectively absorb a chemical substance as it enters the bloodstream. For example, fat-soluble compounds, such as carbon tetrachloride and most aviation fuels, tend to accumulate in the nervous system tissues. Heavy metals from lead-acid batteries tend to produce damage at the point of exit from the bloodstream—the kidneys.

## **ENTRY POINTS**

5-7. Toxic agents may enter the body by inhalation into the lungs, by ingestion into the stomach, or by absorption through the skin. The most important route of entry in the aviation environment is inhalation. Aircrews are often in close contact with volatile fuels and other potentially hazardous petroleum products, oils, lubricants, and hydraulic fluids. For example, a well-intentioned crew chief may choose to eat while working on the engine deck without realizing the potential danger of ingesting a toxin through contaminated food or water. Another example is the crew member, in a hurry after an aircraft refueling, who chooses not to wash his hands and then smokes a cigarette or eats a meal. Acute toxic exposures are characteristically related to inhalation or ingestion, whereas toxin exposure through skin absorption usually produces symptoms only after chronic, repeated exposures.

## **PREEXISTING CONDITIONS**

5-8. People with organ impairment—such as liver or lung damage, sickle-cell disease, or an active disease process—are usually more susceptible to toxic agents. Various toxic agents in the presence of another specific chemical can combine or accelerate their adverse effects on the individual. Examples include smoking and asbestosis exposures as well as carbon monoxide and another agent that has already reduced the oxygen-transport capabilities in

the blood. Increased altitude and temperature can also accelerate the effects of toxic chemicals.

## **INDIVIDUAL VARIABILITY**

5-9. Allergies can influence an individual's physical response to an allergen. The allergic physical response to a toxic agent can vary considerably. For example, in an environment in which several people are in daily contact with a specific chemical at low concentration, only one person may exhibit signs/symptoms because of his unique genetic characteristics such as metabolic rate, retention and excretion rates, and level of physical fitness.

## **ALLOWABLE DEGREE OF BODILY IMPAIRMENT**

5-10. Even a slight degree of in-flight impairment is hazardous to the pilot's task. The flight surgeon, working with the industrial hygienist, should be aware of chemicals within the flight-line area of responsibility to ensure that personnel exposure remains within safe limits. Several methods of quantifying the hazard risk to routine chemical exposures have been established.

## **THRESHOLD LIMIT VALUES**

5-11. TLVs are chemical concentration limits. These values are time-weighted, average concentrations of chemicals that should produce no apparent adverse effects for individuals who are routinely exposed for eight hours a day. TLVs are usually measured in parts per million for gases and vapors and in milligrams per cubic meter for fumes and dusts.

## **SHORT-TERM EXPOSURE LIMITS**

5-12. STELs are the maximum time-weighted average concentrations of specific chemicals that are allowed for only 15 minutes during the workday. They were developed to protect against acute toxicity. STELs should not be reported more than four times a day.

## **CEILING CONCENTRATION**

5-13. Ceiling concentration is the maximum allowable concentration of a specific chemical that must never be exceeded during any part of the workday. Even an instantaneous value in excess of the TLV ceiling is prohibited.

## **BODY DETOXIFICATION**

5-14. The human body has varied and intricate chemical defense mechanisms. Upon entry of a toxic substance, the body immediately begins to reduce the concentration of the substance by multiple processes. These processes includes metabolism (the chemical breakdown of a substance), detoxification, and excretion. The flight surgeon must be familiar with the metabolic pathways of well-known poisons and understand the physical or psychological symptoms attributable to a subtle chemical intoxication. For

example, the amount of carbon monoxide eliminated by the body during a single exposure decreases by 50 percent every four hours.

## SECTION II – AIRCRAFT ATMOSPHERE CONTAMINATION

### CONTAMINATION OVERVIEW

5-15. The interior of an aircraft may contain various contaminants that could present a risk, depending on the mission and other circumstances. Aircrews and ground crews transporting hazardous cargo should refer to ARs 50-5, 50-6, 95-1, and 95-27 and TM 38-250. Information concerning an NBC environment is beyond the scope of this field manual but may be found in FMs 3-04.400(1-400), 3-11.5(3-5), and 3-11.100(3-100) and TM 3-4240-280-10. FM 8-9 contains more detailed medical information on the NBC environment. Aircraft atmosphere contamination can include—

- Exhaust gases.
- Tetraethyl lead.
- Carbon monoxide.
- Engine lubricants.
- Oxygen contaminants.
- Jet-propulsion fuels.
- Coolant fluid vapors.
- Fluorocarbon plastics.
- Hydraulic fluid vapors.
- Fire-extinguishing agents, including halogenated hydrocarbons.

### EXHAUST GASES

5-16. The physical relationship of engine positioning to the cockpit is important. Depending on the age of the aircraft and the power plant used (jet or reciprocating), there will be a wide range of potential cockpit air contaminants caused by exhaust gases. Single-engine, piston-type aircraft with the engine located directly in front of the fuselage are subject to greater contamination than multiengine aircraft with engines situated laterally. Reciprocating engines uniformly produce much more carbon monoxide in their exhaust than the modern jet engine. Liquid-cooled, single-engine airplanes are also less likely to be contaminated by exhaust gases than air-cooled, radial-engine airplanes.

### CARBON MONOXIDE

5-17. The effects of carbon monoxide are subtle and deadly. Carbon monoxide, a product of incomplete combustion, is the most common gaseous poison in the aviation environment. It is also the most common unintentional and intentional cause of poisoning in the United States. More deaths have been attributed to CO than to any other toxic gas. Carbon monoxide acts as a tissue asphyxiant that produces hypoxia at both sea level and altitude. It preferentially combines with hemoglobin, to the partial exclusion of oxygen,

and thus, interferes with the uptake of oxygen by the blood. CO has a 256-times greater affinity for bonding with hemoglobin than with oxygen. The presence of CO greatly reduces the oxygen-carrying capability of hemoglobin. It is a colorless, odorless gas that is slightly lighter than air. Because it is odorless, CO should be suspected whenever exhaust odors are detected. Carbon-monoxide concentration in the blood is based on a variety of factors, including the concentration of the gas, respiratory rate, CO saturation of hemoglobin, and duration of exposure. Table 5-1 shows the body's physiological response to various concentrations of carbon monoxide.

**Table 5-1. Physiological Response to Various Concentrations of Carbon Monoxide**

Carbon Monoxide Concentration in Air (ppm)	Carboxyhemoglobin Saturation in Blood (%)	Exposure Time	Symptoms
0-50	—	—	No appreciable effect
0-100	0-17	—	No significant effects, except for possible headache and flushing of skin
200-300	23-30	5-6 hr	Weakness, headache, dizziness, loss of visual acuity, nausea, and vomiting
400-600	36-44	4-5 hr	Same as above, with muscular incoordination
700-1,000	47-53	3-4 hr	Same as above, with increased pulse and respiration
1,100-1,500	55-60	1.5-3 hr	Coma
1,600-2,000	61-64	.5-1 hr	Depressed heart rate and respiration
5,000-10,000	73-76	2-15 min	Death

5-18. A relatively low concentration of CO in the air can, in time, produce high blood concentrations of CO. A person who inhales a 0.5 percent concentration of CO for 30 minutes while at rest will have a 45 percent blood concentration of CO. As noted in Table 5-1, this is sufficient to produce a near-coma condition.

5-19. A reduced concentration of oxygen in the air and increased temperature or humidity may increase the concentration of CO-bound hemoglobin. Any of these changes or an increase in physical activity can accelerate the toxic effects of CO.

5-20. Production of carbon monoxide depends upon incomplete combustion of fuel. An engine that yields complete combustion will produce only carbon dioxide. As the fuel-to-air ratio decreases and complete combustion increases, the percentage of carbon dioxide in the exhaust gas rises and the percentage of carbon monoxide declines. Conversely, as the mixture becomes richer (increasing the fuel-to-air ratio), the carbon monoxide in the exhaust gas increases.

5-21. The effects of carbon monoxide on the human body vary. The leading symptoms of carbon monoxide intoxication are—

- Tremors.
- Headache.
- Weakness.
- Joint pain.
- Hoarseness.
- Nervousness.
- Muscular cramps.
- Muscular twitching.
- Loss of visual acuity.
- Impairment of speech and hearing.
- Mental confusion and disorientation.

5-22. The symptoms are those of hypemic hypoxia. Of particular importance to aviators is the loss of visual acuity. Peripheral vision and, more importantly, night visual acuity is significantly decreased, even with blood CO concentrations as low as 10 percent saturation.

5-23. The dangers associated with carbon monoxide rise sharply with increasing altitudes. When experienced separately, a mild degree of hypoxic hypoxia (caused by altitude increases and decreased partial pressures of oxygen) or an exposure to small amounts of carbon monoxide may be harmless. When experienced simultaneously, their effects become additive. They may cause serious pilot impairment and result in loss of aircraft control.

5-24. For practical purposes, the elimination rate of carbon monoxide depends on respiratory volume and the percentage of oxygen in the inspired (inhaled) air. Smoking one to three cigarettes in rapid succession or one and one-half packs per day can raise an individual's carbon-monoxide hemoglobin saturation to 10 percent. At sea level, it may take a full day to eliminate that small percentage of carbon monoxide because the carbon-monoxide gas is reduced by a factor of only 50 percent about every four hours.

5-25. When flight personnel suspect the presence of carbon monoxide in the aircraft, they should turn off exhaust heaters, inhale 100 percent oxygen (if available), and land as soon as practical. After landing, they can investigate the source and evaluate their own possible symptoms of carbon-monoxide intoxication.

## **AVIATION GASOLINE**

5-26. AVGAS is used only as an emergency fuel. It is a mixture of hydrocarbons and special additives such as tetraethyl lead and xylene. One gallon of aviation gasoline that has completely evaporated will form about 30 cubic feet of vapor at sea level. Flight personnel who have been exposed to aviation gasoline vapors can have adverse physical or psychological reactions.

5-27. Aviation gasoline vapors, which are heavier than air, are readily absorbed in the respiratory system and may produce symptoms of exposure after only a few minutes. If vapors are inhaled for more than a short time, one-tenth of the concentration that could cause combustion or explosion may cause unconsciousness. The maximum safe concentration for exposure to vapors of ordinary fuel is about 500 parts per million, or 0.05 percent. Aviation gasoline vapor is at least twice as toxic as ordinary fuel vapor. Exposure to aviation gasoline may include—

- Burning and tearing of the eyes.
- Restlessness.
- Excitement.
- Disorientation.
- Disorders of speech, vision, or hearing.
- Convulsions.
- Coma.
- Death.

## **TETRAETHYL LEAD IN AVIATION GASOLINE**

5-28. Tetraethyl lead, an antiknock substance, is highly toxic. Poisoning may occur by absorption of the lead through the skin or by inhalation of its vapors. Tetraethyl lead poisoning primarily affects the central nervous system. Symptoms include insomnia, mental irritability, and instability. In less dramatic cases, sleep may be interrupted with restlessness and terrifying dreams. Other symptoms include nausea, vomiting, muscle weakness, tremors, muscular pain, and visual difficulty. The amount of tetraethyl lead in aviation gasoline is so small that a lead hazard through normal handling is remote; the amount is only about 4.6 cubic centimeters per gallon, or about one teaspoon. Poisoning has resulted from personnel entering fuel-storage tanks containing concentrated amounts of tetraethyl lead within the accumulated sludge. Maintenance personnel who work (welding, buffing, or grinding) on engines that have burned leaded gasolines can receive significant exposure to lead compounds.

## **JET PROPULSION FUELS**

5-29. JP-4, JP-5, and JP-8 are mixtures of hydrocarbons, producing different grades of kerosene. Each JP fuel has a specific vapor pressure and flash point. JP fuels do not contain tetraethyl lead. The recommended threshold limit for JP fuel vapors has been set at 500 parts per million. Toxic symptoms can occur below explosive levels; therefore, a JP fuel intoxication can exist even in the absence of a fire hazard. In addition to being an irritant hazard to skin and mucous membranes, excessive inhalation of JP fuels degrades central nervous system functioning. JP fuels, in high enough concentrations, can produce narcotic effects.

## HYDRAULIC FLUID VAPORS

5-30. A leak from a hydraulic hose or gauge, under pressures of up to 1,200 pounds per square inch, can produce a finely divided aerosol fluid that diffuses quickly throughout the cockpit. Large leaks may cause liquid to accumulate on the floor. In either case, the cockpit air may quickly develop a high level of aerosolized hydraulic fluid. Like other hydrocarbons, hydraulic fluid can be toxic when inhaled. In fact, several hydraulic fluids are phosphate ester-based and have identical actions as the military nerve agents known as organophosphoesterase inhibitors. Increasing temperature or altitude can aggravate the toxic effects of inhaling the aerosolized fluid. The toxic effects may include—

- Irritation of the eyes and respiratory tract.
- Headache.
- Vertigo.
- Nerve dysfunction in the limbs.
- Impairment of judgment and vision.

## COOLANT-FLUID VAPORS

5-31. The coolant fluid used in liquid-cooled engines consists of ethylene glycol diluted with water. Ethylene glycol is toxic when ingested. Although volatile, its vapors rarely exert any significant acute toxic effects when inhaled. However, with continued exposure to ethylene-glycol vapors, the respiratory passages become moderately irritated.

5-32. Ruptured coolant lines frequently result in smoke in the cockpit, either from the engine overheating or from leaking fluid. Smoke in the cockpit is always a concern for pilots; some have abandoned their aircraft because of coolant-line leaks. The flash point of pure ethylene glycol is 177 degrees Fahrenheit; however, the fire hazard from escaping coolant-fluid ignition is not especially great because the ethylene glycol has been diluted with water.

## ENGINE LUBRICANTS

5-33. The oil-hose connections in aircraft consist of the various types of adjustable clamps in contrast to the pressure-type connections used in the hydraulic system. Hose clamps occasionally break or loosen. When oil escapes onto hot engine parts, smoke often forms and enters the cockpit. Inhaling hot oil fumes causes symptoms similar to those of carbon monoxide poisoning:

- Headache.
- Nausea.
- Vomiting.
- Irritation of the eyes and upper-respiratory passages.

## FIRE-EXTINGUISHING AGENTS

5-34. Fire-extinguishing agents can pose a toxic threat to the aircrew fighting a fire, especially within an enclosed cabin or cockpit. Crew members could come into contact with these agents by using portable extinguishers. They

may also be exposed to gaseous fire-fighting agents in the ventilation system when automatic or semiautomatic fire-extinguishing systems aboard the aircraft are discharged. Ground-support personnel could also inhale fire-extinguisher agents but to a lesser extent because of the nonenclosed environmental conditions. The three chemical classes of fire-extinguishing agents in use today are—

- Halogenated hydrocarbons.
- Carbon dioxide.
- Aqueous film forming foam.

### **HALOGENATED HYDROCARBONS**

5-35. The halogenated hydrocarbon group is composed of carbon tetrachloride, or CCl<sub>4</sub>; chlorobromomethane, or CB; dibromodifluoromethane, or DB; and bromotrifluoromethane. Because of their toxicity, these halogenated hydrocarbons are no longer used to fight fires. The most common halogenated hydrocarbon in current use as a fire-extinguishing agent is Halon.

5-36. Halon is frequently seen on the flight line and used in automatic fire-suppression systems for large electrical/computer areas. It has excellent fire-suppression properties without chemical residuals. Halon has specific numbers associated with it, depending on its particular chemical composition of carbon, chloride, fluorine, and bromide. Halon is an excellent fire extinguisher and is relatively nontoxic to personnel except when extensively discharged in an enclosed space. Within a confined area, Halon acts as a simple asphyxiant (displaces oxygen from the room upon release). Under extremely high temperatures, this gas can decompose into other more toxic gases such as hydrogen fluoride, hydrogen chloride, hydrogen bromide, and phosgene analogues. In addition, the discharge of Halon from a compressed state can generate impulse-noise levels of more than 160 decibels. Halon is being removed from all but mission-essential areas because of its strong tendency to deplete the atmospheric ozone layer.

5-37. Phosgene (a thermal by-product of Halon), carbon tetrachloride, and the burning plastics significantly irritate the lower respiratory tract. Exposures to sublethal concentrations of this gas may permanently damage the respiratory system.

### **CARBON DIOXIDE**

5-38. As a fire extinguisher, carbon dioxide becomes a hazard because large quantities of the gas are required to extinguish a fire. At low concentrations, carbon dioxide acts as a respiratory stimulant. Beyond this concentration, inhaling 2 to 3 percent concentrations results in a feeling of discomfort and shortness of breath. A person can tolerate up to 5 percent concentrations for 10 minutes. A concentration of about 10 percent appears to be about the maximum exposure that a person can tolerate before performance deteriorates. A concentration above 20 percent can induce unconsciousness within several minutes.

5-39. Initial acute exposures (less than 2 percent) of carbon dioxide may result in excitement or increases in breathing rate and depth, heart rate, and blood pressure. These effects are followed by—

- Drowsiness.
- Headache.
- Increasing difficulty in respiration.
- Vertigo.
- Indigestion.
- Muscular weakness.
- Lack of coordination.
- Poor judgment.

Beginning with 10 percent concentrations, an aircrew member may experience mental degradation, collapse, and death. When the concentration increases slowly, symptoms appear more slowly and have less effect because the defenses of the body have time to act. Although aware of the changes occurring, the individual may be unable to assess the situation and take corrective action.

5-40. Because carbon dioxide is heavier than air, it accumulates in lower positions of enclosed spaces. Normal air becomes diluted, and the carbon dioxide acts as a simple asphyxiant. Aircrews must be indoctrinated to the hazards of carbon-dioxide poisoning. When the initial symptoms of carbon dioxide are detected in the cabin area, it must be ventilated quickly. The crew should use 100 percent oxygen if it is available on the aircraft.

### **AQUEOUS FILM-FORMING FOAM**

5-41. AFFF is a protein-based material used to physically separate a flammable liquid (fuel) from its oxygen source. It is essentially nontoxic, even if ingested, but will irritate the eyes and skin, similar to household soaps.

### **FLUOROCARBON PLASTICS**

5-42. Fluorocarbon plastics are used in all aircraft as insulation on wires in radios and other electronic equipment as corrosion-resistant coatings. They are chemically inert at ordinary temperatures but decompose at high temperatures. In aircraft, they pose a problem only when a fire occurs. At about 662 degrees Fahrenheit, fluorine gas is released. It reacts with moisture to form hydrogen fluoride, a highly corrosive acid. Above 700 degrees Fahrenheit, a small quantity of highly toxic perfluoroisobutylene is also released. Rapid, uncontrolled burning of fluorocarbon plastics yields more toxic products than does controlled thermal decomposition. If a fire occurs in an aircraft, aircrew members must wear oxygen masks to protect themselves against the fumes from fluorocarbon plastics. These agents are very irritating to the eyes, nose, and respiratory tract.

## OXYGEN CONTAMINATION

5-43. The experience of perceived oxygen contamination affects the performance of aircrews who routinely fly high-altitude profiles. Aviators have often reported objectionable odors in oxygen-breathing systems using compressed gaseous oxygen. While not present in toxic concentrations, these odors can produce nausea and perhaps vomiting. In situations other than accidental or gross contamination, the analysis of oxygen has indicated the presence of small amounts of a number of contaminants. These include water vapor, methane, carbon dioxide, acetylene, ethylene, nitrous oxide, and traces of hydrocarbons as well as unidentified contaminants. Complaints of oxygen-tank odors also have been attributed to the solvent trichlorethylene, which has, in the past, been used in cleaning the cylinders. The contaminants, either singly or in combination, never seem to reach concentration levels that are toxic to humans. Often the odors are neither offensive nor disagreeable, as indicated by such descriptive terms as stale, sweet, cool, fresh, pleasant, and unpleasant. Distinct symptoms that have been reported are headache, sickness, nausea, vomiting, and in some instances, disorientation. However, the usual problem with perceived oxygen contamination is most often psychological rather than physiological. During flight, aviators can become more concerned and apprehensive about their oxygen-breathing source. This preoccupation could lead to stress-induced hyperventilation or loss of situational awareness. If pilots are concerned about this issue, they should land as soon as practical to evaluate the oxygen equipment.

## PROTECTIVE MEASURES

5-44. Key points to remember from this chapter are—

- Be acutely aware of the potential toxic hazards in the aviation environment and the lethality associated with them at flight altitudes.
- In the working environment, use appropriate personal protective equipment to protect yourself from inhalation, absorption, and ingestion of toxic agents.
- Always work in well-ventilated areas when using toxic materials.
- Periodically analyze your own processes. If you perceive that they are not normal or if you have a strong urge to go to sleep or feel dizzy or unusual in any way, you may be experiencing the subtle onset of an incapacitating toxic exposure.
- Pay strict attention to physical symptoms such as a headache, burning eyes, choking, nausea, or reddened patches of skin, which may indicate a toxic exposure.
- Most importantly, remember that your immediate action measures—such as rapid ventilation of the cockpit, descending from high altitudes, or landing the aircraft as soon as possible and evacuating the aircraft—can alleviate a disaster.
- Last, even if you land safely but suspect that you have been exposed to a toxic hazard, consult your flight surgeon or another physician as soon as possible.

## Chapter 6

# Effects of Temperature Extremes on the Human Body

The human body is adapted to a narrow temperature range; it cannot function normally in hot and cold temperature extremes. Exposure to such extremes in the aviation environment impairs the efficiency of aircrews and adds to other stresses such as hypoxia and fatigue. Extreme climates can cause uncomfortable or unbearable cockpit conditions. Likewise, atmospheric temperature or altitude changes, aircraft interior ventilation and heating, and protective equipment can also create temperature extremes. This chapter briefly covers aviation operations in extreme climates; FM 3-04.202(1-202) contains an in-depth discussion of this subject.

## SECTION I – HEAT

### HEAT IN THE AVIATION ENVIRONMENT

#### HEAT EFFECTS

6-1. At times, aircrew members may have thought that the temperature inside their aircraft resembled that of a flying oven. Army aviation usually takes place at the relatively low altitudes that are associated with extremely high temperatures and humidity. Heat can seriously hamper mission requirements to accomplish complex tasks. In Army aviation, the potential for heat-stress problems is always present, not only because of unit locations but also because of Army aircraft construction.

#### KINETIC HEATING

6-2. During the flight, the aircraft structure is heated by friction between its surface and the air and by the rise in temperature caused by air compression in the front of the aircraft. Insulation in the cockpit and cabin air ductwork can reduce the effects of kinetic heating.

#### RADIANT HEATING

6-1. Solar radiant heat is the primary heat-stress problem in aircraft; the large expanses of glass or Plexiglas™ produce the greenhouse effect. This effect is caused by the differing transmission characteristics for radiation of differing wavelengths; thermal energy can become trapped within the cockpit. The temperatures in cockpits of aircraft parked on airfield ramps may be 50 to 60 degrees Fahrenheit higher than those in hangars because of the radiation of solar heating through transparent surfaces. This radiation, in turn, heats the interior objects of the cockpit. These heated objects then reradiate the waves at frequencies that cannot penetrate the glass or

Plexiglas™ outward. Therefore, heat accumulates within the cockpit and becomes a significant stress factor at altitudes below 10,000 feet.

## **ELECTRICAL HEAT LOADS AND COOLING SYSTEMS**

6-4. With the development of new high-performance aircraft, the electrical heat load in the cockpit increases as more and improved avionics equipment is fitted into these aircraft. The greater the temperature in the cockpit, the greater the possibility of degraded performance.

6-5. Comfortable limits in the cockpit are 68 to 72 degrees Fahrenheit and 25 to 50 percent relative humidity. To maintain these temperatures and this humidity range, aircraft must have extra heating and cooling equipment. This equipment is expensive in both performance and cost. (A rule of thumb is that one pound of extra load requires nine pounds of structure and fuel to fly it.)

## **HEAT TRANSFER**

### **TEMPERATURE REGULATION**

6-6. The body maintains its heat balance with several mechanisms. These are radiation, conduction, convection, and evaporation.

### **RADIATION**

6-7. Radiation involves the transfer of heat from an object of intense heat to an object of lower temperature through space by radiant energy. The rate of heat transfer depends mainly on the difference in temperature between the objects. If the temperature of the body is higher than the temperature of the surrounding objects, a greater quantity of heat is radiated away from the body than is radiated to the body.

### **CONDUCTION**

6-8. Conduction is the transfer of heat between objects, in contact at different temperatures, from heated molecules (body) to cooler molecules of adjacent objects. The proximity of these objects will determine the overall rate of conduction.

### **CONVECTION**

6-9. Convection is the transfer of heat from the body in liquids or gases in which molecules are free to move. During body-heat loss, the movement of air molecules is produced when the body heats the surrounding air; the heated air expands and rises because it is displaced by denser, cooler air. Respiration, which contributes to the regulation of body temperature, is a type of convection.

### **EVAPORATION**

6-10. Evaporative heat loss involves the changing of a substance from its liquid state (sweat) to its gaseous state. When water on the surface of the

body evaporates, heat is lost. Evaporation is the most common and usually the most easily explained form of heat loss.

## LIMITATIONS

6-11. Radiation, convection, and conduction all suffer one major disadvantage in cooling the body; they become less effective as temperature increases. When the temperature of the air and nearby objects exceeds skin temperature, the body actually gains heat. This gain may be dangerous to the aviator.

6-12. When the temperature increases to about 82 to 84 degrees Fahrenheit, sweat production increases abruptly to offset the loss of body cooling through radiation, convection, and conduction. By the time the temperature reaches 95 degrees Fahrenheit, sweat evaporation accounts for nearly all heat loss.

6-13. Many factors affect the evaporation process. Some of these factors are—

- Protective clothing.
- Availability of drinking water.
- Relative humidity above 50 percent.
- Environmental temperature above 82 degrees Fahrenheit.

6-14. Relative humidity is the factor that most limits evaporation; at a relative humidity of 100 percent, no heat is lost by this mechanism. Although the body continues to sweat, it loses only a tiny amount of heat. For example, a person can function all day at a temperature of 115 degrees Fahrenheit and a relative humidity of 10 percent if given enough water and salt. If the relative humidity rises to 80 percent at the same temperature, that same person may be incapacitated within 30 minutes.

## HEAT INJURY

6-15. The body will undergo certain physiological changes to counteract heat stress. To get heat from the inner body core to the surface where it can be lost to the surroundings, blood flow to the skin (cutaneous circulation) increases tremendously. Blood flow to other organs, such as the kidneys and liver, is reduced, and the heart rate is increased so that the body can maintain an adequate blood pressure. As the heat builds up, receptors in the skin, brain, and neuromuscular system are stimulated to increase sweat production. Normal heavy sweating produces one pint to one quart of sweat per hour; heat-stress conditions, however, can result in 3 to 4 quarts being produced. If a person does not replace this sweat loss by drinking liquids, the body rapidly dehydrates, the rate of sweat production drops, and the body temperature increases, causing further heat injury.

6-16. Individuals vary in their response to heat stress. Some serious reactions are heat cramps, heat exhaustion, and heatstroke. Factors that influence the physiological responses to heat stress include the amount of work that individuals perform and their physical condition as well as their ability to adapt to the environment. Old age, excessive alcohol ingestion, lack of sleep, obesity, or previous heatstroke can also diminish tolerance to heat stress. A previous episode of heatstroke can predispose an individual to repeated episodes.

## **PERFORMANCE IMPAIRMENT**

6-17. Heat stress not only causes general physiological changes but also results in performance impairment. Even a slight increase in body temperature impairs an individual's ability to perform complex tasks such as those required to fly an aircraft safely. A body temperature of 101 degrees Fahrenheit roughly doubles an aviator's error rate. Generally, increases in body temperature have the following effects on an aviator:

- Error rates increase.
- Short-term memory becomes less reliable.
- Perceptual and motor skills slow, and the capacity to perform aviation tasks decreases.

## **HEAT-STRESS PREVENTION**

6-18. By taking certain preventive measures, personnel can avoid heat stress. They can reduce their workload, replace lost water and salt, adapt to the environment, and wear protective clothing.

## **REPLACE WATER AND SALT LOSS**

6-19. The human body cannot adjust to a decreased intake of water. People must replace water that is lost through sweating to avoid heat injury. The body normally absorbs water at the rate of 1.2 to 1.5 quarts per hour. A reasonable limit for the total consumption for a 12-hour workday is from 12 to 15 quarts. Therefore, additional water intake is required. Individuals should drink one quart per hour for severe heat-stress conditions or one pint per hour for moderate stress conditions. Executing activities at night can minimize water loss.

6-20. Salt loss is high in personnel who either have not adapted to the environment or have adapted but are subjected to strenuous activity under heat stress. Replenishing this salt is important. Normally, adding a little more salt to food during preparation is enough to replenish the salt level. If larger amounts are required, the flight surgeon should be consulted.

## **ADAPT TO THE ENVIRONMENT**

6-21. Adaptation is essential to prevent heat injury. An individual who has not adapted to the environment is more susceptible to heat injury and disability; work performance will also decrease. A good plan of adaptation is based on a gradual increase in physical stress rather than a mere subjection of personnel to heat. A minimum of two weeks should be allowed for normal, healthy individuals to adapt; those who are less physically fit may require more time. Acclimation to heat can be attained in 4 to 5 days. Full heat acclimation takes from 7 to 14 days with two to three hours per day of carefully supervised exercise in the heat.

## **WEAR PROTECTIVE CLOTHING**

6-22. In direct sunlight, an individual should wear loose clothing for adequate ventilation and evaporative cooling. In a hot environment, clothing protects an individual from solar radiation but reduces the loss of body heat from

convection and conduction. Dark-colored clothing absorbs more radiant heat while light-colored clothing reflects it. To help reduce the heat load to the head, individuals should wear headgear to shade their head.

### **IN-FLIGHT HEAT-STRESS REDUCTION**

6-23. Army aircrew members are required to work in hot cockpits. Their ability to handle a particular situation depends on the specific aircraft and the problem. If aircrews will be exposed to the heat for a long time, the only alternative may be to terminate the mission to prevent their incapacitation. However, aborting the mission is a last resort. Aircrews can minimize in-flight heat stress by increasing ventilation and continuing to replace fluids.

### **INCREASE VENTILATION**

6-24. The pilot, more than any other crew member, must guard against heat stress. When speed and altitude permit, the pilot should open a window or canopy and direct the cool air entering the aircraft to his head and neck area to reduce heat buildup.

### **CONTINUE TO REPLACE FLUIDS**

6-25. Fluid intake during flight helps prevent dehydration and makes up for profuse sweating. Crew members should be encouraged to drink fluids as conditions permit, especially in anticipation of periods of physical exertion.

## **SECTION II – COLD**

### **COLD EFFECTS IN THE AVIATION ENVIRONMENT**

6-26. Although heat stress causes Army aircrew members the most significant problems, they cannot overlook the physiological effects of cold on the body. Because Army aircrews must operate in all types of environments, they must understand how the body reacts to cold-temperature extremes. For example, during World War II, the U.S. Army experienced 90,535 cases of cold injury, including several thousand cases of high-altitude frostbite in aircrews. During the Korean Conflict, there were 9,000 cases of cold injury, 8,000 of which occurred in the first winter (1951 to 1952).

6-27. Many factors influence the incidence of cold injury. If troops are in a static defensive position, the incidence of injury drops because they have time to take care of their bodies. Individuals under 17 or over 40 years of age seem to have a predisposition to suffer cold injury as do those who have previously suffered from it. Fatigue level, organizational discipline, individual training and experience, and physiological factors all affect the tendency of individuals to experience cold injury. Nutrition, activity, and the ingestion of certain drugs and medications also influence the incidence of cold injury.

## TYPES AND TREATMENT OF COLD INJURY

6-28. Hypothermia, trench foot (immersion foot), and frostbite are three types of cold injury that may affect aviators. A cold injury may be either superficial or deep.

6-29. Superficial cold injury usually can be detected by numbness, tingling, or pins-and-needles sensations. By acting on these signs and symptoms, individuals often can avoid further injury simply by loosening boots or other clothing and by exercising to improve circulation. In more serious cases involving deep cold injury, people may not be aware of a problem until the affected part feels like a stump or a block of wood.

6-30. Outward signs of cold injury include discoloration of the skin at the site of the injury. In light-skinned persons, the skin first reddens and then becomes pale or waxy white; in dark-skinned persons, the skin looks gray. An injured foot or hand feels cold to the touch. Swelling may also indicate deep injury. Soldiers should work in pairs—buddy teams—to check each other for signs of discoloration and other symptoms. Leaders should also be alert for signs of cold injuries.

6-31. First aid for cold injuries depends on whether the injury is superficial or deep. A superficial cold injury can be adequately treated by warming the affected part with body heat. This warming can be done by covering cheeks with hands, placing hands under armpits, or placing feet under the clothing of a buddy and next to his abdomen. The injured part should *not* be massaged, exposed to a fire or stove, rubbed with snow, slapped, chafed, or soaked in cold water. Individuals should avoid walking when they have cold-injured feet. Deep cold injury (frostbite) is very serious and requires more aggressive first aid to avoid or to minimize the loss of parts of the fingers, toes, hands, or feet. The sequence for treating cold injuries depends on whether the condition is life threatening. That is, removing the casualty from the cold is the *priority*. The other-than-cold injuries are treated at the same time as cold injuries while casualties are awaiting evacuation or are en route to a medical-treatment facility.

## COLD-INJURY PREVENTION

6-32. Some general measures can be taken to prevent all types of cold injury. Individuals can—

- Keep their body dry.
- Limit exposure to the cold.
- Avoid wearing wet clothing.
- Monitor the windchill factor.
- Keep activity below the perspiration level.
- Avoid the direct contact of bare skin and cold metal.
- Use the buddy system to check for early signs of cold injury.
- Wear several layers of loose-fitting clothing to increase insulation and cold-weather headgear to prevent loss of body heat.

- Avoid alcohol intake because it dilates surface blood vessels; this dilation initially causes the body to feel warmer but, because of heat loss, actually chills it.

6-33. The windchill chart in Table 6-1 gives the time limits for exposure to the cold before individuals experience injury. This chart correlates wind velocities and ambient air temperatures and shows the resulting temperatures from the windchill factor. The same data apply when wet boots or wet clothing is worn or flesh is exposed. This chart also indicates the level below which frostbite becomes a real hazard. Trench foot, or immersion foot, can occur at any temperature shown on the chart, given the right combination of wind velocity and ambient air temperature.

**Table 6-1. Windchill Temperatures**

ESTIMATED WIND SPEED		ACTUAL TEMPERATURE READING (°F)											
		50	40	30	20	10	0	-10	-20	-30	-40	-50	-60
(MPH) (KNOTS)		EQUIVALENT CHILL TEMPERATURE (°F)											
Calm	Calm	50	40	30	20	10	0	-10	-20	-30	-40	-50	-60
5	5.75	48	37	27	16	6	-5	-15	-26	-36	-47	-57	-68
10	11.75	40	28	16	4	-9	-24	-33	-46	-58	-70	-83	-95
15	17.25	36	22	9	-5	-18	-32	-45	-58	-72	-85	-99	-112
20	23.00	32	18	4	-10	-25	-39	-53	-67	-82	-96	-110	-121
25	28.75	30	16	0	-15	-29	-44	-59	-74	-88	-104	-118	-133
30	34.50	28	13	-2	-18	-33	-48	-63	-79	-94	-109	-125	-140
35	40.25	27	11	-4	-20	-35	-51	-67	-82	-98	-113	-129	-145
40	46.00	26	10	-6	-21	-37	-53	-69	-85	-100	-116	-132	-148
(Wind speeds greater than 40 MPH or 46 knots have little additional effect.)		LITTLE DANGER Exposed <i>dry</i> flesh is not likely to freeze in less than one hour; the maximum danger is a false sense of security.				INCREASING DANGER Exposed flesh may freeze within one minute.				GREAT DANGER Exposed flesh may freeze within 30 seconds.			
		(Trench foot, or immersion foot, may occur at any point on this chart.)											
NOTES: 1. This chart was developed by US Army Research of Institute of Environmental Medicine, Natick, MA. 2. To convert a Celsius temperature reading to a Fahrenheit temperature reading, use the following formula: $^{\circ}\text{F} = ^{\circ}\text{C} \times 9/5 + 32$ . 3. Measure or estimate the local temperature and wind speed. On this chart, find the temperature along the top and the wind speed along the left side. The intersection of the column and line gives the approximate equivalent chill temperature; for example, with a temperature of 20°F and a wind speed of 20 MPH (23 knots), the effect on exposed flesh is the same as a temperature of -10°F with no wind.													

## Chapter 7

# Noise and Vibration in Army Aviation

Aircraft, both rotary and fixed wing, produce perhaps the most severe noise and vibration environments experienced by aircrew members. These biomechanical force environments, singly and in combination, threaten the health, safety, and well-being of people associated with or exposed to aircraft operations. Mechanical vibration transmitted to human operators can induce fatigue, degrade comfort, interfere with performance effectiveness, and under severe conditions, influence operational safety and occupational health. Excessive exposure to airborne acoustic energy may interfere with routine living activities, induce annoyance, degrade voice communication, modify physiological functions, reduce the effectiveness of performance, and cause noise-induced hearing loss. Both noise and vibration effects may occur simultaneously with the initial exposure or may be manifested only after the passage of time and repeated exposure. The impact of most exposures can be minimized by focusing on the source, the propagation of the energy, and the exposed crew member. Monitoring the influence of such exposures over time with hearing tests and medical observations can also determine the impact of these combined factors. This chapter addresses the physiology of both noise and vibration and ways to minimize their short-term and long-term exposures. Aircrew members must use their knowledge and training to protect themselves and to prevent injuries caused by noise and vibration.

### NOISE CHARACTERISTICS AND EFFECTS

7-1. Noise is sound that is loud, unpleasant, or unwanted. Vibration is the motion of objects relative to a reference position, which is usually the object at rest. In aviation, both may cause annoyance, speech interference, fatigue, and hearing loss.

### ANNOYANCE

7-2. Noise energy is undesirable when attention is called to it unnecessarily or when it interferes with routine activities in the home or while flying an aircraft. Individuals become annoyed when the amount of interference becomes significant. High-frequency noises and vibration are especially irritating and can cause a subjective sense of fatigue.

### **SPEECH INTERFERENCE**

7-3. When noise and vibrations reach a certain loudness or amplitude, they mask normal speech communication. Thus, words become difficult to understand.

### **HEARING LOSS**

7-4. The most important and common undesirable effect of noise is permanent hearing damage. Excessive vibrations can manifest themselves in terms of internal organ malfunctions and skeletal disabilities. Damage may be rapid when noise is either extremely intense or prolonged. More often, it is insidious in onset and results from continual exposure at lesser intensities. All aviation personnel need to recognize that the damage may become permanent.

### **SOUND AND VIBRATIONAL MEASUREMENT**

7-5. Sound and vibration energy have measurable characteristics. These characteristics are frequency, intensity (or amplitude), and duration.

### **FREQUENCY**

7-6. Frequency is the physical characteristic that gives a sound the quality of pitch. Frequency of periodic motion is the number of times per second that the air pressure oscillates. The number of oscillations, or cycles per second, is measured in hertz.

### **Human Hearing and Speech Range**

7-7. The human ear is very sensitive and can detect frequencies from 20 to 20,000 hertz. Speech involves frequencies from 200 to 6,800 hertz, the range in which the ear is most sensitive.

### **Speech Intelligibility**

7-8. People must be able to hear in the range of 300 to 3,000 hertz to understand speech communication. Speech outside these ranges may result in incoherence or misinterpretation.

### **Vibration**

7-9. Vibration affects the body most in low frequencies, usually confined to frequency ranges below 100 hertz to displace body parts. These effects vary greatly with the direction, body support, and restraint.

### **INTENSITY/AMPLITUDE**

7-10. Intensity is a measure that correlates sound pressure to loudness. Amplitude (for vibration) is the maximum displacement about a position of rest.

7-11. Aviation personnel need to understand the relationship of decibels to sound pressure (vibration). For every 20-decibel increase in loudness, sound pressure increases by a factor of 10. At 80 decibels, sound pressure is 10-thousand times greater than at 0 decibel; at 100 decibels, sound pressure

is one-million times greater than at 0 decibel. The same sound pressure moving through the air that stimulates the ear to hear may also cause hearing loss under certain conditions. Table 7-1 shows the effects of various sound intensities on listeners.

**Table 7-1. Effects of Various Sound Intensities on the Listener**

Frequency (Db)	Effect
0	Threshold of Hearing
65	Average Human Conversation
85	Damage-Risk Limit
120	Threshold of Discomfort
140	Threshold of Pain
160	Eardrum Rupture

**DURATION**

7-12. Duration is the length of time that an individual is exposed to noise or vibrations. It is a variable factor that may be measured in seconds, minutes, hours, or days or any other selected unit of time.

**NATURAL BODY RESONANCE**

7-13. Natural body resonance is the mechanical amplification of vibration by the body occurring at specific frequencies. Table 7-2 shows resonant frequencies for various parts of the human body.

**Table 7-2. Resonant Frequencies for Various Parts of the Human Body**

Body Part	Resonant Frequency (Hz)
Whole Body	4-8
Shoulder Girdle	4-8
Head	25
Eyes	30-90

**DAMPING**

7-14. Damping is the loss of mechanical energy in a vibrating system. This loss causes the vibration to slow down.

**NOISE AND HEARING LEVELS**

7-15. Army aviation personnel are exposed to two types of sound levels that can impair their hearing. The sound levels that affect the duration of noise exposure are steady-state noise and impulse noise.

**STEADY-STATE NOISE**

7-16. Aviation personnel encounter this type of continuous noise around an operating aircraft. The noise is usually at a high intensity over a wide range of frequencies. The Surgeon General has established 85 decibels, at all

frequencies, as the maximum permissible sound level for continuous exposure to steady-state noise (damage-risk criteria). There is a direct link between duration of exposure and intensity; the louder the sound, the shorter the time required to cause hearing loss. Table 7-3 shows the recommended allowable sound intensities for the various durations of exposure. *Exposure to noise above recommended duration levels could result in noise-induced hearing loss*—the primary risk to Army aviators.

**Table 7-3. Recommended Allowable Noise-Exposure Levels**

Exposure Duration Per Day (hr)	Maximum Exposure Level (db)
8	85
4	90
2	95
1	100
1/2	105
<b>Note:</b> For every 5-decibel noise intensity increase, the exposure time limit is cut in half.	

## IMPULSE NOISE

7-17. Weapons fire produces this type of noise. It is an explosive sound that builds rapidly to a high intensity and then falls off rapidly. Although the entire cycle usually lasts only milliseconds, this sound is detrimental to hearing when the intensity exceeds 140 decibels.

7-18. Looking at Army aircraft as both fixed and rotary wing, certain generalizations can be made. Overall noise levels generally are equal to 100 or more decibels. This level exceeds the average 85-decibel damage-risk criteria. Table 7-4 shows the estimated noise levels for both rotary- and fixed-wing Army aircraft.

**Table 7-4. Rotary-Wing and Fixed-Wing Aircraft Noise Levels**

Aircraft	Noise Level (dB)
UH-1H	102
AH-1S	105
OH-58C	103
OH-58D	100
CH-47D	112
UH-60A	108
AH-64	104
TH-67*	102
C-12 / RC-12	106**
UC-35	96***
* Based on a Bell 206 helicopter	
** Exterior noise level,	
*** Cabin noise level	

7-19. The frequency that generates the most intense level is 300 hertz. Low-frequency noise will produce a high-frequency hearing loss. Providing adequate hearing protection for lower frequencies is very difficult. Exposures to these levels without hearing protection will cause permanent, noise-induced hearing loss.

## VIBRATIONAL EFFECTS

7-20. The human body reacts in various ways to vibration:

- Vibration can cause short-term acute effects because of the biomechanical properties of the body.
- The human body acts like a series of objects connected by springs.
- The connective tissue that binds the major organs together reacts to vibration in the same way as springs do.
- When the body is subjected to certain frequencies, the tissue and organs will begin to resonate (increase in amplitude).
- When objects reach their resonant frequencies, they create a momentum, which increases in intensity with each oscillation.
- Without shock absorption, vibration will damage the mass or organ.

7-21. Helicopters subject aircrew members to vibrations over a frequency range that coincides with the resonant frequencies of the body (Table 7-5). Prolonged contact with vibration causes short-term effects, as well as long-term effects, to the body. Minor amplitudes of the vibration and the ability of the body to provide some dampening are reasons why humans do not receive injuries every time they fly. Vibration can affect the respiratory system as well as cause—

- Motion sickness.
- Disorientation.
- Pain.
- Microcirculatory effects.
- Visual problems.

**Table 7-5. Vibration Frequency Levels for the UH-1 Helicopter**

Component	Frequency (Hz)
Engine	110
Main Rotor	4–11
Tail Rotor	30–60

## HEARING LOSS

7-22. Such factors as age, health, and the noise environment cause hearing loss. There are three types of hearing loss: conductive, presbycusis, and sensorineural.

## **CONDUCTIVE**

7-23. This type of hearing loss occurs when some defect or impediment blocks sound transmission from the external ear to the inner ear. Wax buildup, middle-ear fluid, and calcification of the ossicles can all impede the mechanical transmission of sound. A conductive hearing loss affects mainly the low frequencies. In most cases, this type of hearing loss can be treated medically. A hearing aid is often beneficial because the inner ear can still pick up sounds if they are loud enough. The aviator may fly with a hearing aid if he or she is given a waiver to continue on flight status.

## **PRESBYCUSIS**

7-24. This type of hearing loss usually results from old age. The hair cells of the cochlea become less resilient as people age.

## **SENSORINEURAL**

7-25. Sensorineural hearing loss occurs when the hair cells of the cochlea are damaged in the inner ear. The primary cause is noise exposure, but disease or aging also can cause this type of hearing loss. Sensorineural hearing loss caused by noise exposure usually occurs first in the higher frequencies. In some cases, a hearing aid may benefit, but generally, no known medical cure exists for this type of hearing loss.

## **MIXED**

7-26. A crew member may have an ear infection that could cause conductive hearing loss and have been diagnosed with a sensorineural hearing loss. The ear infection is treatable; sensorineural hearing loss is not.

## **HEARING PROTECTION AND REDUCTION OF VIBRATIONAL THREAT**

### **INDIVIDUAL RESPONSIBILITY**

7-27. Pilots, aircrew members, ground-support troops, and passengers should wear hearing protection at all times. Hearing loss is one hazard of the aviation environment that adequate protective measures can minimize.

7-28. The amount of sound protection that a protective device provides is determined by its fit and condition and, most importantly, by the willingness and ability of the individual to use it properly. Using individual devices in combination provides the best hearing protection.

7-29. While individual devices are not foolproof, virtually all noise-induced hearing loss is preventable if these devices fit properly and are worn on all flights. Even if hearing has already been affected somewhat, these devices will help prevent further damage. Hearing protection is ultimately each individual's responsibility.

## PROTECTIVE DEVICES

7-30. Aircraft noise levels interfere with the speech communication of Army aircrew members and pose the risk of hearing loss. Protective measures can reduce the undesirable effects of noise. These measures include—

- Use of personal protective measures.
- Isolation or distancing of crew members from the noise source.

## Helmets

7-31. The HGU-56P (Figure 7-1) and SPH-4B (Figure 7-2) aviator helmets are excellent means of personal protection from the standpoint of noise and crash attenuation. The helmets, designed primarily for noise protection, provide noise attenuation exceptionally well in the range of 3,000 to 8,800 hertz.

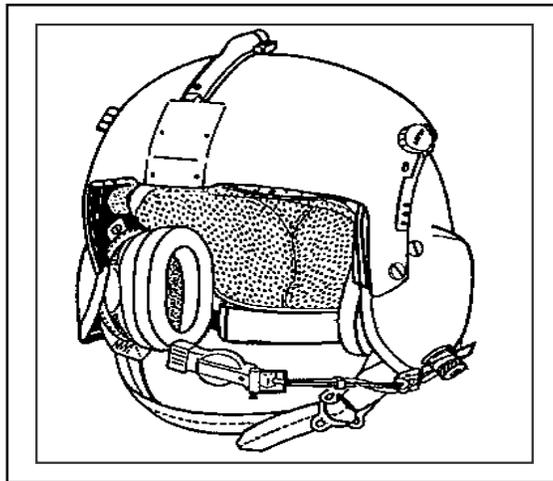

Figure 7-1. HGU-56P Helmet



Figure 7-2. SPH-4B Flight Helmet

7-32. When worn alone, the SPH-4B and the HGU-56P helmets reduce the noise exposure to safe limits for every aircraft in the Army inventory except for the UH-60 (Black Hawk) and CH-47 (Chinook). Table 7-6 shows the estimated attenuation levels for various types of helmets. The UH-60 and CH-47 aircraft require both helmet and earplug use to attenuate noise and prevent hearing loss.

7-33. Ancillary devices worn with the aviator's helmet can significantly compromise hearing protection. For example, eyeglass frames break the ear seal, creating a leak and producing a sound path from outside to inside the earcup.

**Table 7-6. Estimated Attenuation Levels for Helmets and Other Protective Devices**

<b>Aircraft</b>	<b>Hearing Protector</b>	<b>Effective Exposure Level (dB)</b>
<b>AH-1S</b>	HGU-56	77.0
	SPH-4B	77.4
	SPH-4	83.2
<b>UH-1H</b>	HGU-56	81.3
	SPH-4B	81.0
	SPH-4	85.9
<b>OH-58D</b>	HGU-56	81.6
	SPH-4B	81.5
	SPH-4	86.3
<b>OH-58C</b>	HGU-56	76.9
	SPH-4B	76.8
	SPH-4	81.4
<b>UH-60A</b>	HGU-56	90.6
	SPH-4B	90.6
	SPH-4	95.1
<b>CH-47D</b>	HGU-56	86.8
	SPH-4B	88.0
	SPH-4	93.4
<b>AH-64</b>	IHADSS (REG)	80.2
	IHADSS (XL)	83.5
<b>C-12</b>	H-157 Headset	70.5

### **Communications Earplug**

7-34. The communications earplug, Figure 7-3, improves hearing protection and speech-reception communication. The device includes a miniature transducer that reproduces speech signals from the internal communication

system. The foam tip acts as a hearing protector, similar to the yellow-foam earplugs that pilots wear for double hearing protection. A miniature wire from the CEP connects to the ICS through the mating connector mounted on the rear of the helmet. The CEP has recently been issued its AWR for all U.S. Army aircraft using the SPH-4B or HGU-56P helmets and for the M45 ACPM for all U.S. Army aircraft using the M24 mask. The tested pilot population has enthusiastically received this communication device. This product is not yet in the federal stock system. For more information on this product, contact the U.S. Army School of Aviation Medicine at DSN 558-7680.

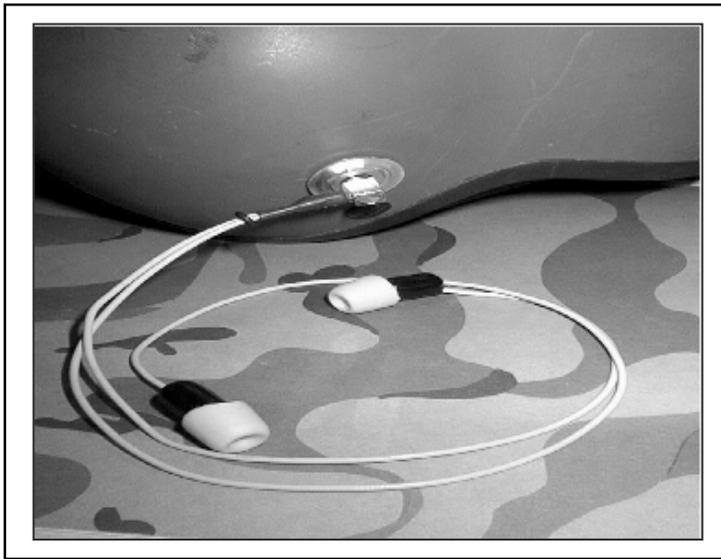

Figure 7-3. Communications Earplug

## Earplugs

**7-35. Insert-Type Earplugs.** Insert-type earplugs are among the most common types of hearing protection now in use. Earplugs need to be comfortable if they are to do their job. All earplugs tend to work loose because of talking or vibration and need to be resealed periodically to prevent inadvertent noise exposure. With properly fitted earplugs, users' voices will sound lower and muffled, as if they were talking inside a barrel. Noise protection with earplugs is 18 to 45 decibels across all frequency bands. Earplugs may come in three different types: the E-A-R® foam earplug, the V-51R single-flange earplug, and the SMR triple-flange earplug. Wearing earplugs for the first time in the cockpit may diminish the ability to hear communications in the cockpit. Crew members may feel that they have to concentrate and listen more closely to the transmissions. Once they get used to listening with the earplugs in place, crew members will find it easier to hear speech communication.

**7-36. E-A-R® Foam Earplug.** The E-A-R® yellow-foam earplug has three qualities: it excels in noise attenuation, comfort, and ease of maintaining a seal. To ensure maximum attenuation, these plugs should be kept clean and inserted properly.

7-37. **V-51R Single-Flange Earplug.** The V-51R single-flange earplug comes in five different sizes for better fit. Different sizes (extra small, small, medium, large, and extra large) provide a suitable fit for more than 95 percent of all Army aviation personnel. About 10 percent of aircrew members need a different size of earplug for each ear. The single-flange earplug may be cleaned with soap and water.

7-38. **SMR Triple-Flange Earplug.** The SMR provides about the same attenuation as the V-51R. Triple-flange earplugs come in three sizes (small, medium, and large). This earplug is comfortable for most individuals. This earplug may be cleaned with soap and water.

### Combined Hearing Protection

7-39. The polymeric foam (E-A-R®) hand-formed earplug—in combination with the SPH-4B, HGU-56, and IHADSS helmets—will provide additional protection from noise generated by *all* aircraft in the U.S. Army inventory. Table 7-7 shows exposure levels for various aircraft when the pilot wears the SPH-4 helmet with each of the three types of earplugs at the pilot's station.

**Table 7-7. Attenuation Levels for Protective Helmets and Earplugs**

Protector	UH-60A (120 knots)	CH-47D (100 knots)	AH-1S (100 knots)	OH-58 (100 knots)	UH-1H (100 knots)
SPH-4 with triple-flange plug	72.6	77.5	70.2	65.7	70.7
SPH-4 with single-flange plug	75.3	78.4	71.5	67.4	71.9
SPH-4 with foam plug	70.4	77.3	68.8	63.5	68.8
<b>Note:</b> SPH-4B helmet attenuation levels when worn with earplugs are 1 to 2 decibels lower for each aircraft indicated above. HGU-56 helmet attenuation levels when worn with earplugs are 2 to 3 decibels lower for each aircraft indicated above.					

### Earmuffs

7-40. Several types of earmuffs (Figure 7-4) provide adequate sound protection for ground-support aviation personnel. Most earmuffs that are in good condition and properly adjusted will attenuate sound as well as properly fitted earplugs. The earmuffs tend to give slightly more high-frequency protection and slightly less low-frequency protection than earplugs.

## PREVENTIVE MEASURES

7-41. Vibration cannot be eliminated, but its effects on human performance and physiological functions can be lessened. Various preventive measures can be taken to reduce the effects of vibration:



**Figure 7-4. Earmuff**

- Maintain good posture during flight. Sitting straight in the seat will enhance blood flow throughout the body.
- Restraint systems provide protection against high-magnitude vibration experienced in extreme turbulence.

### **CAUTION**

Body supports, such as lumbar inserts and added seat cushions, reduce discomfort and can dampen vibration; however, during a crash sequence they may increase the likelihood of injury because of their compression characteristics. Do not modify the aircraft seats for the sake of comfort.

- Maintain your equipment. Proper aircraft maintenance, such as blade tracking, can reduce unnecessary vibration exposure.
- Isolate the aircrew members or passengers. When loading patients on MEDEVAC aircraft, remember that patients placed on the floor will experience more vibration than those in the upper racks.
- Limit your exposure time. Make short flights with frequent breaks, rather than one long flight, if the mission permits.
- Let the aircraft do the work. Do not grip the controls tightly. Vibration can be transmitted through control linkages during turbulence.
- Maintain excellent physical condition. Fat multiplies vibration while muscle dampens vibration. Strong muscles act to reduce the magnitude of oscillations encountered in flight (damping). An overweight aircrew member is more susceptible to decrements in performance and the physiological effects of vibration.
- Maintain good physical condition to lessen the effects of fatigue. Being in good physical condition permits you to continue to function during

extended combat operations with minimum rest. Energy and alertness keep you alive.

- Maintain sufficient hydration. Drink plenty of fluids, even if you do not feel thirsty: a minimum of two quarts of water in addition to fluids taken with meals. Dehydration, coupled with vibration, can cause fatigue twice as fast and double the time needed for recovery.

## Chapter 8

# Principles and Problems of Vision

Aircrew members rely more on the visual sense than any other sense to orient themselves in flight. The following visual factors contribute to aviation performance: good depth perception for safe landings, good visual acuity to identify terrain features and obstacles in the flight path, and good color vision. Although vision is the most accurate and reliable sense, visual cues can be misleading, contributing to incidents occurring within the flight environment. Aviation personnel must be aware of and know how to compensate effectively for the following: physical deficiency or self-imposed stress, such as smoking, which limits night-vision capability; visual-cue deficiencies; visual limitations, consisting of degraded visual acuity, dark adaptation, and color and depth perception. For example, at night, the unaided eye has degraded visual acuity. To complete the mission safely, aircrew members must learn and effectively apply proper night-vision viewing techniques to compensate for this limitation.

### VISUAL DEFICIENCIES

8-1. One contributing factor associated in achieving safe and successful flights is that aviation personnel must be able to recognize and understand common visual deficiencies. Important eye problems related to degraded visual acuity and depth perception include myopia, hyperopia, astigmatism, presbyopia, and retinal rivalry. Surgical procedures to sculpt or reshape the cornea may also result in visual deficiencies.

#### MYOPIA

8-2. This condition, often referred to as nearsightedness, is caused by an error in refraction in which the lens of the eye does not focus an image directly on the retina. When a myopic person views an image at a distance, the actual focal point of the eye is in front of the retinal plane (wall), causing blurred vision. Thus, distant objects are not seen clearly; only nearby objects are in focus. Figure 8-1 depicts this condition.

#### NIGHT MYOPIA

8-3. At night, blue wavelengths of light prevail in the visible portion of the spectrum. Therefore, slightly nearsighted (myopic) individuals viewing blue-green light at night may experience blurred vision. Even aircrew members with perfect vision will find that image sharpness decreases as pupil diameter increases. For individuals with mild refractive errors, these factors combine to make vision unacceptably blurred unless they wear corrective glasses.

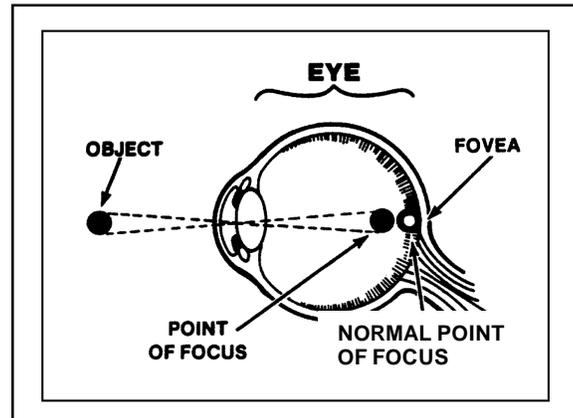

Figure 8-1. Myopia (Nearsightedness)

8-4. Another factor to consider is “dark focus.” When light levels decrease, the focusing mechanism of the eye may move toward a resting position and make the eye more myopic. These factors become important when aircrew members rely on terrain features during unaided night flights. Special corrective lenses can be prescribed to correct for night myopia.

## HYPEROPIA

8-5. Hyperopia is also caused by an error in refraction—the lens of the eye does not focus an image directly on the retina. In a hyperopic state, when an aircrew member views a near image, the actual focal point of the eye is behind the retinal plane (wall), causing blurred vision. Objects that are nearby are not seen clearly; only more distant objects are in focus. This problem, referred to as farsightedness, is shown in Figure 8-2.

## ASTIGMATISM

8-6. An unequal curvature of the cornea or lens of the eye causes this condition. A ray of light is spread over a diffuse area in one meridian. In normal vision, a ray of light is sharply focused on the retina. Astigmatism is the inability to focus different meridians simultaneously. If, for example, astigmatic individuals focus on power poles (vertical), the wires (horizontal) will be out of focus for most of them, as shown in Figure 8-3.

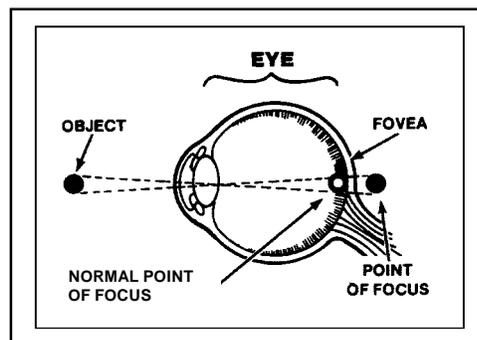

Figure 8-2. Hyperopia (Farsightedness)

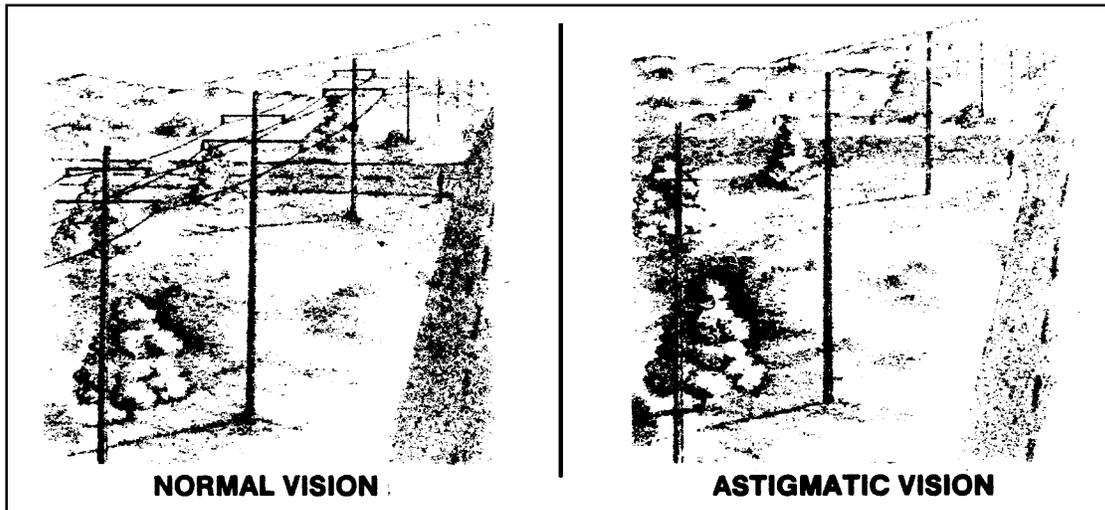

Figure 8-3. Astigmatism

## PRESBYOPIA

8-7. This condition is part of the normal aging process, which causes the lens to harden. Beginning in their early teens, the human eye gradually loses the ability to accommodate for and focus on nearby objects. When people are about 40 years old, their eyes are unable to focus at normal reading distances without reading glasses. Reduced illumination interferes with focus depth and accommodation ability. Hardening of the lens may also result in clouding of the lens (cataract formation). Aviators with early cataracts may see a standard eye chart clearly under normal daylight but have difficulty seeing under bright light conditions. This problem is due to the light scattering as it enters the eye. This glare sensitivity is disabling under certain circumstances. Glare disability, related to contrast sensitivity, is the ability to detect objects against varying shades of backgrounds. Other visual functions decline with age and affect the aircrew member's performance:

- Dynamic acuity.
- Recovery from glare.
- Function under low illumination.
- Information processing.

## RETINAL RIVALRY

8-8. Eyes may experience this problem when attempting to simultaneously perceive two dissimilar objects independently. This phenomenon may occur when pilots view objects through the heads-up display in the AH-64 Apache. If one eye views one image while the other eye views another, conflict arises in total perception. Quite often, the dominant eye will override the nondominant eye, possibly causing the information delivered to the nondominant eye to be missed. Additionally, this rivalry may lead to ciliary spasms and eye pain. Mental conditioning and practice appear to alleviate this condition; therefore, retinal rivalry becomes less of a problem as aircrew members gain experience.

---

## **SURGICAL PROCEDURES**

### **Radial Keratotomy**

8-9. Radial keratotomy is a surgical procedure that creates multiple radial, lased, spokelike incisions through the use of an argon laser upon the cornea of the eye to improve visual acuity. Radial keratotomy permanently disqualifies an individual from flight for Army aviation. The resulting glare sensitivity (sparkling effect throughout the viewing field) and tissue scarring contribute to flight disqualification.

### **Photorefractive Keratectomy**

8-10. PRK is a procedure to correct corneal refractive errors by use of a laser. The laser has replaced the scalpel in surgical correction of myopia. PRK ablates or reshapes the central cornea. The effects of this procedure flatten the cornea, which bends or refracts the light properly on the retina, correcting the myopic deficiency. This procedure is currently being considered for approval but, at this time, like radial keratotomy, permanently disqualifies an individual from flight duty for Army aviation. Irregularity of the cornea surface causes astigmatism, the most common cause of disqualification.

### **LASIK or Keratomileusis**

8-11. LASIK is the procedure used to carve and reshape the cornea. Surgeons use a laser to shave the anterior half of the cornea, creating a flap. The flap is retracted, and the inner side of the cornea is reshaped with a laser, causing the cornea to flatten. When the reshaping is completed, the flap is replaced in its original position and sutured (sewn) back into place, similar to a Band-Aid® effect. The flatter cornea now bends or refracts the light properly on the retina. Unlike radial keratotomy or PRK, this technique can correct for severe myopia and hyperopia. The main adverse effect is irregularity of the corneal surface, causing astigmatism. In addition, if the flap of an individual who has undergone this procedure became suddenly unattached in an accident, the result would be a permanent defect to the cornea and severely degraded visual acuity. This procedure permanently disqualifies the aircrew member from flight duty for Army aviation.

8-12. Various surgical procedures are available to correct visual deficiencies; not all are listed. The procedures described above are currently the most common. AR 40-501 and AR 95-1 state that all corrective eye surgeries involving LASIK or PRK or other forms of corrective eye surgery disqualify Army aircrew members from flight duty. Aircrew members must consult their flight surgeons before undergoing these procedures.

## **ANATOMY AND PHYSIOLOGY OF THE EYE**

8-13. Aircrew members are required to understand basic anatomy and physiology of the eye if they are to use their eyes effectively during flight. Figure 8-4 shows the basic anatomy of the human eye.

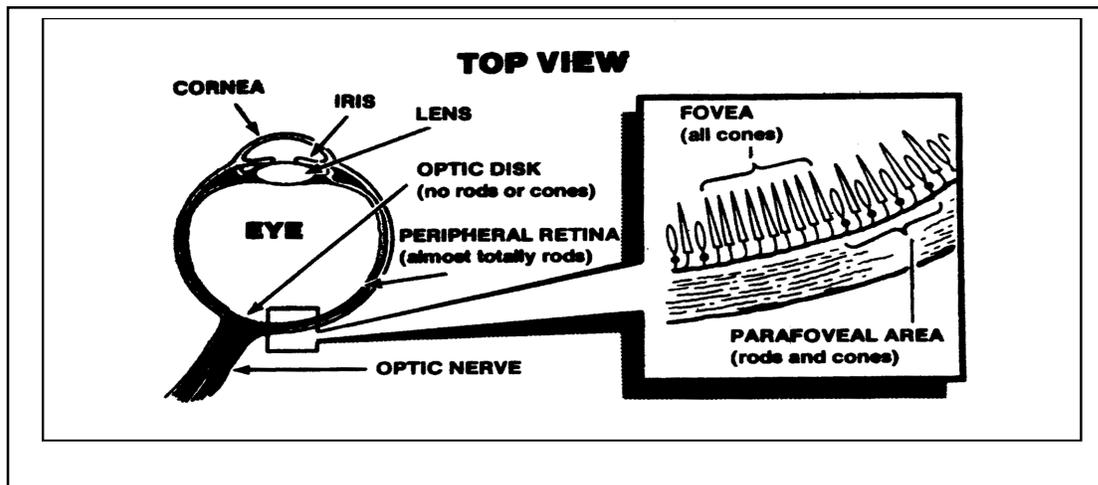

Figure 8-4. Anatomy of the Eye

## VISUAL ACUITY

8-14. Visual acuity measures the eye's ability to resolve spatial detail. The Snellen visual acuity test is commonly used to measure an individual's visual acuity. The Snellen test expresses the comparison of the distance at which a given set of letters is correctly read to the distance at which the letters would be read by someone with clinically normal eyesight. Normal visual acuity is 20/20. A value of 20/80 indicates that an individual reads at 20 feet the letters that an individual with normal acuity (20/20) reads at 80 feet away. The human eye functions like a camera. It has an instantaneous field of view, which is oval and typically measures 120 degrees vertically by 150 degrees horizontally. When two eyes are used for viewing, the overall FOV measures about 120 degrees vertically by 200 degrees horizontally.

## ANATOMY AND PHYSIOLOGY

8-15. When light from an object enters the eye, it passes through the cornea. The cornea is a circular, transparent protective tissue that projects forward and protects the eye. Once light travels through the cornea, it enters the pupil. The pupil is the opening (black center portion) in the center of the iris. The pupil allows the light to enter the eye to stimulate the retina. The iris is the round, pigmented (colored) membrane of the eye surrounding the pupil. For example, for people with brown, green, or hazel eyes, that colored portion is the iris. The iris adjusts the size of the pupil by using its ciliary muscles, which are attached to the pupil. The iris adjusts the size of the pupil to regulate the amount of light entering the eye. When the pupil dilates (enlarges) under low light levels, it allows more light to enter the eye to further stimulate the retina. When the pupil constricts (becomes smaller) under high light levels, it decreases the amount of light entering the eye, avoiding oversaturation (stimulation) of the retina. Light entering the eye is regulated so that the retina is not undersaturated or oversaturated with light images, which would negatively affect visual acuity. Once the light travels through the pupil, it will strike the lens. The lens is a transparent, biconvex

membrane located behind the pupil. The lens then directs (refracts) the light upon the retina (the posterior or rear portion of the eye). The retina is a complex, structured membrane, consisting of 10 layers called the Jacob's membrane. The retina contains many tiny photoreceptor cells, called rods and cones. Once light stimulates the retina, it produces a chemical change within the photoreceptor cells. When the chemical change occurs, nerve impulses are stimulated and transmitted to the brain via the optic nerve. The brain deciphers the impulse and creates a mental image that interprets what the individual is viewing.

### RETINAL PHOTORECEPTOR CELLS

**8-16. Rods and Cones.** The retinal rod and cone cells are so named because of their shape. The cone cells are used principally for day or high-intensity light vision (viewing periods or conditions). The rods are used for night or low-intensity light vision (viewing periods or conditions). Some of the characteristics of day and night vision are due to the distribution pattern of rods and cones on the retina. The center of the retina, the fovea, contains a very high concentration of cone cells but no rod cells. The concentration of rod cells begins to increase toward the periphery of the retina.

**8-17. Cone Neurology.** The retina contains seven million cone cells. Each cone cell in the fovea is connected to a single nerve fiber that leads directly to the brain. This single-nerve connection of each foveal cone to the brain means that each cone generates a nerve impulse under sufficient light levels. This occurs during daylight or viewing conditions of high-intensity light exposure. Cone cells provide sharp visual acuity and the perception of color. When crew members view under low light or dark conditions, cone cells depict shades of black, gray, and white; crew members will perceive other colors if the light intensity is heightened by artificial light sources:

- Aircraft position lights.
- Anticollision lights.
- Runway lights.
- Beacon lights.
- Artificial lighting related to metropolitan areas.

**8-18. Rod Neurology.** There are 120 million rod cells in the retina. Rod cells have a 10-to-1, up to a 10,000-to-1, ratio of rod cells to neuron cells within the retina. Because of the large number of rod cells that are connected to each nerve fiber outside of the fovea, dim light can trigger a nerve impulse to the brain. The periphery of the retina, where the rods are concentrated, is much more sensitive to light than is the fovea. This concentration of rods is responsible for night vision (peripheral vision), which provides for silhouette recognition of objects. This is also why aircrew members' eyes are highly sensitive to light when viewing during low ambient light or dark conditions.

### IODOPSIN AND RHODOPSIN

**8-19.** Vision is possible because of chemical reactions within the eye. The chemical iodopsin is always present within the cone cells. Iodopsin permits the cone cells to respond immediately to visual stimulation, regardless of the

level of ambient light. However, rod cells contain an extremely light-sensitive chemical called rhodopsin, more commonly referred to as visual purple. Rhodopsin is not always present in the rods because light bleaches it out and renders the rods inactive to stimulation. So sensitive is rhodopsin that bright-light exposure can bleach out all visual purple within seconds.

### Night Vision

8-20. For night vision to take place, rhodopsin must build up in the rods. The average time required to gain the greatest sensitivity is 30 to 45 minutes in a dark environment. When fully sensitized (dark adapted), the rod cells may become up to 10,000 times more sensitive than at the start of the dark adaptation period. Through a dilated pupil, total light sensitivity may increase 100,000 times.

### Day Blind Spot

8-21. Because humans have two eyes and view all images with binocular vision, each eye compensates for the day blind spot in the optic disk of the opposite eye. The day blind spot covers an area of 5.5 to 7.5 degrees. It is located about 15 degrees from the fovea and originates where the optic nerve attaches to the retina. The size of the day blind spot is due to the oval shape of the optic nerve combined with its offset position where it attaches to the retina by the 5.5 to 7.5 degrees. Where the optic nerve attaches to the retina, no photoreceptor cells (cones or rods) are present. The day blind spot only causes difficulty when individuals do not move their head or eyes but continue to look straightforward while an object is being brought into the visual field. Figure 8-5 demonstrates the presence of the day blind spot.

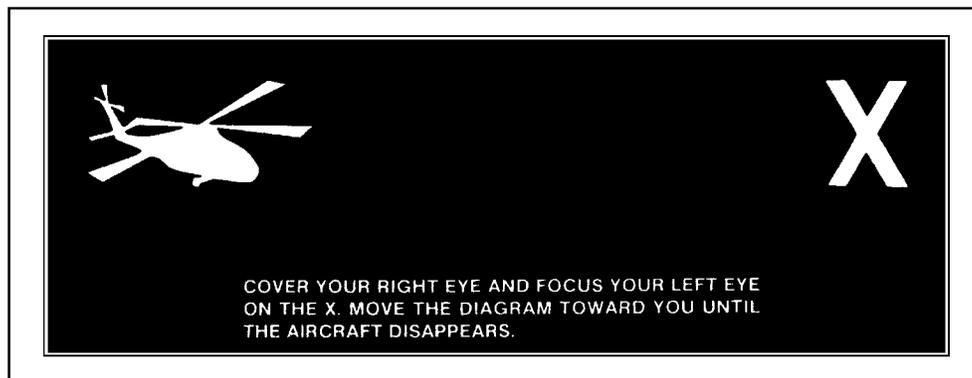

Figure 8-5. Demonstration of the Day Blind Spot

## TYPES OF VISION

8-22. The three types of vision (viewing periods) associated with Army aviation are photopic, mesopic, and scotopic. Each type (viewing period) requires different sensory stimuli or ambient light conditions.

## PHOTOPIC VISION

8-23. Photopic vision, shown in Figure 8-6, is experienced during daylight or under high levels of artificial illumination. The cones concentrated in the fovea centralis are primarily responsible for vision in bright light. Because of the high-level light condition, rod cells are bleached out and become less effective. Sharp image interpretation and color vision are characteristics of photopic vision. The fovea centralis is automatically directed toward an object by a visual fixation reflex. Therefore, under photopic conditions, the eye uses central vision for interpretation, especially for determining details.

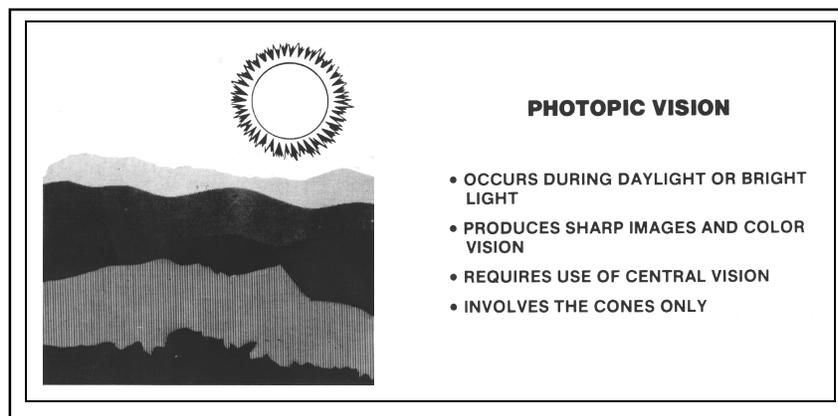

Figure 8-6. Photopic Vision

## MESOPIC VISION

8-24. Mesopic vision, shown in Figure 8-7, is experienced at dawn and dusk and under full moonlight. Vision is achieved by a combination of rods and cones. Visual acuity steadily decreases with declining light. Color vision is reduced (degraded) as the light level decreases, and the cones become less effective. Mesopic vision (viewing period) is the most dangerous of all three types of vision for aircrew members. How degraded the ambient light condition is during this type of vision will determine what type of scanning (viewing) technique that aircrew members should use to detect objects and maintain a safe and incident-free flight. For example, with the gradual loss of cone sensitivity, off-center viewing may be necessary to detect objects in and around the flight path. If aircrew members fail to recognize the need to change scanning techniques from central or focal viewing to off-center viewing, incidents may occur.

## SCOTOPIC VISION

8-25. Scotopic vision, shown in Figure 8-8, is experienced under low-light level environments such as partial moonlight and starlight conditions. Cones become ineffective, causing poor resolution of detail. Visual acuity decreases to 20/200 or less, and color perception is lost. A central blind spot (night blind spot) occurs when cone-cell sensitivity is lost. Primary color perception during scotopic vision is shades of black, gray, and white unless the light source is high enough in intensity to stimulate the cones. Peripheral vision is primary for viewing with scotopic vision.

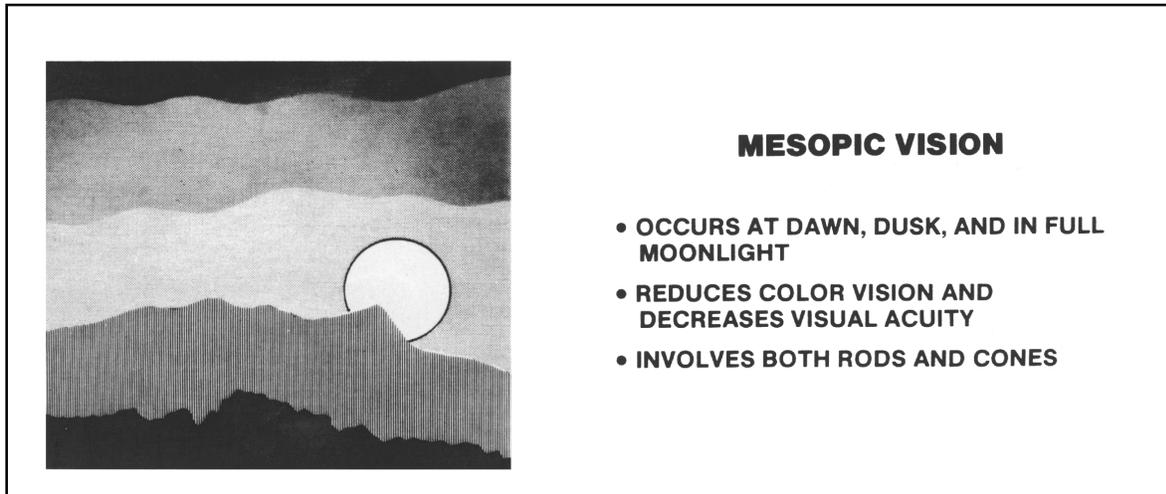

Figure 8-7. Mesopic Vision

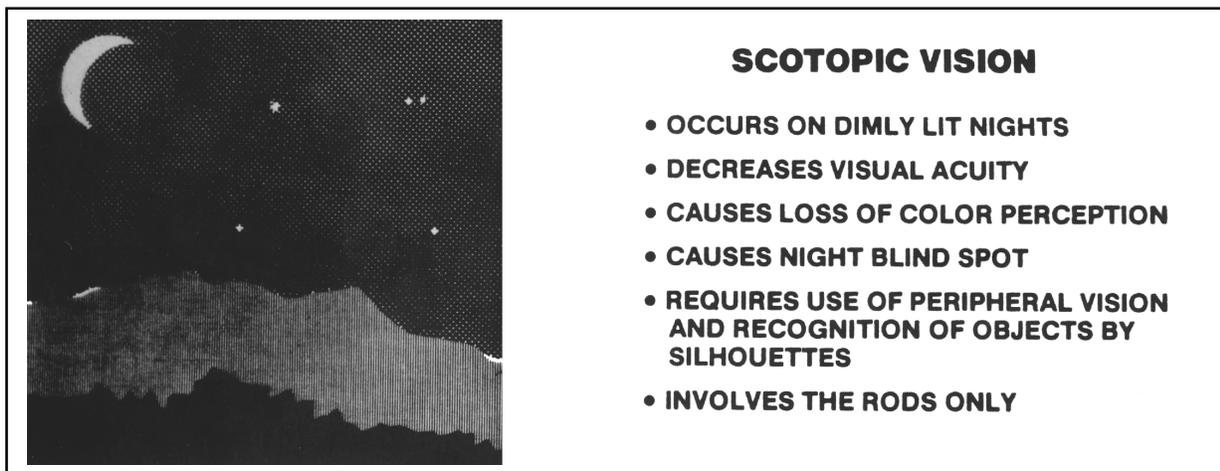

Figure 8-8. Scotopic Vision

### Night Blind Spot

8-26. The night blind spot, shown in Figure 8-9, should not be confused with the day blind spot. The night blind spot occurs when the fovea becomes inactive under low-level light conditions. The night blind spot involves an area from 5 to 10 degrees wide in the center of the visual field. If an object is viewed directly at night, it may not be seen because of the night blind spot; if the object is detected, it will fade away when stared at for longer than two seconds. The size of the night blind spot increases as the distance between the eyes and the object increases. Therefore, the night blind spot can hide larger objects as the distance between the observer and the object increases. Figure 8-10 shows this effect.

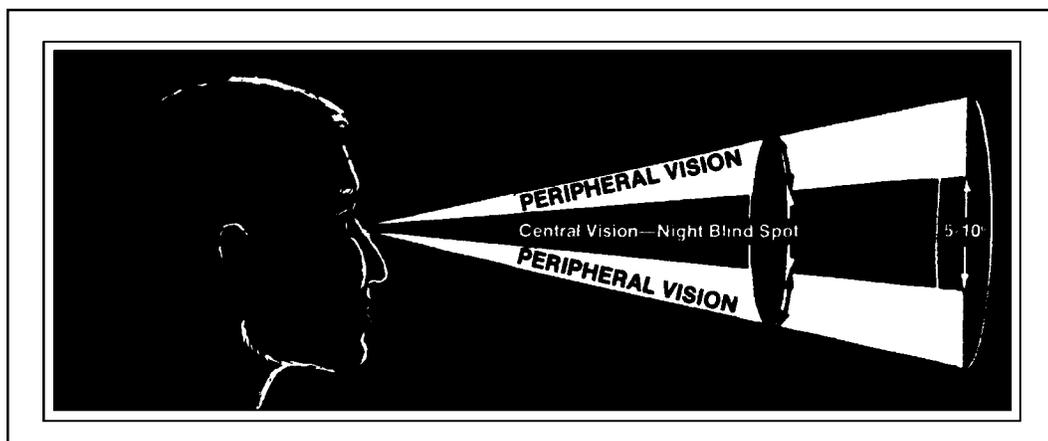

Figure 8-9. Night Blind Spot

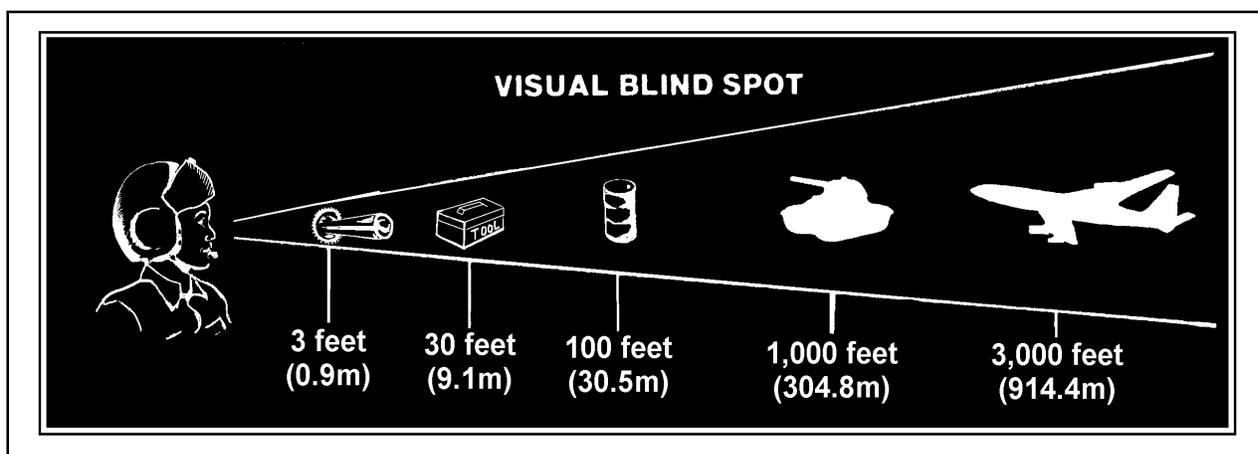

Figure 8-10. Effects of the Night Blind Spot

### Peripheral Vision

8-27. Stimulation of only rod cells (peripheral vision) is primary for viewing during scotopic vision. Aircrew members must use peripheral vision to overcome the effects of scotopic vision. Peripheral vision enables aircrew members to see dimly lit objects and maintain visual reference to moving objects. The natural reflex of looking directly at an object must be reoriented through night-vision training. To compensate for scotopic vision, aircrew members must use searching eye movements to locate an object and small eye movements to retain sight of the object. Aircrew members must use off-center viewing. Characteristically, if the eyes are held stationary when focusing on an object for more than two to three seconds using scotopic vision, an image may fade away (bleach out) completely.

## FACTORS AFFECTING OBJECT VISIBILITY

8-28. The ease with which an object can be seen depends on various factors. Each factor can either increase or decrease the visibility of an object. The visibility of an object increases as the—

- Angular size of the object increases as the distance between the object and the viewer decreases.
- Illumination (overall brightness) of ambient light increases.
- Degree of retinal adaptation increases.
- Color and contrast between the target and background increase.
- Position of the target within the visual field (visibility threshold) increases.
- The focus of the eye and length of time viewing the object increase.
- Atmospheric clarity increases. ND-15 sunglasses can aid visibility during viewing conditions of excessive light or brightness.

8-29. As aircraft speed increases, there is interference in the perception of instantaneous visual pictures. In some cases, it may take one to two seconds or longer to recognize and consciously assess a complex situation. By the time that an object is eventually perceived, it may have already been overtaken. The time that it takes to perceive an object becomes significant to the aircrew member. Perception time includes the time that it takes—

- The message indicating that an image of an object has been identified within the visual field and that image information travels from the eye to the brain to include the time it takes the brain to receive, comprehend, and identify the information.
- The eye to turn toward and focus on the unknown object.
- An individual to recognize the object and determine its importance.
- To transmit a decision to move muscles and cause the aircraft to respond to control inputs.

## DARK ADAPTATION

8-30. Dark adaptation is the process by which the eyes increase their sensitivity to low levels of illumination. Rhodopsin (visual purple) is the substance in the rods responsible for light sensitivity. The degree of dark adaptation increases as the amount of visual purple in the rods increases through biochemical reaction. Each person adapts to darkness in varying degrees and at different rates. For example, for the person viewing in a darkened movie theater, the eye adapts quickly to the prevailing level of illumination. However, compared to the light level of a moonless night, the light level within the movie theater is high. Another example is that a person requires less time to adapt to complete darkness after viewing in a darkened theater than after viewing in a lighted hangar, the lower the starting level of illumination, the less time is required for adaptation.

8-31. Dark adaptation for optimal night-vision acuity approaches its maximum level in about 30 to 45 minutes under minimal lighting conditions.

If the eyes are exposed to a bright light after dark adaptation, their sensitivity is temporarily impaired. The degree of impairment depends on the intensity and duration of the exposure. Brief flashes from high-intensity, white (xenon) strobe lights, which are commonly used as anticollision lights on aircraft, have little effect on night vision. This is true because the energy pulses are of such short duration (milliseconds). Exposure to a flare or a searchlight longer than one second can seriously impair night vision. Depending on the brightness (intensity), duration of exposure, or repeated exposures, an aircrew member's recovery time to regain complete dark adaptation could take from several minutes to the full 45 minutes or longer.

8-32. Exposure to bright sunlight also has a cumulative and adverse effect on dark adaptation. Reflective surfaces—such as sand, snow, water, or man-made structures—intensify this condition. Exposure to intense sunlight for two to five hours decreases visual sensitivity for up to five hours. In addition, the rate of dark adaptation and the degree of night visual acuity decrease. These cumulative effects may persist for several days.

8-33. The retinal rods are least affected by the wavelength of a dim red light. Figure 8-11 compares rod and cone cell sensitivities. Because rods are stimulated by low ambient light levels, red lights do not significantly impair night vision if the proper techniques are used. To minimize the adverse effect of red lights on night vision, crew members should adjust the light intensity to the lowest usable level and view instruments for only a short time.

8-34. Illness also adversely affects dark adaptation. A fever and a feeling of unpleasantness are normally associated with illness. High body temperatures consume oxygen at a higher-than-normal rate. This oxygen depletion may induce hypoxia and degrade night vision. In addition, the unpleasant feeling that is associated with sickness is distracting and may restrict the aircrew member's ability to concentrate on flight duties and responsibilities.

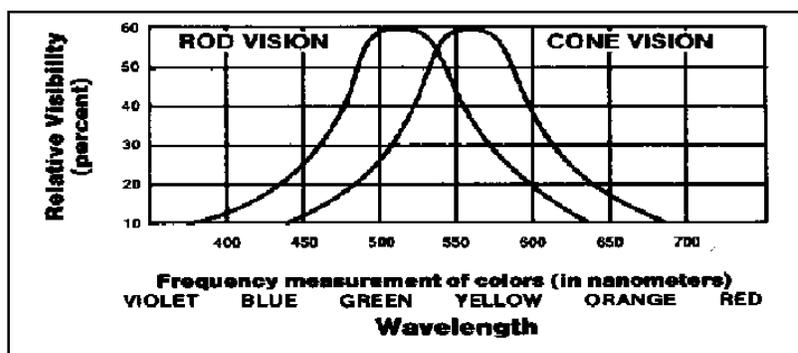

Figure 8-11. Photopic (Cone) and Scotopic (Rod) Sensitivity to Various Colors

## NIGHT-VISION PROTECTION

8-35. Aircrew members should attain maximum dark adaptation in the minimal possible time. In addition, aircrew members must protect themselves against the loss of night vision. There are several methods for accomplishing these requirements.

## **PROTECTIVE EQUIPMENT**

### **Sunglasses**

8-36. When exposed to bright sunlight for prolonged periods, aircrew members should wear military-issued, neutral-density sunglasses (ND-15) or equivalent filter lenses when anticipating a night flight. This precaution minimizes the negative effects of sunlight (solar glare) on rhodopsin production, which maximizes the rate of dark adaptation and improves night vision sensitivity and acuity.

### **Red-Lens Goggles**

8-37. Aircrew members, if possible, should wear approved red-lens goggles or view under red lighting before executing night-flying operations to achieve complete dark adaptation. This procedure allows aircrew members to begin dark adaptation in an artificially illuminated room before flight. Red lighting and red-lens goggles do not significantly interfere with the production of rhodopsin to stimulate the effectiveness of the rods for night vision. Red lighting and red-lens goggles decrease the possibility of undesirable effects from accidental exposure to bright lights; this is especially true when aviators are going from the briefing room to the flight line. Exposure to a bright-light source, however, lengthens the time for aircrew members wearing red-lens goggles to achieve dark adaptation. If the light source is high enough in intensity and duration of exposure is prolonged when viewing with red-lens goggles, aircrew members will not achieve complete dark adaptation. Red-lens goggles or red illumination does reduce dark adaptation time and may preserve up to 90 percent of the dark adaptation in both eyes. Aircrew members will not use red lighting or red-lens goggles when viewing inside or outside of the aircraft during flight. Red lighting is a longer nanometer, which is very fatiguing to the eyes. In addition, for aircrew members viewing under red lighting, the reds and browns found on nontactical maps not constructed for red-light use will bleach out.

### **Supplemental Oxygen Equipment**

8-38. When flying at or above 4,000 feet pressure altitude, aircrews should use pressure-altitude supplemental oxygen if available. Adverse effects upon night vision set in at 4,000 feet pressure altitude. Effective night vision depends on the optimal function and sensitivity of the retinal rods. Lack of oxygen (hypoxia) significantly reduces rod sensitivity, increases the time required for dark adaptation, and decreases night vision. AR 95-1 describes the requirements of supplemental oxygen use related to pressure altitudes.

## **PROTECTIVE MEASURES**

### **Cockpit Light Adjustment**

8-39. Instrument, cockpit, and rear cargo area overhead lights (if applicable) should be adjusted to the lowest readable level that allows instruments, charts, and maps to be interpreted without prolonged staring or exposure. Although blue-green lighting at low intensities can also be used in cockpits without significantly disrupting unaided night vision and dark adaptation, items printed in blue-green may wash out. The use of blue-green lighting,

however, has several benefits. Blue-green light falls naturally on the retinal wall and allows the eye to focus easily on maps, approach plates, and instruments; blue-green lighting results in less eye fatigue. In addition, the intensity necessary for blue-green lighting is less than that for red lighting and results in a decreased infrared signature as well as less glare. When blue-green lighting is used properly, the decrease in light intensity and the ease of focusing make it more effective for night vision.

### **Exterior Light Adjustment**

8-40. Exterior lights should be dimmed or turned off if possible and the mission permits. Aviators should consult command policy for local procedures.

### **Light-Flash Compensation**

8-41. Pilots should turn the aircraft away from the light source if a flash of high-intensity light is expected from a specific direction. The aircraft should also be maneuvered away from flares. When flares are illuminating the viewing area or are inadvertently ignited nearby, the pilot should maneuver to a position along the periphery of the illuminated area. The aircraft should be turned so that vision is directed away from the light source. This procedure minimizes exposure to the light source. When lightning or other unexpected conditions occur, crew members can preserve their dark adaptation by covering or closing one eye while using the other eye to observe. When the light source is no longer present, the eye that was covered provides the night-vision capability required for flight. The time spent expending ordnance should be limited. Minimizing this time decreases the effect of flash from aerial weapon systems and keeps the light level low. When firing automatic weapons, crew members should use short bursts of fire. If a direct view of the light source cannot be avoided, cover or close one eye. Remember that dark adaptation occurs independently in each eye. Depth perception will be severely degraded or lost, however, because both eyes are no longer completely dark adapted.

## **NIGHT-VISION TECHNIQUES**

8-42. The human eye functions less efficiently at reduced ambient light levels. This reduction limits an aircrew member's visual acuity. Normal color vision decreases and finally disappears as the cones become inactive and the rods begin to function. Tower beacons, runway lights, or other colored lights can still be identified if the light is of sufficient intensity to activate the cones. Normal central daylight vision also decreases because of the night blind spot that develops in low illumination or dark viewing conditions. Therefore, the proper techniques for night-vision viewing must be used to overcome the reduced visual acuity at lower light levels.

### **OFF-CENTER VISION**

8-43. Viewing an object with central vision during daylight poses no limitation. If this same technique is used at night, however, the object may not be seen. This is due to the night blind spot that exists under low light

illumination. To compensate for this limitation, off-center vision must be used. Figure 8-12 illustrates the off-center vision technique. With this technique, crew members view an object by looking 10 degrees above, below, or to either side rather than directly at the object. Thus, the eyes can maintain visual contact with an object via peripheral vision. Aircrew members should avoid viewing objects for either too short or too long a time.

8-44. Rapid head or eye movements and fixations decrease the integrating capability of the dark-adapted eye. A steady fixation lasting one-half to one second achieves the maximum sensitivity.

8-45. An object viewed longer than two to three seconds tends to bleach out and become one solid tone. Therefore, the object can no longer be seen. This creates a potentially unsafe operating condition. The aircrew member must be aware of the phenomenon and avoid viewing an object longer than two to three seconds. By shifting the eyes from one off-center point to another, the aircrew member can see the object in the peripheral field of vision.

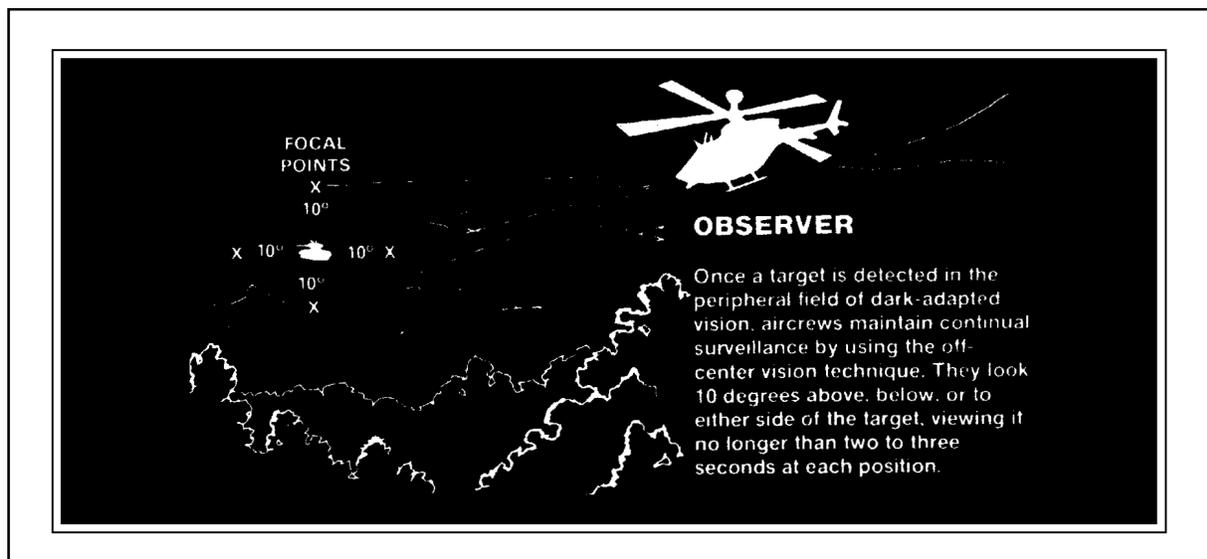

Figure 8-12. Off-Center Vision Technique

## SCANNING

8-46. During daylight, objects can be perceived at a great distance with good detail. At night, the range is limited and detail is poor. Objects along the flight path can be more readily identified at night when aircrew members use the proper techniques to scan the terrain. To scan effectively, aircrew members look from right to left or left to right. They should begin scanning at the greatest distance at which an object can be perceived (top) and move inward toward the position of the aircraft (bottom). Figure 8-13 shows this scanning pattern. Because the light-sensitive elements of the retina are unable to perceive images that are in motion, a stop-turn-stop-turn motion should be used. For each stop, an area about 30 degrees wide should be scanned. This viewing angle will include an area about 250 meters wide at a

distance of 500 meters. The duration of each stop is based on the degree of detail that is required, but no stop should last more than two or three seconds. When moving from one viewing point to the next, aircrew members should overlap the previous field of view by 10 degrees. This scanning technique allows greater clarity in observing the periphery. Other scanning techniques, as illustrated in Figure 8-14, may be developed to fit the situation.

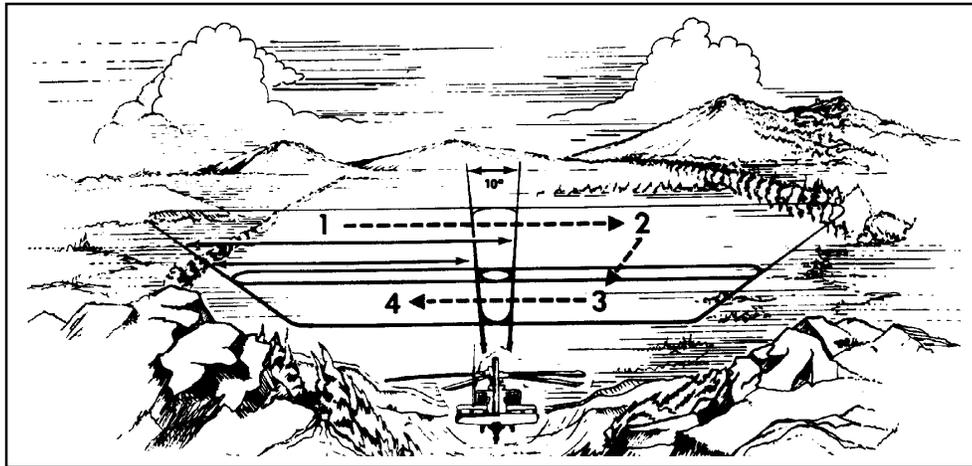

Figure 8-13. Scanning Pattern

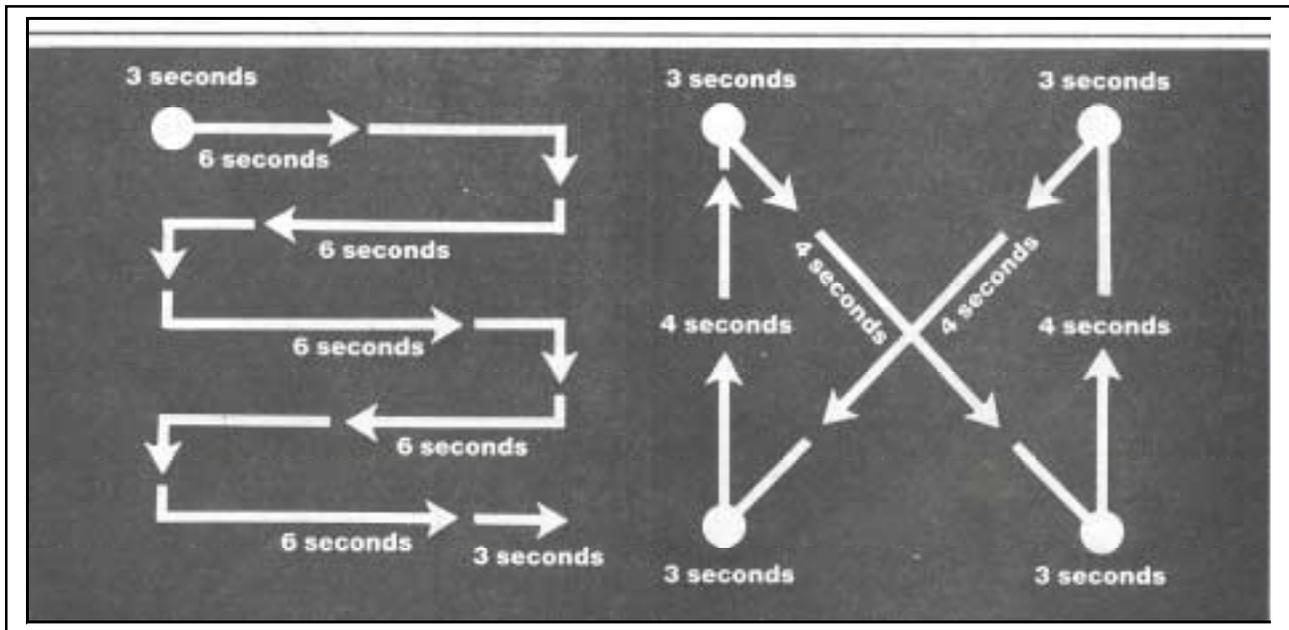

Figure 8-14. Typical Scanning Techniques

### SHAPES OR SILHOUETTES

8-47. Because visual acuity is reduced at night, objects must be identified by their shapes or silhouettes. To use this technique, the aircrew member must

be familiar with the architectural design of structures in the area covered by the mission. A silhouette of a building with a high roof and steeple can easily be recognized as a church in the United States. However, religious buildings in other parts of the world may have low-pitched roofs with no distinguishing features, to include cylinder-shaped structures. For example, the cylinder-shaped structures attached to Muslim mosques (religious temples), called minarets, are similar in shape to the silos attached to barns in the United States. Features depicted on the map will also aid in recognizing silhouettes.

## **DISTANCE ESTIMATION AND DEPTH PERCEPTION**

8-48. The cues to distance estimation and depth perception are easy to recognize when aircrew members use central vision under good illumination. As light levels decrease, their ability to judge distance accurately degrades and their eyes are vulnerable to illusions. Aircrew members can better judge distance at night if they understand the mechanisms of visual cues related to distance estimation and depth perception. Distance can be estimated by using individual cues or by using a variety of cues. Aircrew members normally use subconscious factors to determine distance. They can more accurately estimate distance if they understand those factors and then learn to look for or be aware of other distance cues. These cues to distance or depth perception may be monocular or binocular.

### **BINOCULAR CUES**

8-49. Binocular cues depend on the slightly different view each eye has of an object. Thus, binocular perception is of value only when the object is close enough to make a perceptible difference in the viewing angle of both eyes. In the flight environment, most distances outside the cockpit are so great that the binocular cues are of little, if any, value. In addition, binocular cues operate on a more subconscious level than do monocular cues. Study and training will not greatly improve them; therefore, they are not covered in this publication.

### **MONOCULAR CUES**

8-50. Several monocular cues aid in distance estimation and depth perception. These cues are geometric perspective, motion parallax, retinal image size, and aerial perspective. They can be remembered by the acronym GRAM.

#### **Geometric Perspective**

8-51. An object appears to have a different shape when crew members view it at varying distances and from different angles. The types of geometric perspective include linear perspective, apparent foreshortening, and vertical position in the field. Figure 8-15 illustrates these. They can be remembered by the acronym LAV.

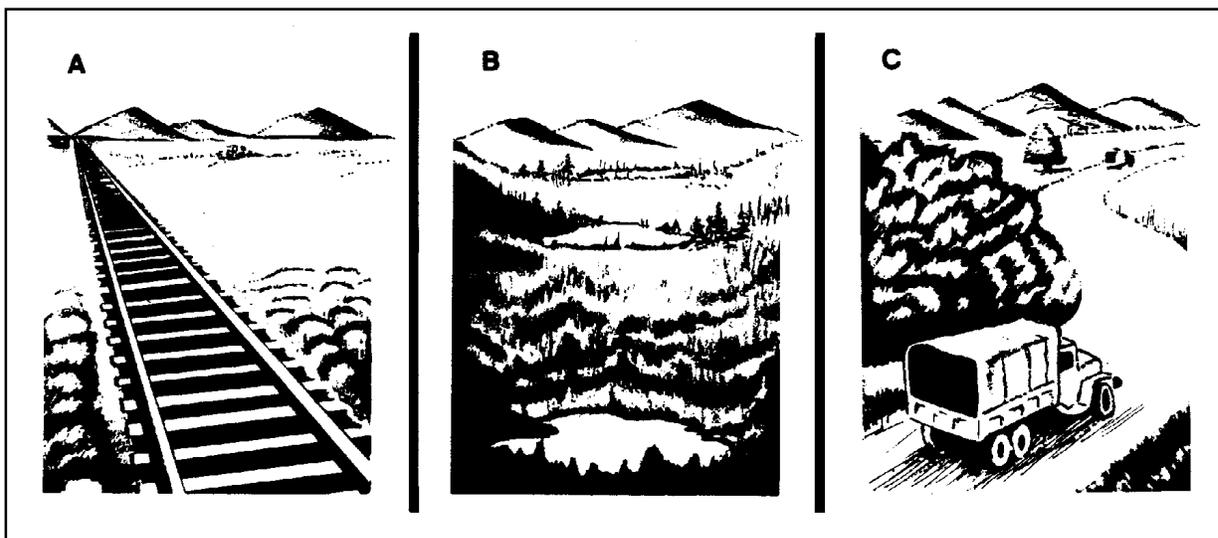

Figure 8-15. Geometric Perspective

8-52. **Linear Perspective.** Parallel lines, such as railroad tracks, tend to converge as distance from the observer increases. This is illustrated in part A of Figure 8-15.

8-53. **Apparent Foreshortening.** The true shape of an object or terrain feature appears elliptical (oval and narrowed appearance) when viewed from a distance when aircrew members are flying at both higher and lower altitudes. As the distance to the object or terrain feature decreases, the apparent perspective changes to its true shape or form. When flying at lower altitudes and viewing at greater distances, aircrew members may not view objects clearly. If the mission permits, pilots should gain altitude and decrease distance from the viewing area to compensate for this perspective. That is, once the aircraft increases in altitude and distance between the aircraft and the viewing area decreases, the viewing field widens and enlarges so that objects within that field of view become apparent. Part B of Figure 8-15 illustrates how the shape of a body of water changes when viewed at different distances while the aircraft maintains the same altitude.

8-54. **Vertical Position in the Field.** Objects or terrain features that are at greater distances from the observer appear higher on the horizon than do those that are closer to the observer. In part C of Figure 8-15, the higher vehicle appears to be closer to the top and is judged as being at a greater distance from the observer. Before flight, aircrew members should already be familiar with the actual sizes, heights, or altitudes of known objects or terrain features within and around the planned flight route. If the situation and time permit, aircrew members can reference published information to verify actual sizes, heights of objects, and terrain features within their flight path. In addition, the aircrew members should cross-reference their aircraft's altitude indicator to confirm that actual aircraft altitude is adequate to safely negotiate the object or terrain feature without prematurely changing the aircraft's heading, altitude, or attitude or a combination of these.

## Motion Parallax

8-55. This is often considered the most important cue to depth perception. Motion parallax refers to the apparent, relative motion of stationary objects as viewed by an observer who is moving across the landscape. Near objects appear to move past or opposite the path of motion; far objects seem to move in the direction of motion or remain fixed. The rate of apparent movement depends on the distance that the observer is from the objects. Objects near the aircraft appear to move rapidly, while distant objects appear to be almost stationary. Thus, objects that appear to be moving rapidly are judged to be near while those moving slowly are judged to be at a greater distance. Motion parallax can be apparent during flight. One example is an aircraft flying at 5,000 feet AGL. At that altitude, the terrain off in the distance appears to be stationary. The terrain immediately below and to either side of the aircraft may appear to be moving slowly, depending on the forward airspeed of the aircraft. The opposite is true when an aircraft descends to 80 feet AHO with a forward airspeed of 120 knots. The terrain and objects in the horizon appear to move at a faster rate, while the terrain and objects underneath and to either side of the aircraft appear to pass by at a high rate of speed.

## Retinal Image Size

8-56. **Distance Estimation.** An image focused on the retina is perceived by the brain to be of a given size. The factors that aid in determining distance using the retinal image are known size of objects, increasing and decreasing size of objects, terrestrial association, and overlapping contours or interposition of objects. These factors can be remembered by the acronym KITO.

8-57. **Known Size of Objects.** The nearer an object is to the observer, the larger its retinal image. By experience, the brain learns to estimate the distance of familiar objects by the size of their retinal image. Figure 8-16 shows how this method is used. A structure projects a specific angle on the retina, based on its distance from the observer. If the angle is small, the observer judges the structure to be at a great distance. A larger angle indicates to the observer that the structure is close. To use this cue, the observer must know the actual size of the object and have prior visual experience with it. If no experience exists, aircrew members determine the distance to an object primarily by motion parallax.

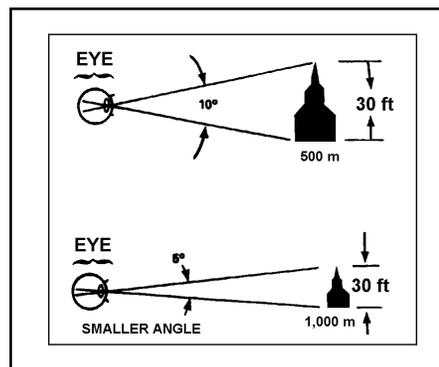
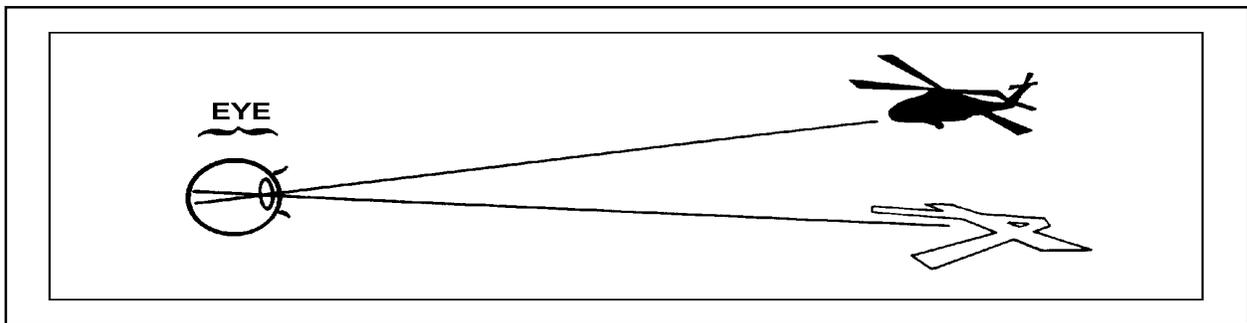

Figure 8-16. Known Size of Object Used to Determine Distance

**8-58. Increasing or Decreasing Size of Objects.** If the retinal image of an object increases in size, the object is moving closer to the observer. If the retinal image decreases, the object is moving farther away. If the retinal image is constant, the object is at a fixed distance.

**8-59. Terrestrial Association.** Comparison of one object, such as an airfield, with another object of known size, such as a helicopter, will help to determine the relative size and apparent distance of the object from the observer. Figure 8-17 shows that that objects ordinarily associated together are judged to be at about the same distance. For example, a helicopter that is observed near an airport is judged to be in the traffic pattern and, therefore, at about the same distance as the airfield.



**Figure 8-17. Terrestrial Association of Objects Used to Determine Distance**

**8-60. Overlapping Contours or Interposition of Objects.** When objects overlap, the overlapped object is farther away. For example, an object partly concealed by another object is behind the object that is concealing it. Aircrew members must be especially conscious of this cue when making an approach for landing at night. Lights disappearing or flickering in the landing area should be treated as barriers, and the flight path should be adjusted accordingly. Figure 8-18 illustrates overlapping contour.

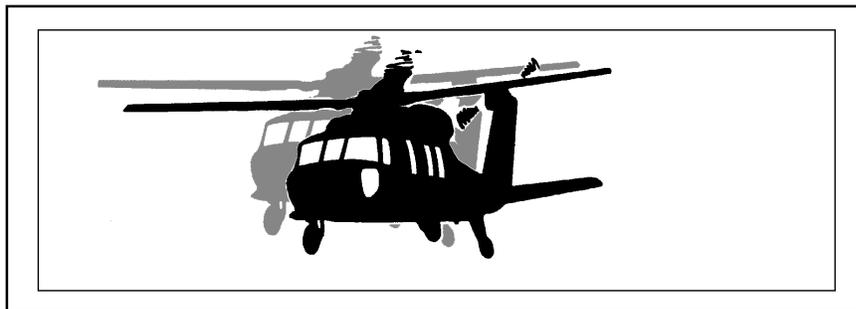
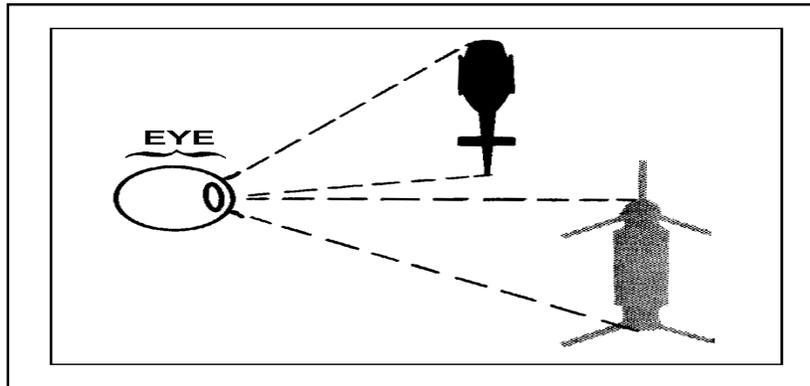

**Figure 8-18. Overlapping Contour Used to Determine Distance**

### Aerial Perspective

**8-61.** The clarity of an object and the shadow cast by it are perceived by the brain and are cues for estimating distance. To determine distance with these aerial perspectives, aircrew members use the factors discussed below.

**8-62. Fading of Colors or Shades.** Objects viewed through haze, fog, or smoke are seen less distinctly and appear to be at a greater distance than they actually are. If atmospheric transmission of light is unrestricted, an object is seen more distinctly and appears to be closer than it actually is. For example, the cargo helicopter in Figure 8-19 is larger than the observation helicopter, but because of the difference in viewing distance and size, they both project the same angle on the observer's retina. From this cue alone, assuming the observer has no previous experience with their appearance, both helicopters appear to be the same size. However, if the cargo helicopter is known to be a larger aircraft but is seen less distinctly because of visibility restrictions, it would be judged to be farther away and larger than the observation helicopter. Another example is that aircrew members may not be able to distinguish green from red anticollision lights and the actual interval between aircraft when an additional aircraft is operating at a distance. Both lights may appear to be white, and in addition, they may even blend in with the surrounding foreground.



**Figure 8-19. Fading Color or Shade Used to Determine Distance**

**8-63. Loss of Detail or Texture.** The farther from an object that an observer is, the less apparent discrete details become. For example, a cornfield at a distance becomes a solid color, leaves and branches of a tree become a solid mass, and objects are judged to be at a great distance. With the aircraft operating on the ground, crew members view the grass or gravel immediately below, in front of, or alongside the aircraft. As the aircraft slowly ascends, they maintain a view of that grass or gravel. Aircrew members will notice that, as the aircraft ascends, the clarity and detail of the grass is fading and eventually blends in with the terrain as a whole, causing the viewer not to be able to identify blades of grass or gravel. Environmental factors increase the effects of degraded texture and detail of objects throughout the visual field. This loss of detail, in turn, severely decreases depth perception and is a contributing factor in relation to aircrew members' misjudgments of what is seen or not seen and the occurrence of incidents related to those misjudgments.

**8-64. Position of Light Source and Direction of Shadow.** Every object will cast a shadow if there is a source of light. The direction in which the

shadow is cast depends on the position of the light source. If the shadow is cast toward the observer, the object is closer than the light source to the observer. Figure 8-20 shows how light and shadow help determine distance.



Figure 8-20. Position of Light Source and Direction of Shadow Used to Determine Distance

## VISUAL ILLUSIONS

8-65. As visual information decreases, the probability of spatial disorientation increases. Reduced visual references also create several illusions that can cause spatial disorientation. Chapter 9 covers these illusions in more detail.

## METEOROLOGICAL CONDITIONS AND NIGHT VISION

8-66. Although a flight may begin with clear skies and unrestricted visibility, meteorological conditions may deteriorate during flight. Because of reduced vision at night, clouds can appear gradually and easily go undetected by aircrew members. The aircraft may even enter the clouds inadvertently and without warning. At low altitudes, fog and haze can be encountered. Visibility can deteriorate gradually or suddenly. Because it is difficult to detect adverse weather at night, crew members should be constantly aware of changing weather conditions. The following conditions are indicators of adverse weather at night.

8-67. The ambient light level is gradually reduced as cloud coverage increases. Visual acuity and contrast of terrain features are lost, possibly to complete obscurity. If this condition should occur, pilots should initiate inadvertent IMC procedures. Aircrew members must follow their local SOPs and command directives and realize that inadvertent IMC at night is one of the leading causes of Class A mishaps.

8-68. If the moon and stars cannot be seen, clouds are present. The less visible the stars and moon, the heavier the cloud coverage.

8-69. Clouds obscuring the illumination of the moon create shadows. These shadows can be detected by observing the varying levels of ambient light along the flight route.

8-70. The halo effect, which is observed around ground lights, indicates the presence of moisture and possible ground fog. As the fog and moisture increase, the intensity of the lights will decrease. This same effect is apparent during flight. As moisture increases, the light that is emitted from the aircraft is reflected back upon the aircraft. When this reflection occurs, it is possible to misjudge terrain features, man-made structures, and the actual position, heading, and altitude of other aircraft including the layout and height of the terrain below.

8-71. The presence of fog over water surfaces indicates that the temperature and dew point are equal. It also indicates that fog may soon form over ground areas.

## SELF-IMPOSED STRESS AND VISION

8-72. The normal aviation stress that aircrew members experience in flight, such as altitude, may not be controllable and may affect mission performance somewhat. In addition, those involved in aviation must cope with self-imposed stress. Unlike aviation stress, aircrew members themselves can control self-imposed stress. The factors that cause this stress are drugs, exhaustion, alcohol, tobacco, and hypoglycemia and nutrition. These factors, shown in Figure 8-21, can be remembered by the acronym DEATH (refer to AR 40-8).

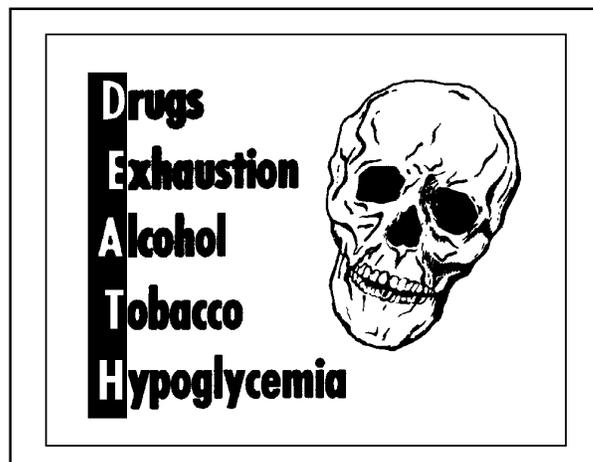

Figure 8-21. Self-Imposed Stress Factors

## DRUGS

8-73. Adverse side effects associated with drug use are illness and degradation in motor skills, awareness level, and reaction time. Aircrew

members who become ill should consult the flight surgeon. Crew members should avoid self-medicating; it is unauthorized for flight personnel. AR 40-8 contains restrictions on drug use while on flight status.

## **EXHAUSTION**

8-74. Tiredness reduces mental alertness. In situations that require immediate reaction, exhaustion causes aircrew members to respond more slowly. They tend to concentrate on one aspect of a situation without considering the total environment. Rather than use proper scanning techniques, they are prone to stare, which may cause incidents. Good physical conditioning should decrease fatigue and improve night-scanning efficiency. However, excessive exercise in a given day can lead to increased fatigue. Night flying is more stressful than day flying. Aircrew members should follow prescribed crew-rest policies. Multiple factors cause exhaustion; normally, exhaustion does not set in from one factor alone. Contributing factors associated with exhaustion include poor diet habits, lack of rest, poor sleeping patterns, poor physical condition, an inadequate exercise routine, environmental factors, dehydration, and combat stress. In combination, these can create exhaustion. Common side effects associated with exhaustion include altered levels of concentration, awareness, and attentiveness; increased drowsiness (nodding off or falling asleep); and ineffective night-vision viewing techniques (staring, rather than scanning).

## **ALCOHOL**

8-75. Alcohol causes a person to become uncoordinated and impairs judgment. It hinders the aircrew member's ability to view properly. The aircrew member is likely to stare at objects and neglect proper scanning techniques, particularly at night. In addition, as is indicated by the physiological response of the body to a hangover, the effects of alcohol are long lasting. Alcohol induces histotoxic hypoxia, which is the poisoning of the bloodstream, interfering with the use of oxygen by body tissues. One ounce of alcohol in the bloodstream at sea level places an individual at 2,000 feet physiologically. Every ounce of alcohol in the bloodstream at sea level increases the body's physiological altitude. For example, an individual who consumes three ounces of alcohol at sea level and is then placed at 4,000 feet actual pressure altitude has a physiological altitude of 10,000 feet. Now, combined with the histotoxic hypoxia effects is hypoxic hypoxia. This individual's time of useful consciousness is severely impaired. If the flight is longer than 60 minutes, the individual may become unconscious and may even die from lack of oxygen, by textbook definition (AR 95-1, altitude restrictions without the use of supplemental oxygen). The guidance for performing or resuming aircrew member duties when alcohol is involved is 12 hours after the last consumed alcohol with no residual physiological effects present. Aircrew member duties include preflight and postflight actions, to include maintenance; they are not limited to actual operation of the aircraft or flight. Detrimental effects associated with the consumption of alcohol include poor judgment, decision making, perception, reaction time, coordination, and scanning techniques (tendency to stare at objects).

**TOBACCO**

8-76. Of all self-imposed stresses, cigarette smoking decreases visual sensitivity at night the most. The hemoglobin of the red blood cells has a 200 to 300 times greater affinity for carbon monoxide than for oxygen. That is, the hemoglobin accepts the carbon monoxide far more rapidly than it will accept oxygen. During normal pulmonary perfusion (gas exchange within the lungs), carbon dioxide is released from the bloodstream when an individual exhales. When an individual inhales, the normal action is that oxygen is absorbed into the blood (hemoglobin of the red blood cell); thus, normal levels of oxygen and other gas levels are being maintained within the bloodstream. Smoking increases CO, which in turn, reduces the capacity of the blood to carry oxygen. The hypoxia that results from this increase in carbon monoxide is hypemic hypoxia, which negatively affects the aircrew member's peripheral vision and dark adaptation. If, for example, an individual smokes 3 cigarettes in rapid succession or 20 to 40 cigarettes within a 24-hour period, the carbon monoxide content of the blood is raised 8 to 10 percent. The physiological effect at ground level is the same as flying at 5,000 feet. More importantly, the smoker has lost about 20 percent of night-vision capability at sea level. Table 8-1 compares reduced night vision at varying altitudes for smokers and nonsmokers.

**Table 8-1. Percentage Reduction of Night Vision at Varying Altitudes for Smokers and Nonsmokers**

<b>Altitude (feet)</b>	<b>Nonsmoker (%)</b>	<b>Smoker (%)</b>
4,000	Sea Level	20
6,000	5	25
10,000	20	40
14,000	35	55
16,000	40	50

**HYPOGLYCEMIA AND NUTRITIONAL DEFICIENCY**

8-77. Aviation personnel should avoid missing or postponing meals. They should also avoid supplementing primary meals with fast sugars (for example, sodas and candy bars). These foods and beverages can cause low blood-sugar levels. Low blood-sugar levels may result in hunger pangs, distraction, a breakdown in habit patterns, a shortened attention span, and other physiological changes. Supplementing with fast sugars as the primary diet will, on average, sustain the individual for up to 30 to 45 minutes. The negative effects will then increase in intensity. Not only can an improper diet cause hypoglycemia, but a diet that is deficient in Vitamin A can also impair night vision. Vitamin A is an essential element in the buildup of rhodopsin (visual purple) for stimulation of the rod cells. Without this buildup of rhodopsin, night vision is severely degraded. An adequate intake of Vitamin A—through a balanced diet that includes such foods as eggs, butter, cheese, liver, carrots, and most green vegetables—will help maintain visual acuity. Aircrew members must consult a flight surgeon before consuming Vitamin A supplements that are not organic to the foods noted above.

## **NERVE AGENTS AND NIGHT VISION**

8-78. Night vision is adversely affected when the eyes are exposed to minute amounts of nerve agents. When direct contact occurs, the pupils constrict (miosis) and do not dilate in low ambient light. The available automatic chemical alarms are not sensitive enough to detect the low concentrations of nerve-agent vapor that can cause miosis.

8-79. The exposure time required to cause miosis depends on agent concentration. Miosis may occur gradually as eyes are exposed to low concentrations over a long period. On the other hand, exposure to a high concentration can cause miosis during the few seconds it takes to put on a protective mask. Repeated exposure over a period of days is cumulative.

8-80. The symptoms of miosis range from minimal to severe, depending on the dosage to the eye. Severe miosis, with the resulting reduced ability to see in low ambient light, persists for about 48 hours after onset. The pupil gradually returns to normal over several days. Full recovery may take up to 20 days. Repeated exposure within the affected time will be cumulative.

8-81. The onset of miosis is insidious because it is not always immediately painful. Miotic subjects may not recognize their condition, even when they carry out tasks requiring vision in low ambient light. After an attack by nerve agents, especially the more persistent types, commanders should assume that some loss of night vision has occurred among personnel otherwise fit for duty and consider grounding the aircrew members until they fully recover. All exposed aircrew members and aircraft-related maintenance personnel must consult medical personnel and the flight surgeon immediately after exposure.

## **FLIGHT HAZARDS**

8-82. Solar glare, bird strikes, nuclear flash, and lasers are possible hazards that an aircrew member may encounter during low-level flight.

### **SOLAR GLARE**

8-83. Glare from direct, reflected, or scattered sunlight causes discomfort and reduces visual acuity. To reduce or eliminate discomfort, every aircrew member should wear, lowered, the tinted visor or wear issued ND-15 sunglasses with the clear visor. Day blindness can occur in areas of extreme solar glare (in snow, over water, or in desert environments).

### **BIRD STRIKES**

8-84. This hazard can occur during the day or at night during low-level flight. Cockpit windshields are designed to withstand impacts, but the potential exists for shattering. According to the FAA, if an aircraft traveling at an airspeed equivalent to a 120-mile-per-hour ground speed strikes a two-pound seagull, the force exerted would be equal to 4,800 pounds. Some anti-aircraft rounds exert less force than that. Therefore, the clear visor for night flights and the tinted visor for day flights (if the viewing environment warrants) should be worn (lowered) by aircrew members. These visors would not only protect their eyes from the remains of the bird but also, more importantly, from the glass fragments of the windshield.

## NUCLEAR FLASH

8-85. A fireball from a nuclear explosion can produce flash blindness and cause retinal burns. By day, the optical blink reflex should prevent retinal burns from distances where survival is possible. At night, when the pupil is dilated, retinal burns are possible and indirect flash blindness can deprive aircrew members of all useful vision for periods exceeding one minute. No practical protection against nuclear flash has been developed.

## LASERS

8-86. Mobile military lasers currently work by converting electrical and chemical energy into light. This light can be either continuously emitted or collected over time and suddenly released. A laser is light amplified by a stimulated emission of radiation through one prism or a series of multiple prisms, which increases the laser-light frequency and intensity. The beam of light produced is usually less than one inch in diameter; the beam may or may not be visible to the naked eye (ultraviolet, infrared, and thermal lasers). Laser range finders and target designators, except for thermal infrared lasers, operate by accumulating and suddenly releasing light energy in the form of a crystal rod. This rod is about the size of a cigarette. The laser pulse is controlled by an electrical signal that turns the laser on and off. Laser pulses travel at the speed of light—300,000 kilometers per second. During a laser pulse, when the laser is actually emitting light, the power output is an average of about 3 megawatts (3 million watts) along a narrow beam. About 90 percent of the energy emitted is contained in this narrow beam. This characteristic of lasers makes them useful as range finders and target designators but also makes them dangerous to human eyes. Lasers can damage eyes from a considerable distance although the diameter of the laser beam widens as distance increases, thus reducing its energy level. Distance is the best protection, but if that is not possible, then protective ballistic and laser protective eyewear goggles or visors may offer limited protection. These BLPs are laser-frequency specific. Aircrew members need to identify what type of laser-frequency threat that they may encounter to receive the correct type of BLP eyewear from their unit ALSE technician. Smoke, fog, and dust weaken laser light. A useful rule is that “if you see the target through smoke, laser energy can hit the target and the laser energy can also strike your eyes.” In daylight, even visual-light lasers are “invisible” unless there is smoke, mist, or fog in the air. The four major classes of directed-energy systems are high-energy lasers, low-energy lasers, radio-frequency lasers, and particle-beam lasers. The following is a breakdown of all four classifications.

### Class 1

8-87. Class 1 laser devices do not emit hazardous laser radiation under any operating or viewing condition. These lasers include those that are fully enclosed; for example, PAQ-4A/B/C infrared aiming lights and many of the laser marksmanship trainers.

**Class 2**

8-88. Class 2 laser devices are usually continuous-wave visible laser devices. Precautions are required to prevent staring into the direct beam. Momentary exposure (greater than 0.25 second) is not considered hazardous; for example, current (updated) laser pointers, construction lasers, and alignment lasers.

**Class 3a**

8-89. Class 3a lasers normally are not hazardous unless crew members view them with magnifying optics from within the beam. These type of lasers include visible and invisible frequency lasers; for example, a miniature eye-safe laser infrared observation set, commonly known as melios.

**Class 3b**

8-90. Class 3b lasers are potentially hazardous if the direct or specularly reflected beam is viewed by unprotected eyes. Care is required to prevent intrabeam (within the beam) viewing and to control specular (such as from mirrors or still water) reflections. This type of laser includes many range finders and the AIM-1, GCP-1, and AN/PEQ-2A laser pointers.

**Class 4**

8-91. Class 4 lasers are pulsed, visible, and near-infrared lasers that can produce diffuse reflections, fire, and skin hazards (especially to the eyes). These lasers have an average output of 500 milliwatts or more. Safety precautions generally consist of using door interlocks to protect personnel entering the laser facility from exposure, using baffles to terminate primary and secondary beams, and wearing protective eyewear and clothing. Aircrew members exposed to this type of laser inadvertently or without prior warning would receive serious retinal burns within tenths of a second exposure time if their eyes were unprotected. For military operations during peacetime, these lasers are normally operated only on cleared, approved laser ranges or while personnel are using appropriate eye/skin protection. However, actual opposing forces may intentionally expose crew members to deplete the aircrew's fighting capability. This class of laser includes industrial welders and target-designator lasers.

**PROTECTIVE MEASURES****BUILT-IN PROTECTIVE MEASURES**

8-92. Filters can stop laser light. These filters are pieces of glass or plastic that absorb or reflect light of a given color (wavelength). Sunglasses are especially created to filter visual light. An infrared or ultraviolet laser will pass through these types of glass and still damage the eyes. Presently, the Army has protective eyewear that will assist in preventing ocular injuries from certain types of lasers; for example, B-LPs.

## **PASSIVE PROTECTIVE MEASURES**

8-93. Passive protective measures also help protect from laser injury. Passive protective measures consist of—

- Taking cover.
- Getting out of the path of the laser beam.
- Using available protective gear.
- Keeping all exposed skin areas covered to prevent skin burns.

## **ACTIVE PROTECTIVE MEASURES**

8-94. Active protective measures consist of—

- Using countermeasures, as taught or directed by the unit commander.
- Applying evasive action.
- Scanning the battlefield with one eye or monocular optics.
- Minimizing the use of binoculars in areas where lasers may be in use.

Crew members should use hardened optical systems and built-in or clip-on filters (BLPs) and deploy smoke, if capable. FM 4-02.50(8-50) contains information regarding prevention and medical management of laser injuries.

## **PRINCIPLES OF PROPER VISION**

8-95. Aircrew members must completely understand the function of the eye and the techniques that they can employ to overcome visual limitations. It is usually not the lack of visual acuity that causes problems for aircrew members but rather a lack of understanding of “how to see” properly. In summary, the principles of proper vision require that aircrew members—

- Understand the types of vision and the limitations of each and that visual acuity will normally be lost under low levels of illumination.
- If corrective lens are prescribed to aircrew members, they must use corrective lens (glasses) in all modes of flight to include night-aided (ANVIS, night-vision devices/goggle systems) flight.
- Be aware that it will take 30 to 45 minutes for the average individual's eyes to reach maximum dark adaptation.
- Remember to use off-center vision when viewing objects under reduced lighting conditions.
- Use supplemental oxygen, if available, on flights (especially night flights) at or above 4,000 feet pressure altitude.
- Avoid self-imposed stress.
- Protect night vision by avoiding bright lights once dark adaptation has been achieved.
- Scan constantly when viewing objects outside the cockpit, day or night.
- Know and understand the effects of nerve agents and take protective measures against laser injury.

## Chapter 9

# Spatial Disorientation

Spatial disorientation contributes more to causing aircraft accidents than any other physiological problem in flight. Regardless of their flight-time experience, all aircrew members are subject to disorientation. The human body is structured to perceive changes in movement on land in relation to the surface of the earth. In an aircraft, the human sensory systems—the visual, vestibular, and proprioceptive systems—may give the brain erroneous orientation information. This information can cause sensory illusions, which may lead to spatial disorientation.

## COMMON TERMS OF SPATIAL DISORIENTATION

### SPATIAL DISORIENTATION

9-1. Spatial disorientation is an individual's inability to determine his or her position, attitude, and motion relative to the surface of the earth or significant objects; for example, trees, poles, or buildings during hover. When it occurs, pilots are unable to see, believe, interpret, or prove the information derived from their flight instruments. Instead, they rely on the false information that their senses provide.

### SENSORY ILLUSION

9-2. A sensory illusion is a false perception of reality caused by the conflict of orientation information from one or more mechanisms of equilibrium. Sensory illusions are a major cause of spatial disorientation.

### VERTIGO

9-3. Vertigo is a spinning sensation usually caused by a peripheral vestibular abnormality in the middle ear. Aircrew members often misuse the term vertigo, applying it generically to all forms of spatial disorientation or dizziness.

## TYPES OF SPATIAL DISORIENTATION

### TYPE I (UNRECOGNIZED)

9-4. A disoriented aviator does not perceive any indication of spatial disorientation. In other words, he does not think anything is wrong. What he sees—or thinks he sees—is corroborated by his other senses. Type I disorientation is the most dangerous type of disorientation. The pilot—unaware of a problem—fails to recognize or correct the disorientation, usually resulting in a fatal aircraft mishap:

- The pilot may see the instruments functioning properly. There is no suspicion of an instrument malfunction.
- There may be no indication of aircraft-control malfunction. The aircraft is performing normally.
- An example of this type of SD would be the height-/depth-perception illusion when the pilot descends into the ground or some obstacle above the ground because of a lack of situational awareness.

**TYPE II (RECOGNIZED)**

9-5. In Type II spatial disorientation, the pilot perceives a problem (resulting from spatial disorientation). The pilot, however, may fail to recognize it as spatial disorientation:

- The pilot may feel that a control is malfunctioning.
- The pilot may perceive an instrument failure as in the graveyard spiral, a classic example of Type II disorientation. The pilot does not correct the aircraft roll, as indicated by the attitude indicator, because his vestibular indications of straight-and-level flight are so strong.

**TYPE III (INCAPACITATING)**

9-6. In Type III spatial disorientation, the pilot experiences such an overwhelming sensation of movement that he or she cannot orient himself or herself by using visual cues or the aircraft instruments. Type III spatial disorientation is not fatal if the copilot can gain control of the aircraft.

**EQUILIBRIUM MAINTENANCE**

9-7. Three sensory systems—the visual, vestibular, and proprioceptive systems—are especially important in maintaining equilibrium and balance. Figure 9-1 shows these systems. Normally, the combined functioning of these senses maintains equilibrium and prevents spatial disorientation. During flight, the visual system is the most reliable. In the absence of the visual system, the vestibular and proprioceptive systems are unreliable in flight.

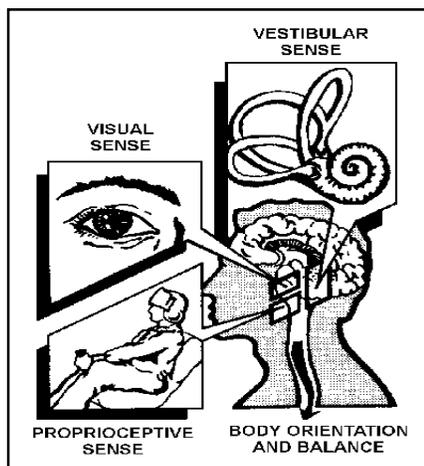

**Figure 9-1. The Three Equilibrium Systems**

## VISUAL SYSTEM

9-8. Of the three sensory systems, the visual system is the most important in maintaining equilibrium and orientation. To some extent, the eyes can help determine the speed and direction of flight by comparing the position of the aircraft relative to some fixed point of reference. Eighty percent of our orientation information comes from the visual system. (Chapter 8 contains information about the eye).

9-9. On flights under IMC, crew members lose fixed points of reference outside of the aircraft. Under IMC, the pilot must rely on visual sensory input from the instruments for spatial orientation. The decision to rely on the visual sense—and to believe the instruments rather than the input of the other senses—demands disciplined training.

9-10. The eyes allow the pilot to scan sensitive flight instruments that give accurate spatial-orientation information. These instruments indicate unusual aircraft attitudes resulting from turbulence, distraction, inattention, mechanical failure, or spatial disorientation.

## VESTIBULAR SYSTEM

9-11. The inner ear contains the vestibular system, which contains the motion- and gravity-detecting sense organs. This system is located in the temporal bone on each side of the head. Each vestibular apparatus consists of two distinct structures: the semicircular canals and the vestibule proper, which contain the otolith organs. Figure 9-2 depicts the vestibular system. Both the semicircular canals and the otolith organs sense changes in aircraft attitude. The semicircular canals of the inner ear sense changes in angular acceleration and deceleration.

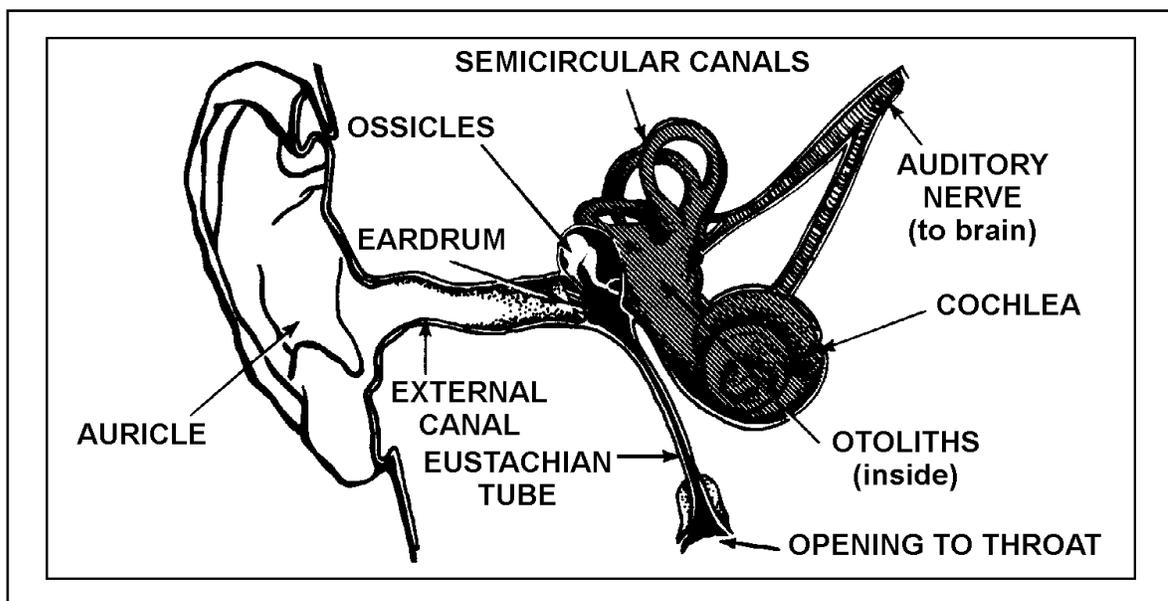
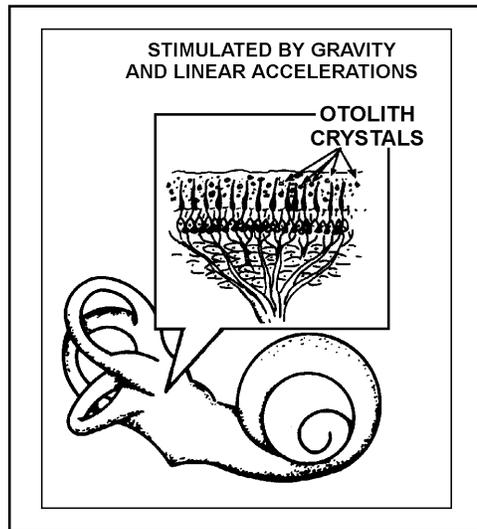

Figure 9-2. The Vestibular System

**Otolith Organs**

9-12. The otolith organs are small sacs located in the vestibule. Sensory hairs project from each macula into the otolithic membrane, an overlaying gelatinous membrane that contains chalklike crystals, called otoliths. The otolith organs, shown in Figure 9-3, respond to gravity and linear accelerations. Changes in the position of the head, relative to the gravitational force, cause the otolithic membrane to shift position on the macula. The sensory hairs bend, signaling a change in the head position.



**Figure 9-3. The Otolith Organs**

9-13. When the head is upright, a "resting" frequency of nerve impulses is generated by the hair cells. Figure 9-4 shows the position of the hair cells when the head is upright.

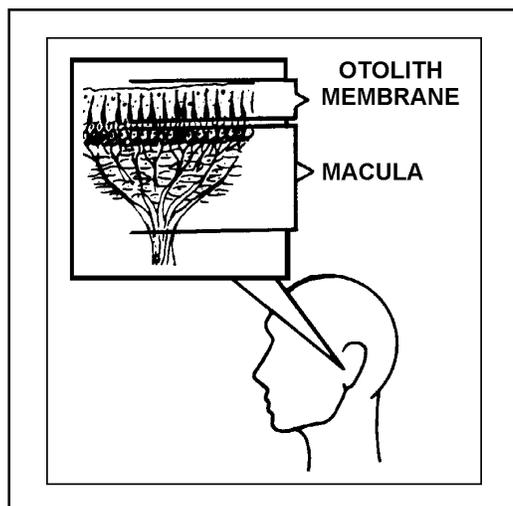

**Figure 9-4. Position of the Hair Cells When the Head Is Upright**

9-14. When the head is tilted, the “resting” frequency is altered. The brain is informed of the new position. The positions of the hair cells when the head is tilted forward and backward are shown in Figure 9-5.

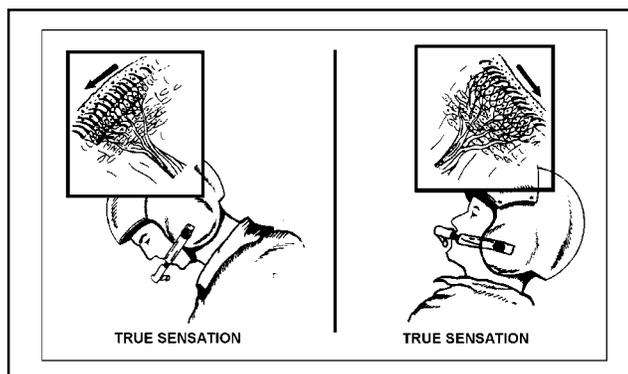

**Figure 9-5. Position of the Hair Cells When the Head Is Tilted Forward and Backward**

9-15. Linear accelerations/decelerations also stimulate the otolith organs. The body cannot physically distinguish between the inertial forces resulting from linear accelerations and the force of gravity. A forward acceleration results in backward displacement of the otolithic membranes. When an adequate visual reference is not available, aircrew members may experience an illusion of backward tilt. Figure 9-6 shows this false sensation of backward tilt.

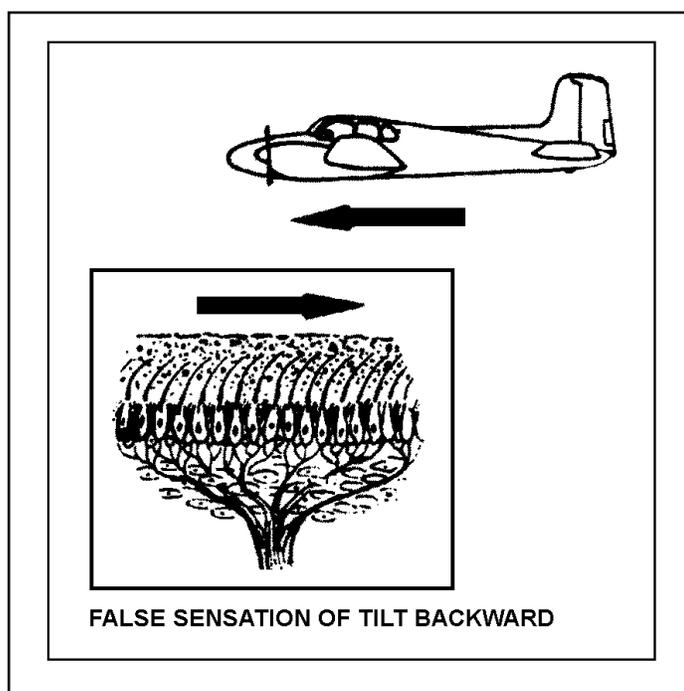

**Figure 9-6. False Sensation During Backward Tilt**

**SEMICIRCULAR CANALS**

9-16. The semicircular canals of the inner ear sense changes in angular acceleration. The canals will react to any changes in roll, pitch, or yaw attitude. Figure 9-7 shows where these changes are registered in the semicircular canals.

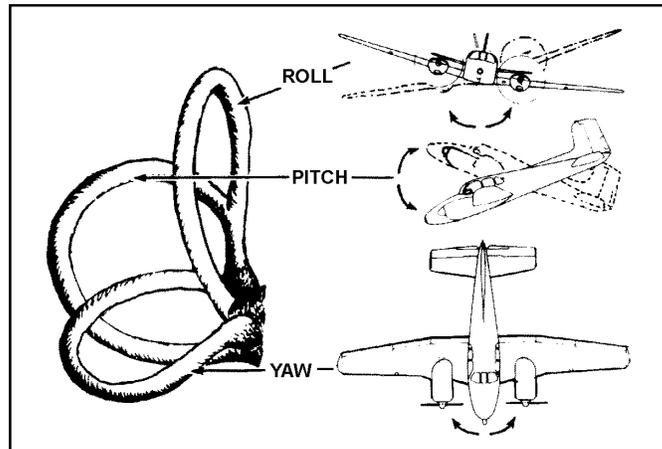

**Figure 9-7. Reaction of the Semicircular Canals to Changes in Angular Acceleration**

9-17. The semicircular canals are situated in three planes, perpendicular to each other. They are filled with a fluid called endolymph. The inertial torque resulting from angular acceleration in the plane of the canal puts this fluid into motion. The motion of the fluid bends the cupula, a gelatinous structure located in the ampulla of the canal. This, in turn, moves the hairs of the hair cells situated beneath the cupula. This movement stimulates the vestibular nerve. These nerve impulses are then transmitted to the brain, where they are interpreted as rotation of the head. Figure 9-8 shows a cutaway section of the semicircular canal.

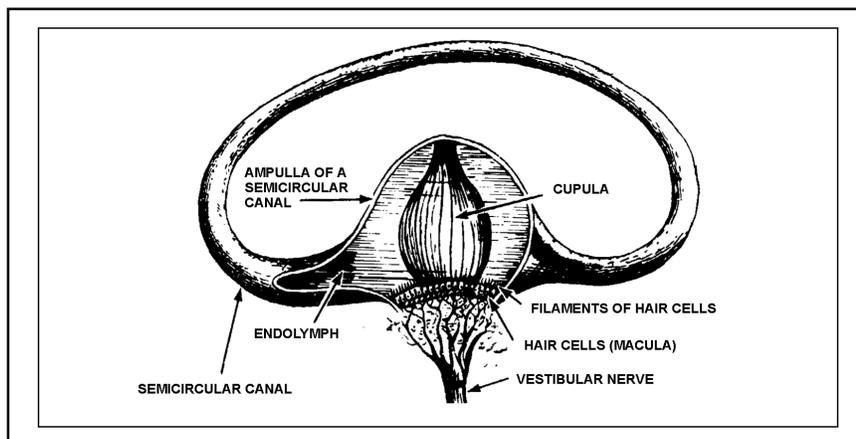

**Figure 9-8. Cutaway View of the Semicircular Canals**

9-18. When no acceleration takes place, the hair cells are upright. The body senses that no turn has occurred. The position of the hair cells and the actual sensation correspond, as shown in Figure 9-9.

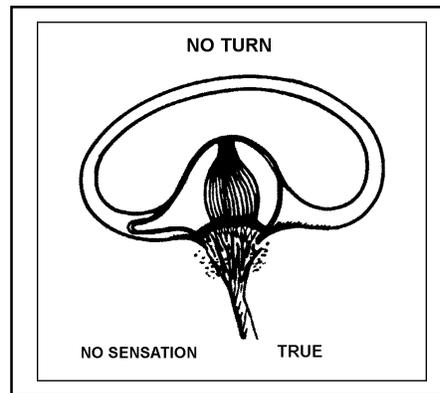

**Figure 9-9. Position of Hair Cells During No Acceleration**

9-19. When a semicircular canal is put into motion during clockwise acceleration, the fluid within the semicircular canal lags behind the accelerated canal walls. This lag creates a relative counterclockwise movement of the fluid within the canal. The canal wall and the cupula move in the opposite direction from the motion of the fluid. The brain interprets the movement of the hairs to be a turn in the same direction as the canal wall. The body correctly senses that a clockwise turn is being made. Figure 9-10 shows the position of the hair cells and the resulting true sensation during a clockwise turn.

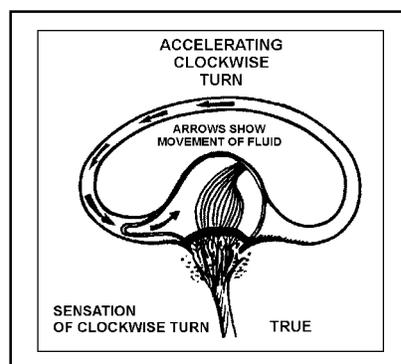

**Figure 9-10. Sensation During a Clockwise Turn**

9-20. If the clockwise turn then continues at a constant rate for several seconds or longer, the motion of the fluid in the canals catches up with the canal walls. The hairs are no longer bent, and the brain receives the false impression that turning has stopped. The position of the hair cells and the resulting false sensation during a prolonged, constant clockwise turn is shown in Figure 9-11. A prolonged constant turn in either direction will result in the false sensation of no turn.

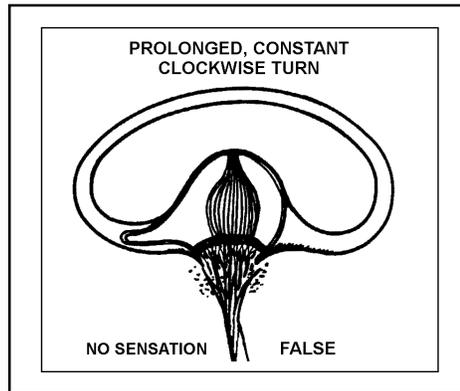

**Figure 9-11. Sensation During a Prolonged Clockwise Turn**

9-21. When the clockwise rotation of the aircraft slows or stops, the fluid in the canal moves briefly in a clockwise direction. This sends a signal to the brain that is falsely interpreted as body movement in the opposite direction. In an attempt to correct the falsely perceived counterclockwise turn, the pilot may turn the aircraft in the original clockwise direction. Figure 9-12 shows the position of the hair cells—and the resulting false sensation when a clockwise turn is suddenly slowed or stopped.

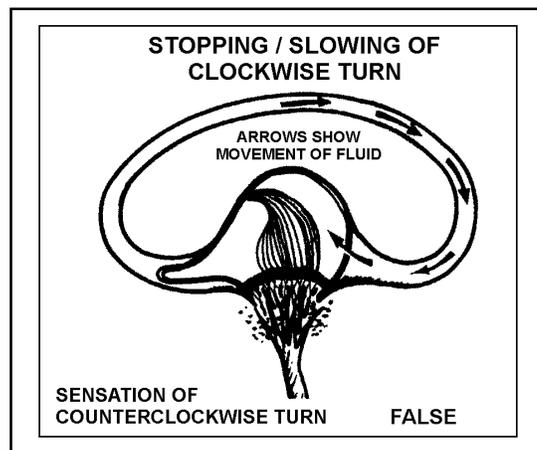

**Figure 9-12. Sensation During Slowing or Stopping of a Clockwise Turn**

### PROPRIOCEPTIVE SYSTEM

9-22. This system reacts to the sensation resulting from pressures on joints, muscles, and skin and from slight changes in the position of internal organs. It is closely associated with the vestibular system and, to a lesser degree, the visual system. Forces act upon the seated pilot in flight. With training and experience, the pilot can easily distinguish the most distinct movements of the aircraft by the pressures of the aircraft seat against the body. The recognition of these movements has led to the term “seat-of-the-pants” flying.

## VISUAL ILLUSIONS

9-23. Illusions give false impressions or misconceptions of actual conditions; therefore, aircrew members must understand the type of illusions that can occur and the resulting disorientation. Although the visual system is the most reliable of the senses, some illusions can result from misinterpreting what is seen; what is perceived is not always accurate. Even with the references outside the cockpit and the display of instruments inside, aircrew members must be on guard to interpret information correctly.

### RELATIVE-MOTION ILLUSION

9-24. Relative motion is the falsely perceived self-motion in relation to the motion of another object. The most common example is when an individual in a car is stopped at a traffic light and another car pulls alongside. The individual that was stopped at the light perceives the forward motion of the second car as his own motion rearward. This results in the individual applying more pressure to the brakes unnecessarily. This illusion can be encountered during flight in situations such as formation flight, hover taxi, or hovering over water or tall grass.

### CONFUSION WITH GROUND LIGHTS

9-25. Confusion with ground lights occurs when an aviator mistakes ground lights for stars. This illusion prompts the aviator to place the aircraft in an unusual attitude to keep the misperceived ground lights above them. Isolated ground lights can appear as stars and this could lead to the illusion that the aircraft is in a nose high or one wing low attitude (Part A of Figure 9-13). When no stars are visible because of overcast conditions, unlighted areas of terrain can blend with the dark overcast to create the illusion that the unlighted terrain is part of the sky (Part B of Figure 9-13). This illusion can be avoided by referencing the flight instruments and establishing a true horizon and attitude.

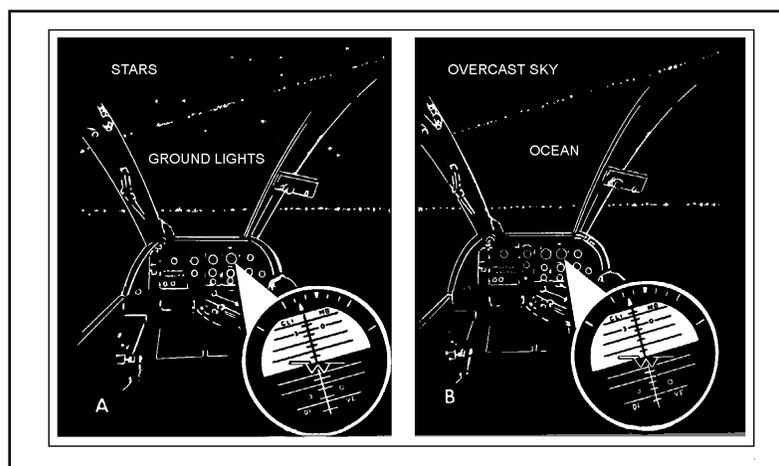

Figure 9-13. Confusion of Ground Lights and Stars at Night

## FALSE HORIZON ILLUSION

9-26. The false horizon illusion (Figure 9-14) occurs when the aviator confuses cloud formations with the horizon or the ground. This illusion occurs when an aviator subconsciously chooses the only reference point available for orientation. A sloping cloud deck may be difficult to perceive as anything but horizontal if it extends for any great distance in the pilot's peripheral vision. An aviator may perceive the cloudbank below to be horizontal although it may not be horizontal to the ground; thus, the pilot may fly the aircraft in a banked attitude. This condition is often insidious and goes undetected until the aviator recognizes it and makes the transition to the instruments and corrects it. This illusion can also occur if an aviator looks outside after having given prolonged attention to a task inside the cockpit. The confusion may result in the aviator placing the aircraft parallel to the cloudbank.

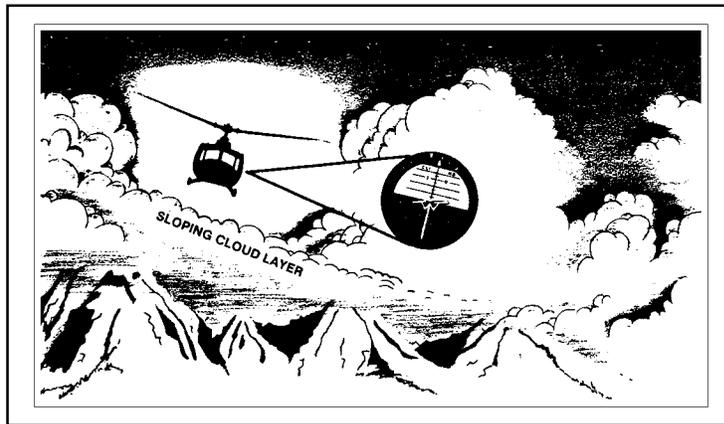

Figure 9-14. False Horizon Illusion

## HEIGHT-DEPTH PERCEPTION ILLUSION

9-27. The height-depth perception illusion is due to a lack of sufficient visual cues and causes an aircrew member to lose depth perception. Flying over an area devoid of visual references—such as desert, snow, or water—will deprive the aircrew member of his perception of height. The aviator, misjudging the aircraft's true altitude, may fly the aircraft dangerously low in reference to the ground or other obstacles above the ground. Flight in an area where visibility is restricted by fog, smoke, or haze can produce the same illusion.

## CRATER ILLUSION

9-28. The crater illusion occurs when aircrew members land at night, under NVG conditions, and the IR searchlight is directed too far under the nose of the aircraft. This will cause the illusion of landing with up-sloping terrain in all directions. This misperceived up-sloping terrain will give the aviator the perception of landing into a crater. This illusionary depression lulls the pilot into continuing to lower the collective. This can result in the aircraft prematurely impacting the ground, causing damage to both aircraft and crew. If observing another aircraft during hover taxi, the aviator may perceive that the crater actually appears to move with the aircraft being observed.

## STRUCTURAL ILLUSIONS

9-29. Structural illusions are caused by the effects of heat waves, rain, snow, sleet, or other visual obscurants. A straight line may appear curved when it is viewed through the heat waves of the desert. A single wing-tip light may appear as a double light or in a different location when it is viewed during a rain shower. The curvature of the aircraft windscreen can also cause structural illusions, as illustrated in Figure 9-15. This illusion is due to the refraction of light rays as they pass through the windscreen. When encountering environments that contain these visual obscurants, the aviator must remain aware that these obscurants may present a false perception.



Figure 9-15. Structural Illusion

## SIZE-DISTANCE ILLUSION

9-30. The size-distance illusion (Figure 9-16) is the false perception of distance from an object or the ground, created when a crew member misinterprets an unfamiliar object's size to be the same as an object that he is accustomed to viewing. This illusion can occur if the visual cues, such as a runway or trees, are of a different size than expected. An aviator making an approach to a larger, wider runway may perceive that the aircraft is too low. Conversely, an aviator—making an approach to a smaller, narrower runway—may perceive that the aircraft is too high. A pilot making an approach 25 feet above the trees in the State of Washington, where the average tree is 100 feet tall, may fly the aircraft dangerously low if trying to make the same approach at Fort Rucker, Alabama, where the average tree height is 30 feet. This illusion may also occur when an individual is viewing the position lights of another aircraft at night. If the aircraft being observed suddenly flies into smoke or haze, the aircraft will appear to be farther away than before.

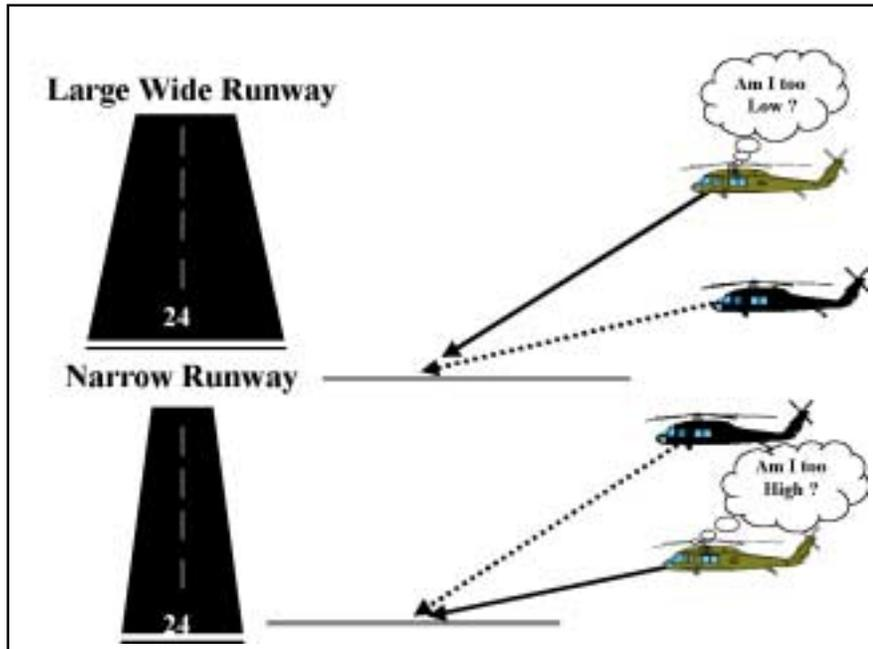

Figure 9-16. Size-Distance Illusion

### FASCINATION (FIXATION) IN FLYING

9-31. Fascination, or fixation, flying can be separated into two categories: task saturation and target fixation. Task saturation may occur during the accomplishment of simple tasks within the cockpit. Crew members may become so engrossed with a problem or task within the cockpit that they fail to properly scan outside the aircraft. Target fixation, commonly referred to as target hypnosis, occurs when an aircrew member ignores orientation cues and focuses his attention on his object or goal; for example, an attack pilot on a gunnery range becomes so intent on hitting the target that he forgets to fly the aircraft, resulting in the aircraft striking the ground, the target, or the shrapnel created by hitting the target.

### REVERSIBLE PERSPECTIVE ILLUSION

9-32. At night, an aircraft may appear to be moving away when it is actually approaching. If the pilot of each aircraft has the same assumption, and the rate of closure is significant, by the time each pilot realizes the misassumption, it may be too late to avoid a mishap. This illusion is termed reversible perspective and is often experienced when an aircrew member observes an aircraft flying a parallel course. In this situation, aircrew coordination is paramount. To determine the direction of flight, the aircrew member should observe the other aircraft's position lights. Remember the following: red on right returning; that is, if you see an aircraft with the red position light on the right and the green position light on the left, the observed aircraft is traveling in the opposite direction of your flight path.

### ALTERED PLANES OF REFERENCE

9-33. In altered planes of reference (Figure 9-17), the pilot has an inaccurate sense of altitude, attitude, or flight-path position in relation to an object so great in size that the object becomes the new plane of reference rather than the correct plane of reference, the horizon. A pilot approaching a line of mountains may feel the need to climb although the altitude of the aircraft is adequate. This is because the horizon, which helps the pilot maintain orientation, is subconsciously moved to the top of the ridgeline. Without an adequate horizon, the brain attempts to fix a new horizon. Conversely, an aircraft entering a valley that contains a slowly increasing up-slope condition may become trapped because the slope may quickly increase and exceed the ability of the aircraft to climb above the hill, causing the aircraft to crash into the surrounding hills.



Figure 9-17. Altered Planes of Reference

### AUTOKINESIS

9-34. Autokinesis primarily occurs at night when ambient visual cues are minimal and a small, dim light is seen against a dark background. After about 6 to 12 seconds of visually fixating on the light, one perceives movement at up to 20 degrees in any particular direction or in several directions in succession, although there is no actual displacement of the object. This illusion may allow an aviator to mistake the object fixated as another aircraft. In addition, a pilot flying at night may perceive a relatively stable lead aircraft to be moving erratically, when in fact, it is not. The unnecessary and undesirable control inputs that the pilot makes to compensate for the illusory movement of the aircraft represent increased work and wasted motion, at best, and an operational hazard at worst.

### FLICKER VERTIGO

9-35. Flicker vertigo (Figure 9-18) is technically not an illusion; however, as most people are aware from personal experience, viewing a flickering light can be both distracting and annoying. Flicker vertigo may be created by helicopter rotor blades or airplane propellers interrupting direct sunlight at a rate of 4 to 20 cycles per second. Flashing anticollision strobe lights,

especially while the aircraft is in the clouds, can also produce this effect. One should also be aware that photic stimuli at certain frequencies could produce seizures in those rare individuals who are susceptible to flicker-induced epilepsy.

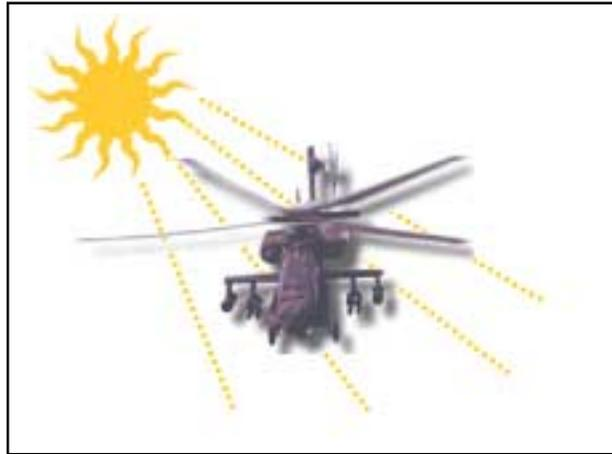

**Figure 9-18. Flicker Vertigo**

## **VESTIBULAR ILLUSIONS**

9-36. The vestibular system provides accurate information as long as an individual is on the ground. Once the individual is airborne, however, the system may function incorrectly and cause illusions. These illusions pose the greatest problem with spatial disorientation. Aircrew members must understand vestibular illusions and the conditions under which they occur. They must be able to distinguish between the inputs of the vestibular system that are accurate and those that cause illusion.

## **SOMATOGYRAL ILLUSIONS**

9-37. Somatogyral illusions are caused when angular accelerations and decelerations stimulate the semicircular canals. Those that may be encountered in flight are the leans, graveyard spin, and Coriolis illusions.

### **Leans**

9-38. The most common form of spatial disorientation is the leans. This illusion occurs when the pilot fails to perceive angular motion. During continuous straight-and-level flight, the pilot will correctly perceive that he is straight and level (part A, Figure 9-19). However, a pilot rolling into or out of a bank may experience perceptions that disagree with the reading on the attitude indicator. In a slow roll, for instance, the pilot may fail to perceive that the aircraft is no longer vertical. He may feel that his aircraft is still flying straight and level although the attitude indicator shows that the aircraft is in a bank (part B, Figure 9-19). Once the pilot detects the slow roll, he makes a quick recovery. He rolls out of the bank and resumes straight-and-level flight. The pilot may now perceive that the aircraft is banking in the opposite direction. However, the attitude indicator shows the

aircraft flying straight and level (part C, Figure 9-19). The pilot may then feel the need to turn the aircraft so that it aligns with the falsely perceived vertical position. Instead, the pilot should maintain straight-and-level flight as shown by the attitude indicator. To counter the falsely perceived vertical position, the pilot will lean his body in the original direction of the subthreshold roll until the false sensation leaves (part D, Figure 9-19).

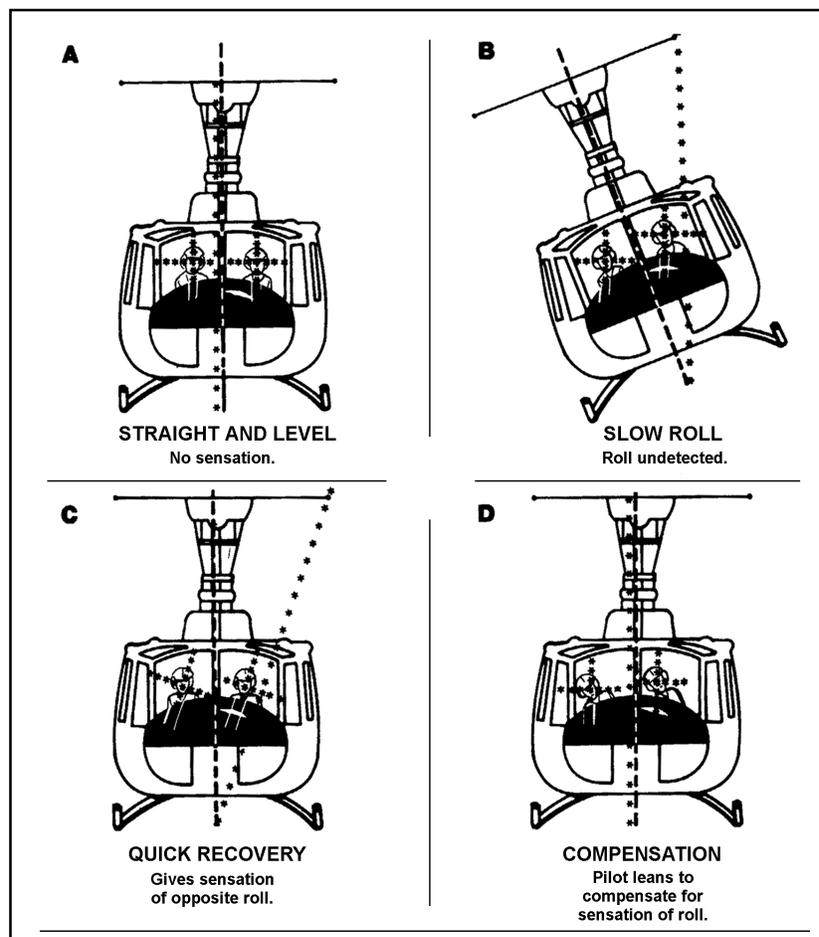
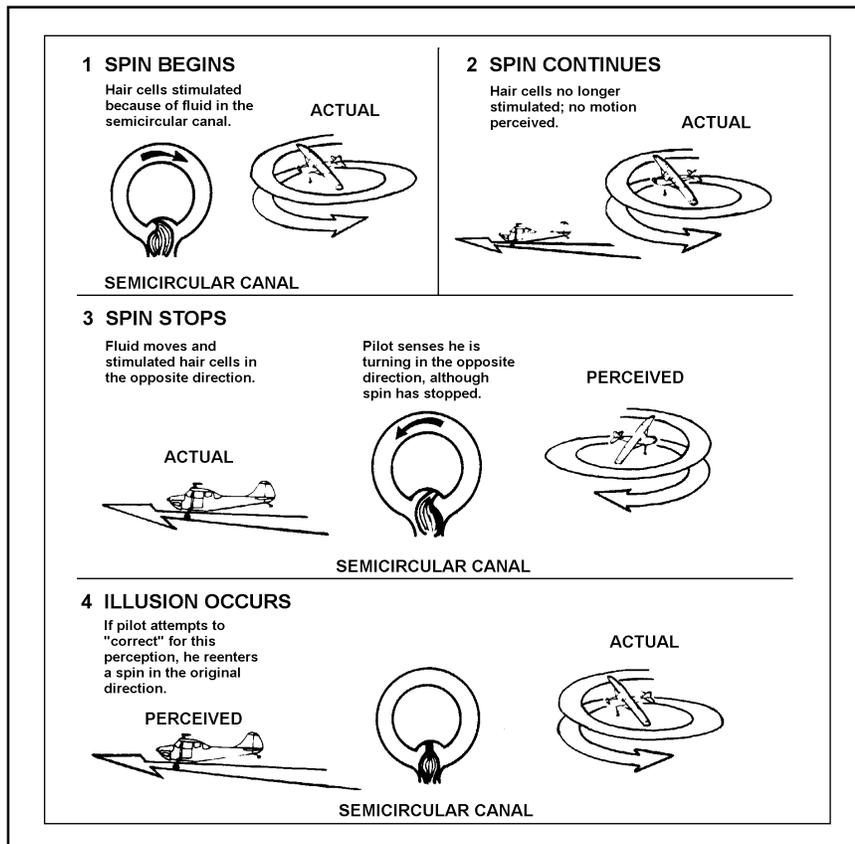

Figure 9-19. Leans

### Graveyard Spin

9-39. This illusion, shown in Figure 9-20, usually occurs in fixed-wing aircraft. For example, a pilot enters a spin and remains in it for several seconds. The pilot's semicircular canals reach equilibrium; no motion is perceived. Upon recovering from the spin, the pilot undergoes deceleration, which is sensed by the semicircular canals. The pilot has a strong sensation of being in a spin in the opposite direction even if the flight instruments contradict that perception. If deprived of external visual references, the pilot may disregard the instrumentation and make control corrections against the falsely perceived spin. The aircraft will then reenter a spin in the original direction.



**Figure 9-20. Graveyard Spin**

9-40. To compound the action of the semicircular canals under these conditions, a pilot, noting a loss of altitude as the spin develops, may apply back pressure on the controls and add power in an attempt to gain altitude. This maneuver tightens the spin and may cause the pilot to lose control of the aircraft.

### Coriolis Illusion

9-41. Regardless of the type of aircraft flown, the Coriolis illusion is the most dangerous of all vestibular illusions. It causes overwhelming disorientation.

9-42. This illusion occurs whenever a prolonged turn is initiated and the pilot makes a head motion in a different geometrical plane. When a pilot enters a turn and then remains in the turn, the semicircular canal corresponding to the yaw axis is equalized. The endolymph fluid no longer deviates, or bends, the cupula. Figure 9-21 shows the movement of the fluid in a semicircular canal when a pilot enters a turn.

9-43. If the pilot initiates a head movement in a geometrical plane other than that of the turn, the yaw axis semicircular canal is moved from the plane of rotation to a new plane of nonrotation. The fluid then slows in that canal, resulting in a sensation of a turn in the direction opposite that of the original turn.

9-44. Simultaneously, the two other canals are brought within a plane of rotation. The fluid stimulates the two other cupulas. The combined effect of the coupler deflection in all three canals creates the new perception of motion in three different planes of rotation: yaw, pitch, and roll. The pilot experiences an overwhelming head-over-heels tumbling sensation.

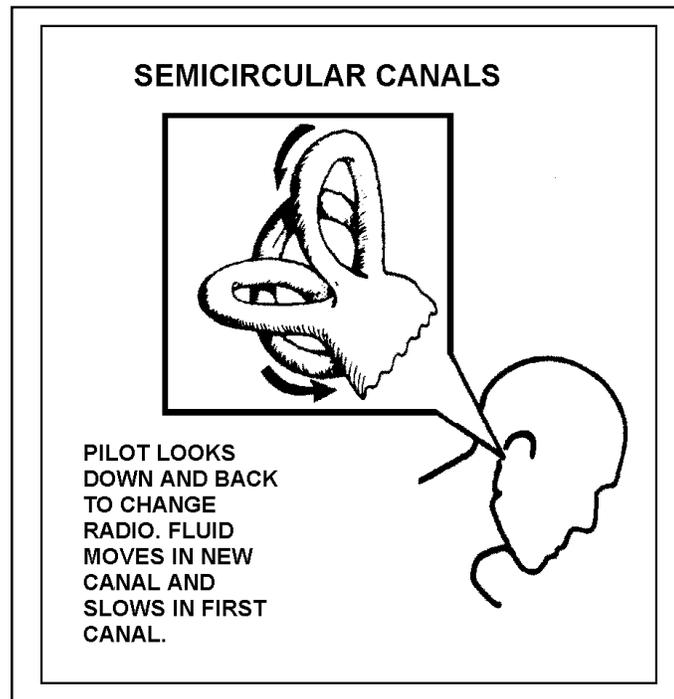

**Figure 9-21. Movement of Fluid in the Semicircular Canals During a Turn**

## **SOMATOGRAVIC ILLUSIONS**

9-45. Somatogravic illusions are caused by changes in linear accelerations and decelerations or gravity that stimulate the otolith organs. The three types of somatogravic illusions that can be encountered in flight are oculogravic, elevator, and oculoagravic.

### **Oculogravic Illusion**

9-46. This type of illusion occurs when an aircraft accelerates and decelerates. Inertia from linear accelerations and decelerations cause the otolith organ to sense a nose-high or nose-low attitude. In a linear acceleration, the gelatinous layer, which contains the otolith organ, is shifted aft. The aviator falsely perceives that the aircraft is in a nose-high attitude. A pilot correcting for this illusion without cross-checking the instruments would most likely dive the aircraft. This illusion does not occur if adequate outside references are available. If making an instrument approach in inclement weather or in darkness, the pilot would be considerably more susceptible to the oculogravic illusion. An intuitive reaction to the sensed nose-high attitude could have catastrophic results

### **Elevator Illusion**

9-47. This illusion occurs during upward acceleration. Because of the inertia encountered, the pilot's eyes will track downward as his body tries, through inputs supplied by the inner ear, to maintain visual fixation on the environment or instrument panel. With the eyes downward, the pilot will sense that the nose of the aircraft is rising. This illusion is common for aviators flying aircraft that encounter updrafts.

### **Oculoagravic Illusion**

9-48. This illusion is the opposite of the elevator illusion and results from the downward movement of the aircraft. Because of the inertia encountered, the pilot's eyes will track upward. The pilot's senses then usually indicate that the aircraft is in a nose-low attitude. This illusion is commonly encountered as a helicopter enters autorotation. The pilot's usual intuitive response is to add aft cyclic, which decreases airspeed below the desired level.

## **PROPRIOCEPTIVE ILLUSIONS**

9-49. Proprioceptive illusions rarely occur alone. They are closely associated with the vestibular system and, to a lesser degree, with the visual system. The proprioceptive information input to the brain may also lead to a false perception of true vertical. During turns, banks, climbs, and descending maneuvers, proprioceptive information is fed into the central nervous system. A properly executed turn vectors gravity and centrifugal force through the vertical axis of the aircraft. Without visual reference, the body only senses being pressed firmly into the seat. Because this sensation is normally associated with climbs, the pilot may falsely interpret it as such. Recovering from turns lightens pressure on the seat and creates an illusion of descending. This false perception of descent may cause the pilot to pull back on the stick, which would reduce airspeed. Figure 9-22 shows proprioceptive illusions.

## **PREVENTION OF SPATIAL DISORIENTATION**

9-50. Spatial disorientation cannot be totally eliminated. However, aircrew members need to remember that misleading sensations from sensory systems are predictable. These sensations can happen to anyone because they are due to the normal functions and limitations of the senses. Training, instrument proficiency, good health, and aircraft design minimize spatial disorientation. Spatial disorientation becomes dangerous when pilots become incapable of making their instruments read right. All pilots, regardless of experience level, can experience spatial disorientation. For that reason, they should be aware of the potential hazards, understand their significance, and learn to overcome them. To prevent disorientation, aviators should—

- Never fly without visual reference points (either the actual horizon or the artificial horizon provided by the instruments).
- Trust the instruments.

- Avoid fatigue, smoking, hypoglycemia, hypoxia, and anxiety, which all heighten illusions.
- Never try to fly VMC and IMC at the same time.

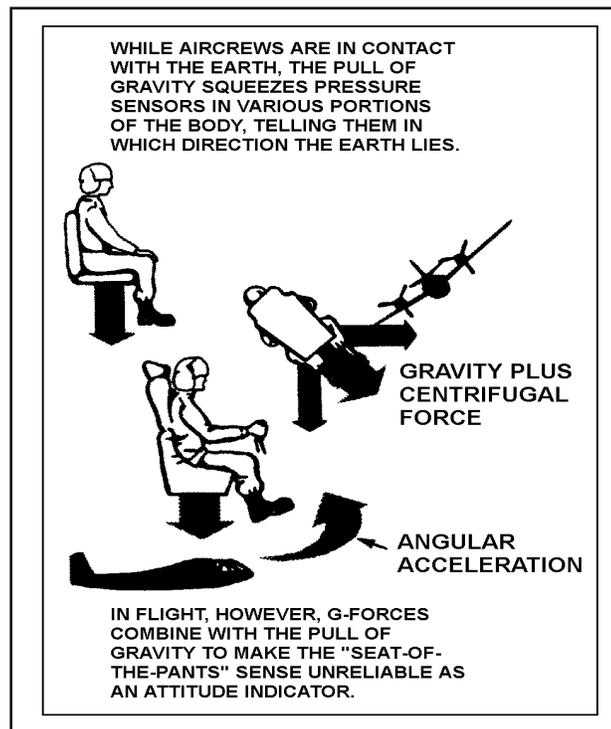

Figure 9-22. Proprioceptive Illusions

## TREATMENT OF SPATIAL DISORIENTATION

9-51. Spatial disorientation can easily occur in the aviation environment. If disorientation occurs, aviators should—

- Refer to the instruments and develop a good cross-check.
- Delay intuitive actions long enough to check both visual references and instruments.
- Transfer control to the other pilot if two pilots are in the aircraft. Rarely will both experience disorientation at the same time.

## Chapter 10

# Oxygen Equipment and Cabin Pressurization

With the technological advances of today's Army aircraft and the increase of operational requirements to conduct operations at altitudes exceeding 10,000 feet MSL, oxygen equipment and cabin pressurization are crucial. Without supplemental oxygen and cabin pressurization, crew members increase their risks of hypoxia, evolved-gas disorders, and decompression sickness. This chapter explains cabin pressurization and oxygen equipment and their use in Army aviation.

### OXYGEN SYSTEMS

10-1. Aircraft oxygen systems consist of containers that store oxygen either in a gaseous, liquid, or solid state; tubing to direct the flow; devices that control the pressure and the percentage of oxygen; and a mask to deliver oxygen to the user. The oxygen systems can exist in many forms throughout the military, but the following equipment is used in Army aircraft.

### GASEOUS OXYGEN

10-2. Aviator's gaseous oxygen is the most common breathing oxygen found in Army aircraft. It is classified as Type I, Grade A, and meets the military specifications in MIL-O-27210E. This form is 99.5 percent pure by volume and contains no more than 0.005 milligrams of water vapor per liter at 760 mm/Hg pressure and 15 degrees Celsius. Gaseous oxygen is odorless and free from contaminants.

10-3. The oxygen used for medical purposes is classified as Type I, Grade B, and is not acceptable for use by aviators because of its high moisture content. This is important because at high altitudes the temperature may cause freezing in the oxygen-delivery system and restrict the flow of oxygen.

### ONBOARD OXYGEN-GENERATING SYSTEM

10-4. The OBOGS is the primary method of providing oxygen to patients aboard the UH-60Q Black Hawk. The use of this system reduces many of the potential hazards associated with gaseous high-pressure systems. In addition, the service and maintenance of this system is simpler than other systems. Various onboard oxygen-generating systems have been tested, and some show great potential for future military use. The aircraft technical manual contains the specific capabilities of the OBOGS.

## **STORAGE SYSTEMS**

### **GASEOUS LOW-PRESSURE SYSTEM**

10-5. In this type of system, the breathing oxygen is stored in yellow, lightweight, shatterproof cylinders that contain a maximum charge pressure of 400 to 450 pounds per square inch. This system is not very effective because the low pressure limits the volume of oxygen that can be stored. In addition, if this system falls below 50 pounds per square inch, it must be recharged within two hours to prevent moisture condensation within the cylinder. If not recharged, the system must be purged before it is refilled. Low-pressure oxygen is commonly used during an emergency.

### **GASEOUS HIGH-PRESSURE SYSTEM**

10-6. This type of system is in use aboard most Army aircraft with internal storage systems. In this system, the breathing oxygen is stored in green heavyweight cylinders that contain a maximum charge pressure of 1,800 to 2,200 pounds per square inch. Large amounts of oxygen can be safely stored to meet the mission requirements of the Army's fixed-wing aircraft.

10-7. The H-2 bailout bottle is a gaseous high-pressure (1,800 to 2,000 pounds per square inch) system. It provides an emergency source of oxygen in case the aircraft oxygen system fails. It also provides high-altitude parachutists with a source of oxygen during a high-altitude jump. This system automatically activates during an ejection sequence or is manually activated by pulling the ball handle ("Green Apple"). Once this system is activated, it cannot be stopped. The bailout bottle provides about 10 minutes of breathing oxygen.

10-8. The helicopter oxygen system is a self-contained portable oxygen system that supplies oxygen to crew members on missions requiring oxygen at altitude. The HOS (Figure 10-1) is tailored for use in the UH-60, CH-47 (forward or aft), and the UH-1. It can also be used in other aircraft not listed, but additional supply hoses may be required. Each HOS can provide 100 percent oxygen to six personnel for one hour at altitudes up to 25,000 feet MSL. Oxygen is stored in two tandem-connected storage cylinders that have to be recharged by an oxygen servicing unit.

## **OXYGEN REGULATORS**

10-9. The flow of oxygen into the mask must be controlled when oxygen systems are used onboard aircraft. Two types of oxygen regulators are used in Army aircraft: diluter demand and continuous flow.

### **QUICK-DONNING MASK-REGULATOR**

10-10. A diluter-demand regulator wastes less oxygen than a continuous-flow regulator, fits better, and provides the user a high percentage of oxygen. A mask-regulator makes up the self-contained, quick-donning unit that is available for pilots who encounter pressurization problems within the cabin. Figure 10-2 shows this mask-regulator assembly unit.

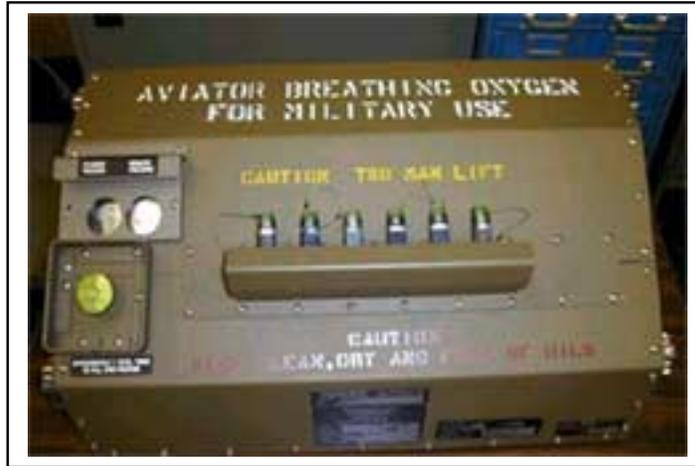

**Figure 10-1. Helicopter Oxygen System**



**Figure 10-2. Quick-Donning Mask-Regulator**

10-11. During each inhalation, negative pressure closes the one-way exhaust valve in the mask and opens the demand valve in the regulator. This provides an oxygen flow only on demand. This regulator can mix suitable amounts of ambient air and oxygen to prolong the oxygen source. When the diluter level is placed in the position marked "NORMAL," the breathing mixture at ground level is mainly ambient air with very little added oxygen. During ascent, an air inlet is partially closed by an aneroid pressure valve to provide a higher

concentration of oxygen. This inlet valve closes completely at 34,000 feet MSL, and the regulator then delivers 100 percent oxygen. On descent, this process reverses.

10-12. The regulator can also provide 100 percent oxygen when the diluter lever is placed in the position marked "100% OXYGEN" at any altitude. The diluter level is set on "NORMAL" for routine operations; it is placed on "100% OXYGEN" when hypoxia is suspected or prebreathing is required.

### **CONTINUOUS-FLOW OXYGEN REGULATOR**

10-13. Continuous-flow oxygen systems provide protection for passengers up to 25,000 feet MSL and provide a continuous flow of 100 percent oxygen to the user. The three major types of regulators in this system are manual, automatic, and automatic with manual override.

### **OXYGEN MASKS**

10-14. Three main oxygen masks used by the Army's aviation community are the passenger, MBU-12/P, and diluter-demand quick-don mask. Except for the passenger mask, which is a continuous-flow mask, oxygen masks are pressure-demand masks. The continuous-flow mask supplies oxygen continuously to the user; the pressure-demand mask allows oxygen to enter the mask only when the user inhales. The oxygen in the mask is then maintained at a positive pressure until the regulator pressure is overcome during exhalation.

### **PASSENGER OXYGEN MASK**

10-15. The passenger mask, found onboard Army fixed-wing aircraft, supplies a continuous flow of oxygen whether the users are inhaling or not. The mask (Figure 10-3) plugs into receptacles within the passenger compartment.

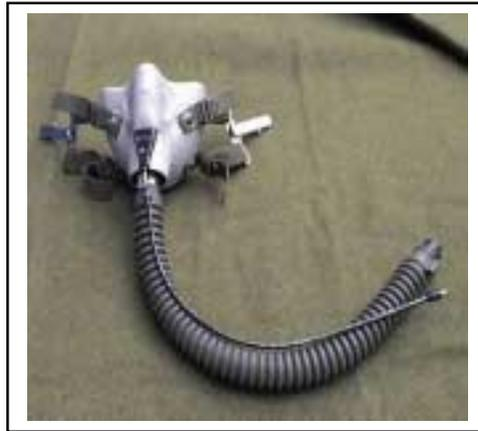

**Figure 10-3. Passenger Oxygen Mask**

### **MBU-12/P OXYGEN MASK**

10-16. The MBU-12/P mask (Figure 10-4) comes in four sizes: short, regular, long, and extra long. To ensure a proper fit, individuals should wear a mask in the size that most nearly matches their facial measurements.

10-17. The MBU-12/P oxygen mask consists of a silicone rubber inner face piece, bonded to the hard shell to form a one-piece assembly. The MBU-12/P is an improvement over previous masks; it is more comfortable, fits better, and offers increased downward vision.



**Figure 10-4. MBU-12/P Oxygen Mask**

### **OXYGEN-EQUIPMENT CHECKLIST**

10-18. Because oxygen equipment can easily malfunction, it must be checked continually. Aircrew members check their oxygen system equipment using the appropriate checklist or technical manual.

### **CABIN PRESSURIZATION**

10-19. The Army's fixed-wing aircraft can fly at higher altitudes than crew members can physiologically tolerate. Therefore, cabin pressurization was developed for the safety and comfort of crew members and passengers.

### **SYSTEM OF CABIN PRESSURIZATION**

10-20. The most efficient method for protecting crew members flying at altitude is to increase the barometric pressure inside the cabin area so that it is greater than the ambient pressure outside. In high-altitude flight without pressurization, crew members require continual use of oxygen equipment. Continual use increases crew fatigue. Pressurization, however, does have disadvantages. If crew members encounter problems with cabin pressurization, they may suffer serious physiological impairment.

10-21. Because greater pressure must exist inside the cabin than outside, the aircraft wall must be structurally reinforced to contain this pressure. This reinforcement increases the design and maintenance costs of the aircraft, and the added weight and increased power requirements reduce its performance.

10-22. Cabin pressurization is achieved by extracting outside ambient air, forcing it through compressors, cooling it, and maintaining it at a given cabin altitude. Pressurization is maintained by controlling the amount of air that is allowed to escape in relation to the air that is compressed. In the typical cabin pressurization system, the controls sense changes in both cabin and outside ambient air pressure and make the necessary adjustments to maintain the cabin pressure at a fixed pressure differential. (This differential is the difference between the cabin pressure and the outside ambient air pressure.) A cabin altimeter, usually part of the pressurization system, allows the pilot to observe the cabin altitude and make the required cabin pressure changes.

10-23. The cabin altitude on most aircraft usually increases with aircraft altitude until an altitude of 5,000 to 8,000 feet is reached. Barometric control then maintains the cabin at that set altitude until the maximum pressure differential for the aircraft is reached.

10-24. From sea level to 20,000 feet MSL, a barometric controller modulates the outflow of air from the cabin to maintain a selected cabin rate of climb. Cabin altitude increases until the maximum cabin pressure differential of 6.0 pounds per square inch is reached. Thus, below an altitude of 20,000 feet MSL, a cabin pressure altitude of 3,870 feet MSL can be maintained.

10-25. From 20,000 to 31,000 feet MSL (the service ceiling of the C-12D), the maximum pressure differential is maintained; however, the cabin altitude will increase (Figure 10-5). At 31,000 feet MSL and a pressure differential of 6.0 pounds per square inch, a cabin altitude of 9,840 feet MSL is reached.

10-26. The cabin pressurization selected for a particular aircraft is usually a compromise among physiological requirements, engineering capability, overall aircraft performance, and cost.

### **ADVANTAGES OF CABIN PRESSURIZATION**

10-27. For aircraft capable of flight above 20,000 feet MSL, cabin pressurization has several advantages. In general, pressurization will—

- Eliminate the need for supplemental-oxygen equipment.
- Reduce significantly the occurrences of hypoxia and decompression sickness.
- Minimize trapped-gas expansion.
- Reduce crew fatigue because cabin temperature and ventilation can be controlled within desired ranges.

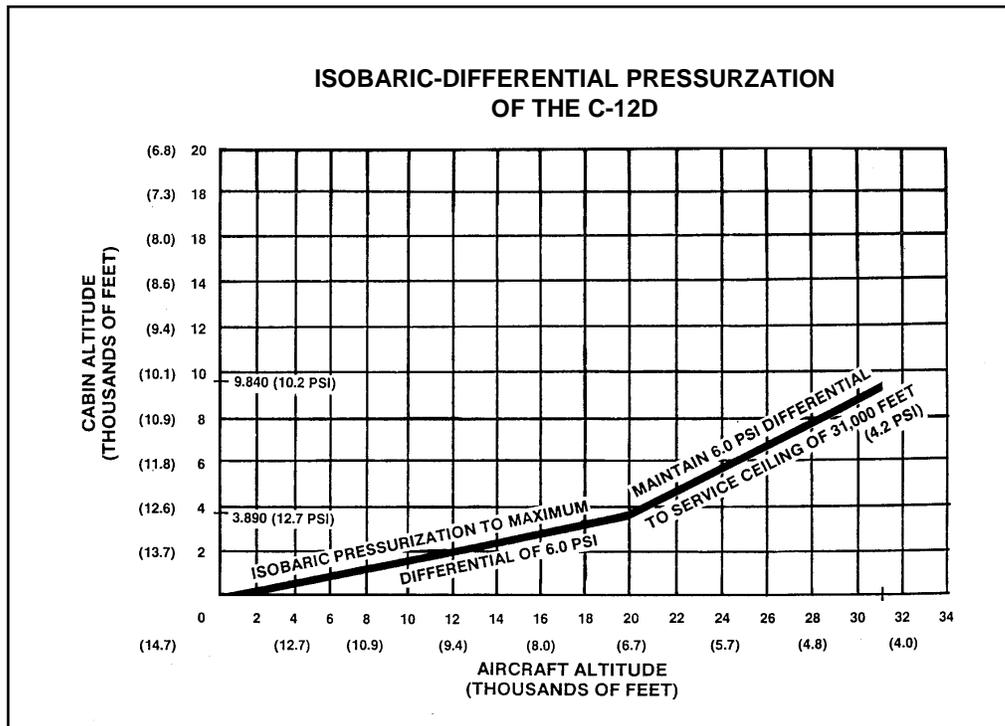

Figure 10-5. C-12D Cabin Pressurization Changes With Altitude Changes

## LOSS OF CABIN PRESSURIZATION

10-28. Failure of the pressurization system and the resulting decompression can produce significant physiological problems for crew members. Slow decompression of the cabin, although dangerous because of the slow and insidious onset of hypoxia, is not as physiologically dangerous as rapid decompression. A rapid decompression occurs when the fuselage or pressure vessel is compromised and the cabin pressure equalizes almost instantaneously with outside ambient pressure.

10-29. The following factors control the rate and time of decompression:

- **Volume of the pressurized cabin.** The larger the cabin area, the slower the decompression time.
- **Size of the opening.** The larger the opening, the faster the decompression.
- **Pressure differential.** The larger the pressure differential between the outside absolute pressure and the interior cabin pressure, the more severe the decompression.
- **Pressure ratio.** The greater the difference between inside and outside pressures of the cabin, the longer the time for air to escape and the longer the decompression time.

10-30. The physiological effects of a rapid decompression range from trapped-gas expansion—within the ears, sinuses, lungs, and abdomen—to

hypoxia. The gas-expansion disorders can be painful and may become severe, but they are transient. The most serious hazard for the aircrew member is hypoxia. The onset of hypoxia can be rapid, depending on the cabin altitude after the decompression. For the average individual, the EPT is decreased by half following a rapid decompression. Crew members may also experience decompression sickness, cold, and windchill.

### **INDICATIONS OF RAPID DECOMPRESSION**

10-31. The rapidity of the decompression determines the magnitude of the observable characteristics of decompression. The earlier that crew members detect a loss of pressure, the quicker that they can take appropriate emergency measures to increase survival. All of the following observable characteristics may indicate loss of pressure.

#### **Noise**

10-32. Anytime two different air masses make contact, there is a loud, popping noise. This explosive sound is often called “explosive decompression.”

#### **Flying Debris**

10-33. Crew members need to be alert to the possibility of flying debris during a rapid decompression. The rush of air from inside an aircraft structure to the outside is of such force that items not secured may be ejected from the aircraft.

#### **Fogging**

10-34. The sudden loss of pressure causes condensation and the resulting fog effect. Fogging is one of the primary characteristics of any decompression because air at a given temperature and pressure can hold only so much water vapor.

#### **Temperature**

10-35. With a loss of pressurization, cabin temperature equalizes with the outside ambient temperature, which significantly decreases cabin temperature. The amount of temperature decrease depends on altitude.

### **IMMEDIATE ACTIONS FOLLOWING DECOMPRESSION**

10-36. After cabin decompression occurs, all crew members and passengers should breathe supplemental oxygen. Immediate descent should be made to an altitude that will minimize the physiological effects of the pressure loss.

## Appendix

# Hypobaric Chamber Flight Profiles

### MEDICAL CLEARANCE

A-1. All personnel must have a current flight physical and a current DA Form 4186 (Medical Recommendation for Flying Duty) indicating FFD before participating in any hypobaric chamber exercise.

### PURPOSE OF HYPOBARIC TRAINING

A-2. The purpose of hypobaric chamber training is to safely demonstrate—

- Crew-member limitations associated with hypoxia at altitude.
- Effects of trapped-gas problems on the body.
- Effects of hypoxia on night vision.
- Capabilities of oxygen equipment.

### CHAMBER PROFILES AND APPLICABILITY OF TRAINING

A-3. Figures A-1 through A-5 show the standard flight chamber profiles. For information regarding nonstandard profiles, contact USASAM, ATTN MCCS-HA, Fort Rucker, Alabama 36362-5377.

A-4. The procedures for the profile in Figure A-1 are as follows:

- Begin 30-minute denitrogenation.
- Perform 5,000-foot ear and sinus check by 2,500 feet per minute.
- Ascend main accumulator, and lock to 8,000 feet by 2,500 feet per minute.
- Ascend main accumulator, and lock to 18,000 feet by 5,000 feet per minute.
- Perform running break of main accumulator and lock; maintain lock at 18,000 feet.
- Continue main accumulator ascent to 35,000 feet by 5,000 feet per minute.
- Descend main accumulator to 30,000 feet for 90-second hypoxia demonstration.
- Descend main accumulator, and lock to 25,000 feet by 5,000 feet per minute.
- Begin five-minute hypoxia demonstration.
- Descend lock to ground level by 5,000 feet per minute.

- Descend main accumulator to 18,000 feet by 5,000 feet per minute for night-vision demonstration.
- Descend main accumulator from 18,000 feet to ground level by 2,500 feet per minute.
- Terminate chamber flight.

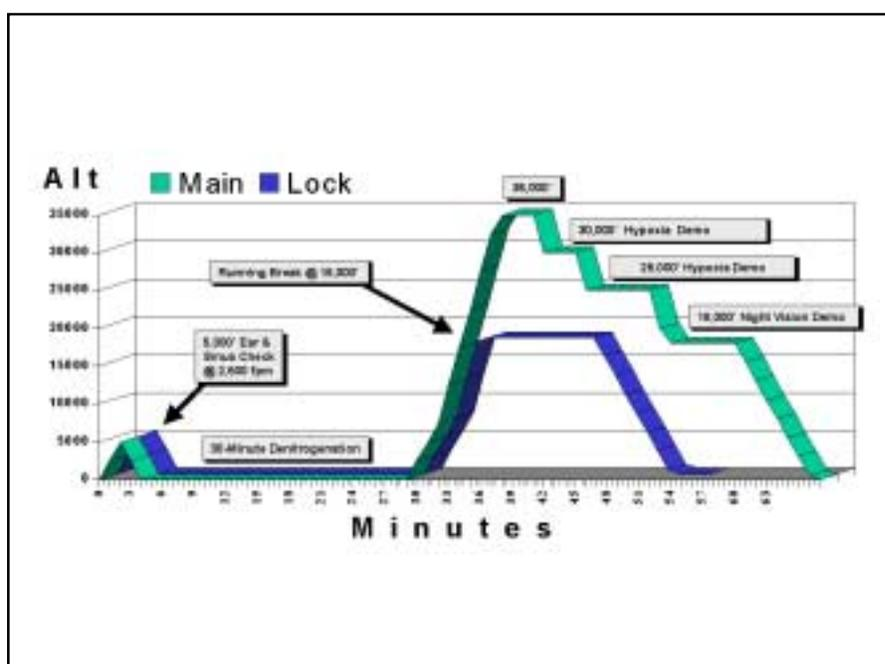

Figure A-1. Type II 35,000-Foot USAF Original Training Profile

A-5. The procedures for the profile in Figure A-2 are as follows:

- Begin 30-minute denitrogenation.
- Perform 5,000 feet ear and sinus check by 2,500 feet per minute.
- Ascend main accumulator from ground level to 8,000 feet by 2,500 feet per minute.
- Ascend main accumulator from 8,000 feet to 25,000 feet by 5,000 feet per minute.
- Begin five-minute hypoxia demonstration.
- Descend main accumulator from 25,000 feet to 18,000 feet by 5,000 feet per minute for night-vision demonstration.
- Descend main accumulator from 18,000 feet to ground level by 2,500 feet per minute.
- Terminate chamber flight.

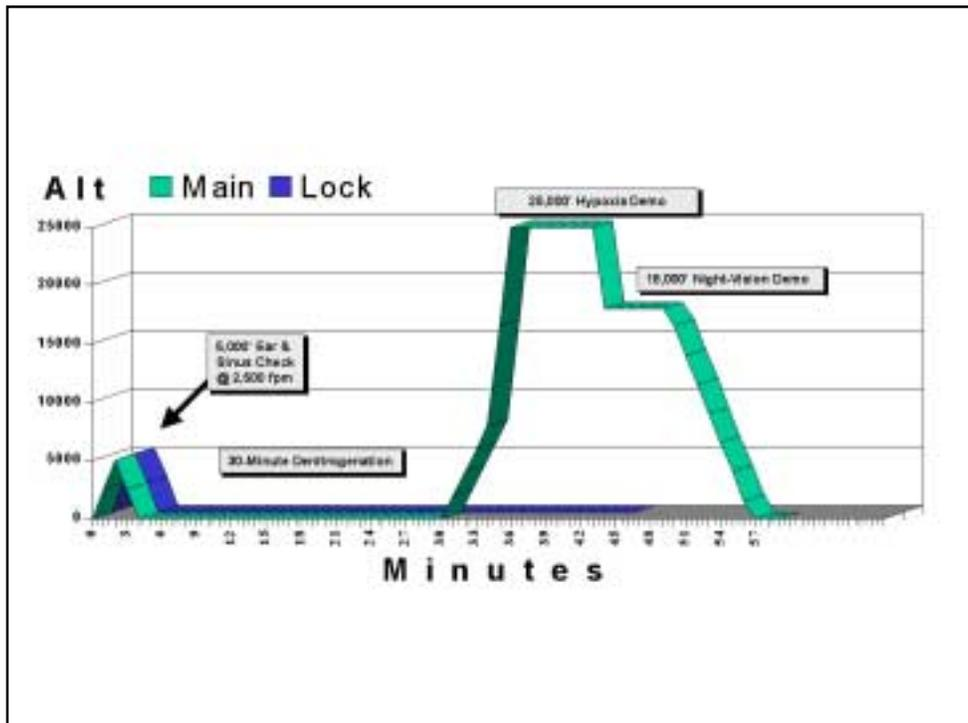
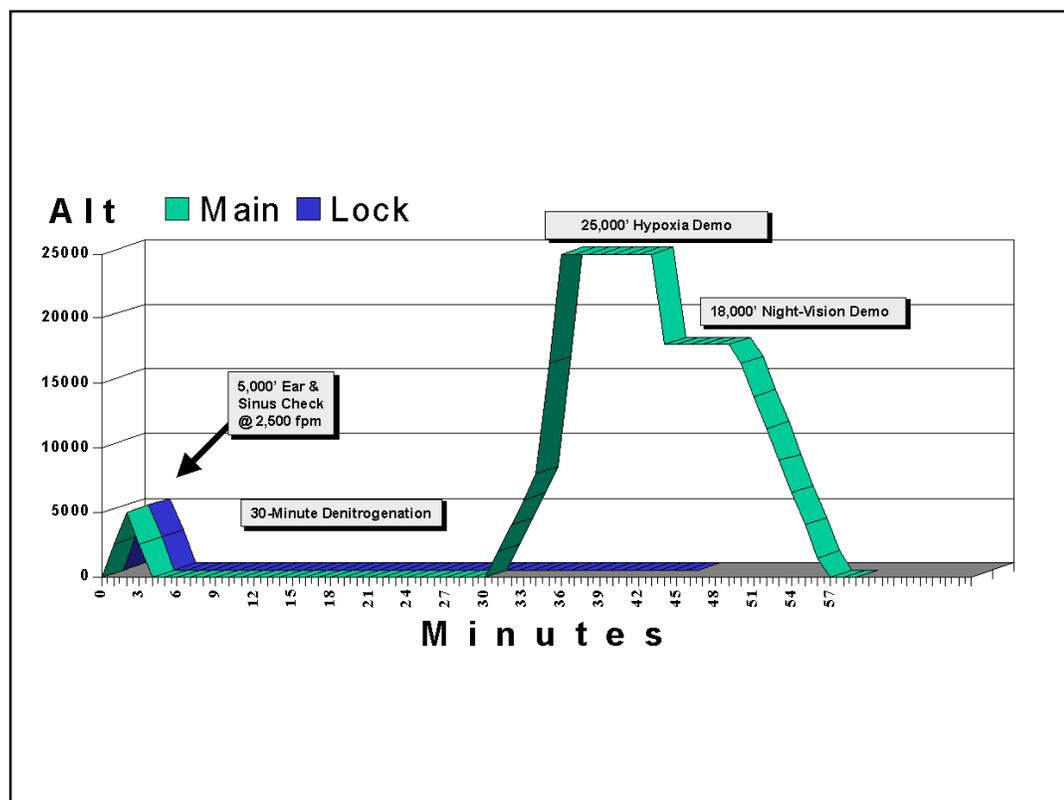

Figure A-2. Type IV, 25,000-Foot, USAF Refresher Training Profile

A-6. The procedures for the profile in Figure A-3 are as follows:

- Begin 30-minute denitrogenation.
- Perform 5,000-foot ear and sinus check by 2,500 feet per minute.
- Ascend main accumulator from ground level to 8,000 feet by 2,500 feet per minute.
- Ascend main accumulator from 8,000 feet to 25,000 feet by 5,000 feet per minute.
- Begin five-minute hypoxia demonstration.
- Descend main accumulator from 25,000 feet to 18,000 feet by 5,000 feet per minute for night-vision demonstration.
- Descend main accumulator from 18,000 feet to ground level by 2,500 feet per minute.
- Terminate chamber flight.



**Figure A-3. Type IV, 25,000-Foot, USA Profile**

A-7. The procedures for the profile in Figure A-4 are as follows:

- Begin 30-minute denitrogenation.
- Perform 5,000-foot ear and sinus check by 5,000 feet per minute.
- Ascend main accumulator, and lock to 18,000 feet by 5,000 feet per minute.
- Perform running break of main accumulator, and lock; maintain lock at 18,000 feet.
- Continue main accumulator ascent to 35,000 feet by 5,000 feet per minute.
- Ascend main accumulator to 30,000 feet for 90-second hypoxia demonstration.
- Descend main accumulator to 15,000 feet by 10,000 to 12,000 feet per minute, with lock joining descent at 18,000 feet.
- Descend main accumulator, and lock to 8,000 feet by 5,000 feet per minute.
- Ascend main accumulator to 25,000 feet by maximum rate of ascent.
- Begin five-minute hypoxia demonstration.
- Descend lock to ground level by 5,000 feet per minute.

- Descend main accumulator to 18,000 feet by 5,000 feet per minute for night-vision demonstration.
- Descend main accumulator from 18,000 feet to ground level by 2,500 feet per minute.
- Terminate chamber flight.

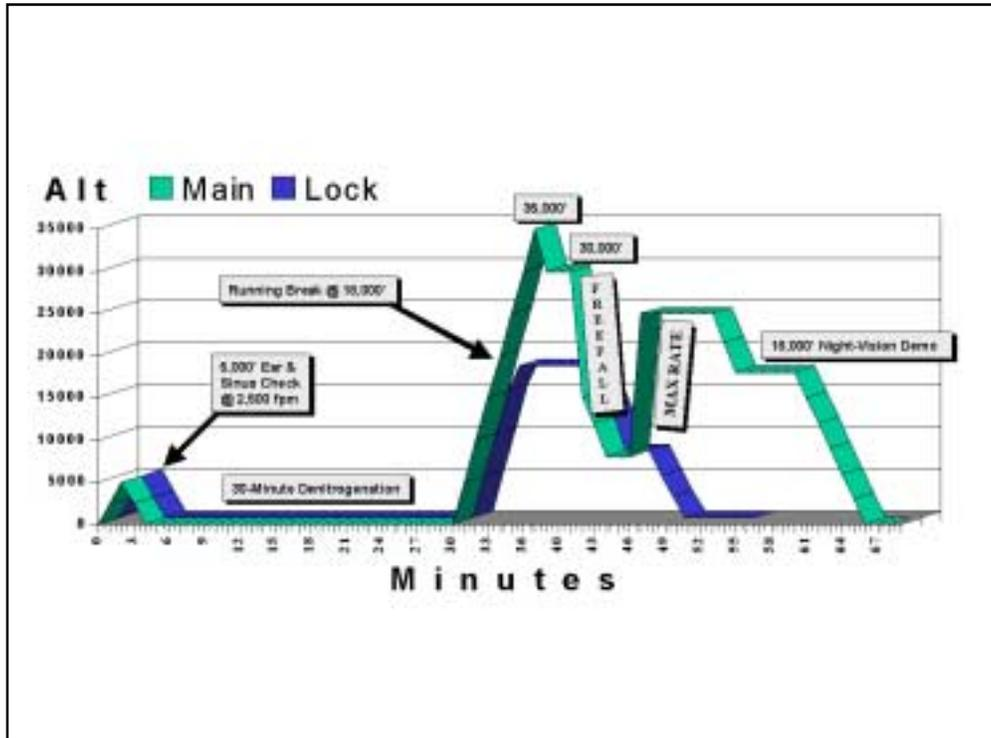

Figure A-4. Type V, 35,000-Foot, USA/USAF HAP

- A-8. The procedures for the profile in Figure A-5 are as follows:
- Ascend main accumulator to 32,500 feet by maximum rate.
  - Ascend lock to 8,000 feet by 2,500 feet per minute.
  - Perform rapid decompression.
  - Main accumulator and lock equalize at 22,500 feet.
  - Descend main accumulator; lock to 18,000 feet by 5,000 feet per minute, then from 18,000 feet to ground level by 2,500 feet per minute.

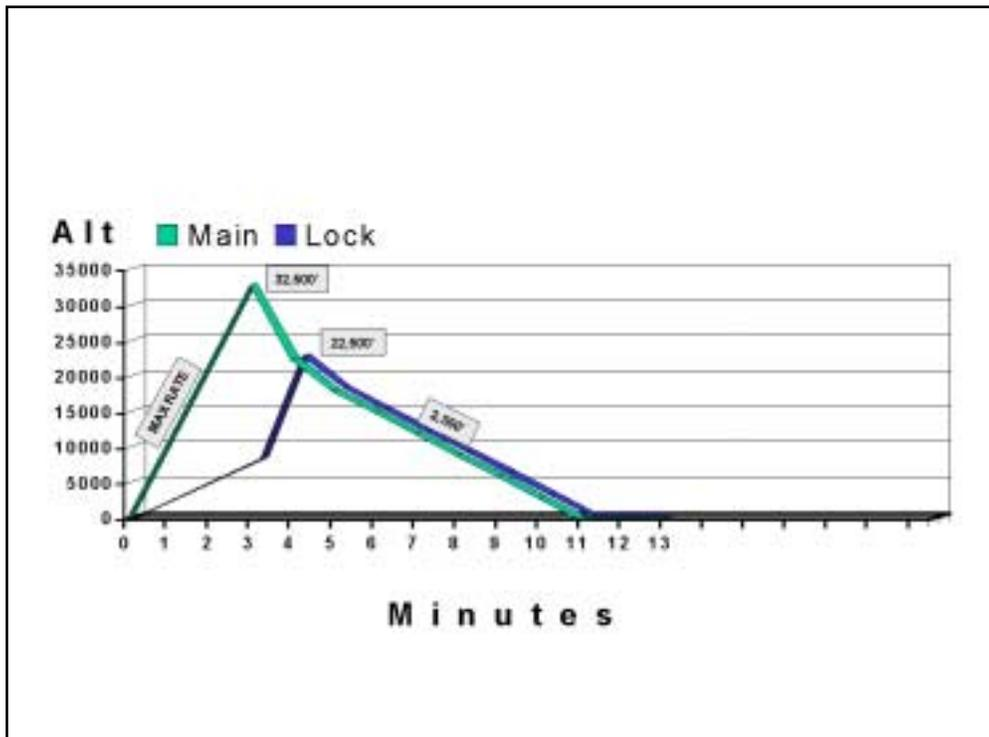

Figure A-5. Military Rapid Decompression Profile

## Glossary

<b>A</b>	argon
<b>absorption</b>	a process in which an object collects other materials within itself. Two examples of absorption are a sponge absorbing water and the tissues of the middle ear absorbing oxygen from the middle ear cavity.
<b>acceleration</b>	a change of velocity in magnitude or direction. It is expressed in feet per second per second, or $\text{fps}^2$ . The most common accelerative force is gravity. The acceleration produced by gravity is a constant and has a value of $32.2 \text{ fps}^2$ .
<b>acclimatization</b>	the physiological adjustment of an organism to a new and physically different environment. An example would be the adaptation of valley dwellers to life in mountainous regions where ambient pressures are relatively low. In this example, acclimatization would occur through a temporary adjustment in cardiac and respiratory rates and an increase in the number of red blood cells in the blood.
<b>ACPM</b>	aircrew protective mask
<b>acute</b>	an incident or disease characterized by sharpness or severity. It has a sudden onset, sharp rise, and short course. In physiological training, this term usually describes a severe chamber reaction in which the onset is rapid and immediate aid is required.
<b>AD</b>	Dictionary of United States Army Terms (short title)
<b>AF</b>	Air Force (USAF)
<b>AFFF</b>	aqueous film-forming foam
<b>AFP</b>	Air Force pamphlet
<b>AFR</b>	Air Force regulation
<b>AGARD</b>	Advisory Group for Aerospace Research and Development
<b>AGL</b>	above ground level
<b>AGSM</b>	anti-G straining maneuver
<b>AH</b>	attack helicopter
<b>AHO</b>	above highest obstacle
<b>alkalosis</b>	the term used by physiological training personnel to refer to a respiratory condition in which there is an increase in the basicity of the blood produced by the abnormally rapid respiration and elimination of excessive amounts of carbon dioxide.
<b>ALSE</b>	aviation life-support equipment

---

<b>alt</b>	altitude
<b>altimeter</b>	an instrument used to measure the altitude of an aircraft or chamber. By making appropriate adjustments and pressure settings, the altimeter may be set to indicate the pressure altitudes such as are used in chamber operations or the true altitudes used during most Army aircraft flights.
<b>altitude sickness</b>	in acute cases, the symptoms of hypoxia seen especially in flying personnel and in individuals who are new arrivals in mountainous regions of high altitude; in chronic cases, the symptoms of hypoxia usually seen in individuals who have been at high altitudes in mountainous regions for long periods. Apparently, their physiological compensatory processes for hypoxia become inadequate. Descent to lower altitudes usually brings relief.
<b>alveoli</b>	the saclike, extremely thin-walled tissues of the lungs in which the flow of the inspired gases terminates and across the walls of which gas diffusion takes place between the lungs and the blood.
<b>ambient</b>	the existing and adjacent environment. Ambient air pressure is the pressure of the immediate environment.
<b>angular acceleration</b>	acceleration that results in a simultaneous change in both speed and direction.
<b>anoxia</b>	a total absence of oxygen in the blood presented to the tissues or the inability of the tissues to use the oxygen delivered to them. This is an extremely severe and morbid condition. The lack of oxygen with which physiological training personnel are concerned is, strictly speaking, hypoxia, not anoxia.
<b>AR</b>	Army regulation
<b>arterial saturation</b>	the hemoglobin in the arterial blood containing as much oxygen as it can hold. This gives an arterial oxygen concentration of about 20 milliliters of oxygen per 100 milliliters of blood.
<b>arteries</b>	the blood vessels that possess relatively thick, muscular walls that transport oxygenated blood from the left ventricle to the body tissues. They also transport poorly oxygenated blood from the right ventricle to the lungs.
<b>arterioles</b>	the smaller extensions of the arteries. The muscular walls of these arterial extensions are responsive to nerve and chemical control by the body and thereby regulate the amount of blood presented to the capillaries.
<b>astigmatism</b>	a visual problem caused by an unequal curvature of the cornea or lens of the eye.
<b>ATM</b>	aircrew training manual
<b>ATP</b>	aircrew training plan
<b>atmosphere</b>	the gaseous layer surrounding the earth that is composed primarily of oxygen and nitrogen.

<b>attenuation</b>	the amount of noise protection provided by a specific protective device. The attenuation of any given noise protective device is the number of decibels it reduces the total energy reaching the eardrum.
<b>attn</b>	attention
<b>auricles (atria)</b>	the upper two chambers of the heart, designated the right and left auricles. These chambers receive blood from the vessels and force it into the ventricles.
<b>autokinesis</b>	an illusion in which a single, stationary point of light seen against a dark background appears to move erratically. The illusion is probably caused by the involuntary movement of the eyeballs because relative points of reference are missing.
<b>AVGAS</b>	aviation gasoline
<b>AWR</b>	airworthiness release
<b>barodontalgia (aerodontalgia)</b>	a toothache that occurs during ascent to altitude or during descent. Causes for this painful condition include poor or loose restorations; presence of decay, infection, or abscess; or gritting of the teeth in times of stress.
<b>barometer</b>	an instrument used to measure atmospheric pressure. It is based on the principle that the pressure exerted by the ambient air is sufficient to hold up a column of mercury. The height to which this column is held varies directly with the air pressure. The aneroid barometer operates on the principle that the volume of gas in a flexible, enclosed space will increase when the pressure on it decreases; for example, during ascent to altitude.
<b>barometric pressure</b>	the pressure of the air in a particular environment as measured by the barometer. For example, at 18,000 feet in the altitude chamber, the barometric pressure should be 380 mm/Hg.
<b>barotitis media</b>	a condition that develops when equalization of pressure in the middle ear cannot be accomplished during changes in barometric pressure.
<b>bends</b>	A form of decompression sickness that may be produced by the liberation of gaseous emboli (bubbles), primarily nitrogen, in the tissues of the body. It is characterized by mild to incapacitating pains in the joints. It may be localized to a single area (for example, knee joint or finger joint); or, in severe cases, it may be generalized.
<b>blackout</b>	a temporary blindness caused by an extinguished blood supply to the retina. Blackouts are usually seen during +Gz maneuvers. In such cases, the force exerted on the column of blood going to the eyes reduces the effective blood pressure in the vessels that go to the eyes, thereby reducing blood flow to the eyes. If continued, the force will actually stop the flow of blood to the retina.
<b>B-LP</b>	ballistic and laser protective (eyewear)

---

<b>Boyle's Law</b>	the physical law that states that the volume of a gas is inversely proportional to the pressure exerted upon it.
<b>bronchi</b>	the two main tubes leading into the lungs from the trachea. They are part of the conducting portion of the respiratory system.
<b>bronchioles</b>	the smaller tubules extending from each bronchus. Two types of bronchioles may be distinguished: the <i>conducting</i> bronchioles that provide the air passageway into the portion of the lungs where diffusion occurs and the <i>respiratory</i> bronchioles that contain some alveoli in their walls through which the diffusion of gases occurs.
<b>C</b>	Celsius
<b>calorie</b>	the amount of heat needed to raise the temperature of 1 gram of water from 250 degrees Celsius to 260 degrees Celsius.
<b>capillaries</b>	the most minute blood vessels. Their walls are of one-cell thickness. These vessels are the link between the arteries and veins; through them, gas diffusion takes place between the body tissues and the blood.
<b>cardiac arrhythmia</b>	any variation from the normal rhythm of the heart.
<b>cataract formation</b>	a clouding or opacification of the lens resulting from hardening of the lens that usually occurs during the aging process.
<b>CB</b>	chlorobromomethane
<b>CCl<sub>4</sub></b>	carbon tetrachloride
<b>centrifugal force</b>	the force exerted on an object moving in a circular pattern. It causes the object to break away and move outward in a straight line.
<b>centripetal force</b>	the force acting on an object moving in a circular pattern that holds the object on its circular path.
<b>CEP</b>	communications earplug
<b>CH</b>	cargo helicopter
<b>chemoreceptors</b>	the receptors adapted for excitation by chemical substances; for example, aortic and carotid bodies that sense reduced O <sub>2</sub> content in the blood and automatically send signals to the cardiovascular and respiratory systems to make necessary adjustments.
<b>chill factor</b>	the temperature decrease resulting from wind velocity. An increased cooling of exposed skin occurs when the skin is subjected to wind.
<b>chloride shift</b>	the passage of chloride ions from plasma into the red blood cells when carbon dioxide enters the plasma from the tissues and the return of these ions to the plasma when carbon dioxide is discharged in the lungs.
<b>chokes</b>	a form of decompression sickness that can occur at altitude. It is believed to be caused by gases evolving in the lung tissue. It is

---

	characterized by a deep substernal pain or burning sensation, difficulty in breathing, and a nonproductive cough.
<b>chronic</b>	a continued or prolonged condition; for example, a chronic illness would be an illness continuing for several years.
<b>cilium</b>	a minute, vibratile, hairlike process attached to the free surface of a cell.
<b>circadian rhythm</b>	the rhythmic biologic functions that are geared to an internal "biologic clock." Circadian rhythm affects such things as the sleep-wake cycle, hormone production, and body temperature.
<b>circulation</b>	the blood movement throughout the body.
<b>CNS</b>	central nervous system
<b>CO</b>	carbon monoxide
<b>CO<sub>2</sub></b>	carbon dioxide
<b>CoHb</b>	carboxyhemoglobin (found in the blood as a result of carbon monoxide inhalation)
<b>coma</b>	a state of complete loss of consciousness from which the patient cannot be aroused despite the use of powerful stimulants.
<b>combustion</b>	an act or instance of burning; a chemical process (as an oxidation) accompanied by the emission of heat and light.
<b>conduction</b>	the heat transfer between molecules of adjacent bodies or in a single body. Heat flows from a body or a portion of a body with a lower heat content; for example, heat transfer from the hand to an ice cube. Physical contact is necessary for heat transfer by conduction.
<b>cones</b>	the nerve cells in the central portion of the retina. Their greatest concentration is at the fovea. These cells are used for day vision and permit a person to see detail and to distinguish between various colors.
<b>conjunctiva</b>	the mucous membrane lining the inner surface of the eyelids and covering the front part of the eyeball.
<b>CONOPS</b>	continuous operations
<b>continuous flow</b>	the earliest supplementary oxygen-breathing system designed for use in aircraft. It is still used today in certain transport aircraft and for air evacuation. This system provides a constant flow of oxygen to the mask.
<b>contrast sensitivity</b>	the ability to detect objects on varying shades of backgrounds.
<b>convection</b>	a form of heat transfer effected by the flow of fluid across an object of a different temperature. If the object is warmer, the heat will transfer from the object to the liquid or gas; if the object is cooler, the heat will transfer from the liquid or gas to the object.

---

<b>convulsion</b>	a violent, involuntary contraction or series of contractions of voluntary muscles. This can occasionally be seen in hypoxic individuals or in people who have hyperventilated.
<b>Coriolis illusion</b>	a condition that exists when the head is moved from one plane to another while the body is in rotation. This causes an illusion of moving in a plane or rotation in which no angular motion exists.
<b>cornea</b>	the transparent part of the coat of the eyeball that covers the iris and pupil and admits light to the interior.
<b>counterpressure</b>	the pressure exerted on the outside of the body to balance the high pressure of the gases in the lungs.
<b>CREEP</b>	container, restraint system, environment, energy absorption, postcrash protection (aircraft design features that aid crash survival).
<b>cyanosis</b>	the blueness of the skin caused by insufficient oxygenation of the blood. Blood that has most of its hemoglobin combined with oxygen appears bright red, whereas blood with low oxygenated hemoglobin appears reddish-blue or cyanotic.
<b>DA</b>	Department of the Army
<b>Dalton's Law</b>	the physical law that states that the total pressure of a mixture of gases is equal to the sum of the partial pressures of each of the gases in that mixture.
<b>dark adaptation</b>	the process by which the retinal cells (rods) increase their concentration of the chemical substance (rhodopsin) that allows them to function optimally in twilight or in dimly illuminated surroundings. The process takes between 30 and 45 minutes in a darkened room.
<b>DB</b>	dibromodifluoromethane
<b>dB</b>	decibel
<b>DCS</b>	decompression sickness
<b>DEATH</b>	drugs, exhaustion, alcohol, tobacco, and hypoglycemia (self-imposed stress factors)
<b>deceleration (negative acceleration)</b>	any reduction in the velocity of a moving body.
<b>decibel</b>	An arbitrary unit for measuring the relative intensity of a sound.
<b>decompression</b>	Any reduction in the pressure of one's surroundings. The chamber is decompressed each time it ascends.
<b>decompression sickness</b>	the effects produced by the evolvment of body gases or the expansion of trapped body gases when the ambient pressure is decreased, as in ascent to altitude.
<b>demo</b>	demonstration

<b>denitrogenation</b>	the reduction of nitrogen concentration in the body. Nitrogen concentration can be reduced by breathing 100 percent oxygen over a period of time. This diffuses the nitrogen from the blood to the lungs and eliminates much of the nitrogen dissolved in the body tissues.
<b>diffusion</b>	the process through which a substance moves from a place of high concentration to a new location of lower concentration. An example would be the diffusion of carbon dioxide from the tissue (with a partial pressure of 50 mm/Hg) to the blood (with a partial pressure of 40 mm/Hg).
<b>diluter-demand oxygen regulator</b>	a supplementary oxygen-delivery system in which a dilution of pure oxygen (with ambient air) is provided automatically to the individual with each inspiration. At 34,000 feet, the system will deliver 100 percent oxygen automatically with each inhalation.
<b>ejection</b>	a method of emergency escape from aircraft in which the pilot's or aircrew member's seat is propelled out of the aircraft by an explosive catapult or rocket charge.
<b>endolymph</b>	the watery fluid contained in the membranous labyrinth of the ear.
<b>EPT</b>	expected performance time
<b>erythrocytes</b>	the red blood cells.
<b>euphoria</b>	a feeling of well-being.
<b>eustachian tube</b>	the passage leading from the middle ear to the pharynx. It provides the only means by which equalization can be maintained between the pressure in the middle ear and the ambient pressure during flight.
<b>evaporation</b>	the process through which a liquid changes to a gaseous state and, in doing so, adds to its temperature. For example, when sweat evaporates (changes from a liquid to a vapor), it takes heat from the body and increases its own temperature.
<b>expiration</b>	the act of exhaling, or breathing outward. Normally, expiration involves the contraction of certain abdominal muscles and the relaxation of the diaphragm.
<b>explosive decompression</b>	a collision of two air masses that makes an explosive sound. A decompression that occurs in about one second or less is termed an "explosive decompression."
<b>external respiration</b>	the movement of air into and out of the lungs, the ventilation of the lung passages and the alveoli, and the diffusion of gas across the alveolar-capillary membrane.
<b>F</b>	Fahrenheit
<b>FAA</b>	Federal Aviation Administration
<b>Fe<sub>2</sub></b>	iron content within hemoglobin

---

<b>FFD</b>	full flying duty
<b>flatus</b>	the gas or air in the gastrointestinal tract.
<b>FM</b>	field manual
<b>FOV</b>	field of view
<b>fpm</b>	feet per minute
<b>fps<sup>2</sup></b>	feet per second per second
<b>frequency</b>	the measurable characteristic of noise that gives it distinctive pitch; it is measured in cycles per second or hertz.
<b>ft</b>	feet
<b>fwd</b>	forward
<b>G</b>	unit of acceleration
<b>G-force</b>	gravitational force
<b>G-force (+Gx)</b>	the positive accelerative force that acts to move the body at a right angle to the long axis in a back-to-chest direction.
<b>G-force (-Gx)</b>	the negative accelerative force that acts to move the body at a right angle to the long axis in a chest-to-back direction.
<b>G-force (+Gy, -Gy)</b>	the positive or negative accelerative force that acts to move the body at a right angle to the long axis in a shoulder-to-shoulder direction.
<b>G-force (+Gz)</b>	the positive accelerative force that acts to move the body in a headward direction.
<b>G-force (-Gz)</b>	the negative accelerative force that acts to move the body in a direction toward the feet.
<b>glare</b>	a bright light entering the eye, causing rapid loss of sensitivity.
<b>glottis</b>	the vocal apparatus of the larynx.
<b>GRAM</b>	geometric perspective, motion parallax, retinal image size, aerial perspective
<b>gravity</b>	the force of attraction between the earth and all bodies on the earth by which each body is held to the earth's surface. The normal force that acts on all bodies at all times is 1 G.
<b>H<sub>2</sub></b>	hydrogen
<b>H<sub>2</sub>O</b>	water
<b>HAP</b>	high-altitude parachutist
<b>Hb</b>	hemoglobin
<b>He</b>	helium
<b>headward direction</b>	the movement toward the head or in direction of the head.

<b>heat</b>	in the absolute sense, the motion of the molecules of any substance. The greater the motion, the higher the heat content. The heat content of any object is measured in calories.
<b>heat cramps</b>	a condition marked by sudden development of cramps in skeletal muscles. It results from prolonged work in high temperatures and is accompanied by profuse perspiration with loss of sodium chloride (salt) from the body.
<b>heat exhaustion</b>	a condition marked by weakness, nausea, dizziness, and profuse sweating. It results from physical exertion in a hot environment.
<b>heatstroke</b>	an abnormal physiological condition produced by exposure to intense heat and characterized by hot, dry skin (caused by cessation of sweating), vomiting, convulsions, and collapse. In severe cases, the body's heat control mechanism may be disturbed and the body temperature will rise to morbid levels.
<b>hemoglobin</b>	an organic, chemical compound contained within the red blood cells that combines with oxygen to form oxyhemoglobin. In this combination, oxygen is transported in the body.
<b>Henry's Law</b>	the physical law that states that the amount of gas that can be dissolved in a liquid is directly proportional to the pressure of that gas over the liquid.
<b>Hg</b>	mercury
<b>HOS</b>	helicopter oxygen system
<b>HQ</b>	headquarters
<b>hr</b>	hour
<b>hyperbaric dive</b>	the exposure to increased air pressure by insertion of compressed air into a metal chamber to simulate the pressure found in underwater diving. This exposure to increased pressure is also used as therapy for certain illnesses such as evolved-gas disorders or decompression sickness.
<b>hyperventilation</b>	an abnormally rapid rate of respiration that may lead to the excessive loss of carbon dioxide from the lungs and result in alkalosis. Hyperventilation is characterized by dizziness, tingling of the extremities, and in acute cases, collapse.
<b>hypoxia</b>	any condition in which oxygen concentration of the body is below normal limits or in which oxygen available to the body cannot be used because of some pathological condition.
<b>hypoxia (histotoxic)</b>	the hypoxia induced by the inability of the body's tissues to accept oxygen from the blood. An example of this type is cyanide or alcohol poisoning.
<b>hypoxia (hypemic)</b>	the hypoxia caused by the reduced capacity of the blood to carry oxygen. Two examples of hypemic hypoxia are anemia caused by an iron deficiency or reduction in the amount of red blood cells and carbon monoxide poisoning caused by carbon monoxide

---

	combining with hemoglobin and reducing the oxygen-carrying capacity of the hemoglobin.
<b>hypoxia (hypoxic)</b>	the hypoxia caused by a decrease in the partial pressure of respired oxygen or by the inability of the oxygen in the air to reach the alveolar-capillary membrane; for example, strangulation, asthma, and pneumonia. This type is also known as altitude hypoxia.
<b>hypoxia (stagnant)</b>	a condition that results from the failure of the blood to transport the oxygen rapidly enough; for example, shock or a heart attack in which the blood moves sluggishly.
<b>Hz</b>	hertz
<b>ICS</b>	internal communication system
<b>IERW</b>	initial entry rotary wing
<b>IFF</b>	identification, friend or foe (radar)
<b>IFR</b>	instrument flight rules
<b>illusion</b>	a false impression or a misconception with respect to actual conditions or reality.
<b>IMC</b>	instrument meteorological conditions
<b>inertial force</b>	the resistance to a change in the state of rest or motion. A body at rest tends to remain at rest, or a body in motion tends to remain in motion.
<b>in/Hg</b>	inches of mercury
<b>inspiration</b>	the act of drawing air into the lungs.
<b>intensity</b>	the loudness or pressure produced by a given noise. It is measure in decibels.
<b>internal respiration</b>	the transport of oxygen and carbon dioxide by the blood and the diffusion of these gases into and out of the body tissues. It also includes the use of the oxygen in metabolism and the elimination of carbon dioxide and water as waste products.
<b>iodopsin</b>	a photosensitive violet retinal pigment found in retinal cones and important for color vision.
<b>iris</b>	the opaque, contractile diaphragm perforated by the pupil and forming the colored portion of the eye.
<b>isobaric control</b>	the cabin altitude control achieved by maintaining a constant pressure as the ambient barometric pressure decreases.
<b>isobaric differential</b>	a system built into certain aircraft to control the pressurized environment at a predetermined level.
<b>jet stream</b>	a relatively narrow band of high-velocity winds located between 35,000 and 55,000 feet at the approximate latitudes of 300 to 550.

<b>jolt</b>	the rate of change of acceleration or rate of onset of accelerative forces.
<b>JP</b>	jet propulsion
<b>KITO</b>	known size of objects, increased and decreased size of objects, terrestrial association, and overlapping contours or interposition of objects
<b>Kr</b>	krypton
<b>LASIK</b>	laser in situ keratomileusis
<b>LAV</b>	linear perspective, apparent foreshortening, and vertical position
<b>lens</b>	the portion of the eye that focuses light rays on the retina. It is located behind the pupil.
<b>leukocytes</b>	the white blood cells.
<b>linear acceleration</b>	any change in the speed of an object without a change in its direction; for example, increasing the speed of an automobile from 40 to 65 miles per hour while driving down a straight-and-level highway.
<b>L-1 maneuver</b>	a physiological maneuver that increases G tolerance.
<b>m</b>	meter
<b>MAC</b>	maximum allowable concentration
<b>max</b>	maximum
<b>med</b>	medical
<b>MEDEVAC</b>	medical evacuation
<b>mesopic vision</b>	a combination of cone and rod vision used at dawn or twilight wherein both rod cells and cone cells are used but not to their maximum point of efficiency.
<b>metabolism</b>	the chemical changes in living cells by which energy is provided for vital processes and activities and new material is assimilated.
<b>mg</b>	milligram
<b>mil</b>	military
<b>min</b>	minutes
<b>miosis</b>	the contraction of the pupil of the eye.
<b>mm/Hg</b>	millimeters of mercury
<b>MOPP</b>	mission-oriented protective posture
<b>mph</b>	miles per hour
<b>MSL</b>	mean sea level
<b>mt</b>	mount
<b>N<sub>2</sub></b>	nitrogen

---

<b>NATO</b>	North Atlantic Treaty Organization
<b>NAVMED</b>	Naval Medical Command
<b>NAVSUP</b>	Naval Supply Systems Command
<b>NBC</b>	nuclear, biological, chemical
<b>ND</b>	neutral density
<b>Ne</b>	neon
<b>NH<sub>3</sub></b>	ammonia
<b>no</b>	number
<b>NSN</b>	national stock number
<b>NVG</b>	night-vision goggles
<b>O<sub>2</sub></b>	oxygen
<b>OBOGS</b>	onboard oxygen-generating system
<b>OH</b>	observation helicopter
<b>OLOGS</b>	open-loop oxygen-generating system
<b>otolith organs</b>	the small sacs located in the vestibule of the inner ear.
<b>oxidation</b>	the act of oxidizing or state of being oxidized; to combine with oxygen. Chemically, it consists of an increase of positive charges on an atom or a loss of negative charges.
<b>oxygen flow indicator</b>	an instrument connected directly to the oxygen regulator that indicates the flow of oxygen through the regulator during the user's respiratory cycle. This flow is manifested by the movement of shutters on the face of the indicator.
<b>oz</b>	ounce
<b>P</b>	pressure
<b>pallor</b>	a paleness or absence of skin coloration.
<b>PAO<sub>2</sub></b>	alveolar partial pressure of oxygen
<b>paresthesia</b>	a form of decompression sickness characterized by abnormal skin sensations; for example, itching and hot and cold sensations. It may be caused by the formation of gas bubbles in the layers beneath the skin.
<b>partial pressure</b>	the pressure exerted by any single constituent of a mixture of gases.
<b>PCO<sub>2</sub></b>	partial pressure of carbon dioxide
<b>peak G</b>	the degree of intensity of an acceleration.
<b>pH</b>	relative acidity of blood: chemical balance
<b>photopic</b>	the vision in the daytime or in bright light in which cones of the retina are primarily used.

<b>pitch</b>	the rotation of an aircraft about its lateral axis.
<b>plasma</b>	the fluid portion of the blood containing many dissolved compounds including proteins, carbon dioxide, bicarbonates, sugar, and sodium.
<b>platelets</b>	disk-shaped structures found in the blood and known chiefly for their role in blood coagulation.
<b>PO<sub>2</sub></b>	partial pressure of oxygen
<b>POI</b>	program of instruction
<b>ppm</b>	parts per million
<b>presbycusis</b>	a hearing loss attributed to old age and the aging process in general. It can be conductive or sensorineural in nature; it is commonly referred to as “senile deafness.”
<b>presbyopia</b>	a visual condition that becomes apparent especially in middle age and in which loss of elasticity of the lens of the eye causes defective accommodation and inability to focus sharply for near vision.
<b>pressure altitude</b>	a pressure expressed in feet of altitude. It can be obtained by reading the altitude indicated on the altimeter set at 29.92in/Hg (the standard datum plane).
<b>pressure breathing</b>	the act of breathing in which the gases respired are at a pressure greater than the ambient pressure. During pressure breathing, the normal respiratory cycle is reversed; that is, inhalation becomes the passive phase of respiration and exhalation, the active phase.
<b>pressure demand</b>	a type of oxygen-delivery system (mask and regulator) that incorporates both the standard demand mechanism and a mechanism for delivering oxygen under a positive pressure to the user. This process necessitates pressure breathing.
<b>pressure differential</b>	the difference in pressure, usually expressed in pounds per square inch, that exists between one or more objects or parts of the same object. This also refers to a system of pressurizing aircraft cabins in which the cabin pressure is kept uniformly higher than the ambient pressure.
<b>pressure gauge</b>	an instrument used to measure the air or oxygen pressure in any given system. The dial on the face of this gauge indicates the pressure within the system in pounds per square inch.
<b>pressure suit (full)</b>	a specially designed suit that protects the individual by surrounding the body with a pressurized gas envelope.
<b>pressurized cabin</b>	any aircraft interior that is maintained at a pressure greater than ambient pressure.
<b>PRK</b>	photorefractive keratectomy

---

<b>proprioceptive system</b>	a combination of the vestibular, subcutaneous, and kinesthetic sensors that enables an individual to determine body position and its movement in space.
<b>psi</b>	pounds per square inch
<b>pub</b>	publication
<b>PVO<sub>2</sub></b>	venous pressure of oxygen
<b>radial acceleration</b>	any change in the direction of a moving body without a change in its speed.
<b>radial keratotomy</b>	a surgical procedure that creates multiple, radial, spokelike incisions on the cornea of the eye in an effort to produce better visual acuity.
<b>radiation (heat)</b>	the transfer of heat in the form of wave energy from a relatively warmer body to a cooler body.
<b>rapid decompression</b>	the sudden loss of pressure from an area of relatively high pressure to one of a lower pressure. Conventionally, a decompression that occurs in one second or more is termed a "rapid decompression."
<b>RBC</b>	red blood cell
<b>red blood cells</b>	the cells in blood that contain, among several other components, the hemoglobin necessary for transport of oxygen.
<b>redout</b>	the phenomenon in which individuals lose their vision (and concurrently sometimes lose consciousness) and see nothing but red in their field of vision. It often occurs when individuals are experiencing -Gz. Redout is believed to be the result of engorgement of facial blood vessels and the movement of the lower eyelid over the eye.
<b>relative gas expansion</b>	the number of times that a given volume of gas will expand when the pressure surrounding it is reduced. It is conventionally determined for body gases by dividing the initial gas pressure by the estimate final gas pressure. These pressures must be corrected for the constant water vapor pressure of 47 mm/Hg at normal body temperature.
<b>relative humidity</b>	the amount of water vapor in a given sample of air at a given temperature. This is expressed as a percentage of the maximum amount of water vapor that the same sample could contain at that temperature.
<b>REM</b>	rapid eye movement
<b>residual volume</b>	the volume of air always present in the lungs and that can be removed only by surgery.
<b>respiration</b>	the process of pulmonary ventilation. This involves gas diffusion between the lungs and the blood, gas transport by the blood between the lungs and body tissues, the diffusion of gas between the blood and the body tissues, the use of oxygen within the cells,

and the elimination of carbon dioxide and water as the chief waste products of the cell.

<b>retina</b>	the sensory membrane that lines the eye, receives the image formed by the lens, is the immediate instrument of vision, and is connected with the brain by the optic nerve.
<b>retinal rivalry</b>	the difficulty that eyes have in simultaneously perceiving two dissimilar objects independent of each other because of the dominance of one eye.
<b>rhodopsin</b>	a photosensitive purple-red chromoprotein in the retinal rods that enhances night vision; commonly referred to as visual purple.
<b>rods</b>	the nerve endings located in the periphery of the retina that are sensitive to the lowest light intensities. They respond to faint light at night and in poor illumination. The rods can neither discern color nor perceive detail.
<b>roll</b>	the rotation of aircraft about the longitudinal axis.
<b>RPM</b>	revolutions per minute
<b>scuba</b>	self-contained underwater breathing apparatus
<b>SD</b>	spatial disorientation
<b>sec</b>	second
<b>SF</b>	standard form
<b>SL</b>	sea level
<b>SOP</b>	standing operating procedure
<b>speed</b>	The magnitude of motion and the rate of change of an object. It is expressed as distance covered in a unit of time such as miles per hour.
<b>SR</b>	special report
<b>ST</b>	special text
<b>STANAG</b>	standardization agreement
<b>STEL</b>	short-term exposure limit
<b>TB</b>	technical bulletin
<b>TC</b>	training circular
<b>TH</b>	training helicopter
<b>TLV</b>	threshold limit value
<b>TM</b>	technical manual
<b>TO</b>	technical order
<b>TRADOC</b>	United States Army Training and Doctrine Command
<b>UH</b>	utility helicopter
<b>US</b>	United States (of America)

---

<b>USA</b>	United States Army
<b>USAARL</b>	United States Army Aeromedical Research Laboratory
<b>USAAVNC</b>	United States Army Aviation Center
<b>USAF</b>	United States Air Force
<b>USAFSAM</b>	United States Air Force School of Aviation Medicine
<b>USAR</b>	United States Army Reserve
<b>USASAM</b>	United States Army School of Aviation Medicine
<b>velocity</b>	the speed in a given direction. It describes the magnitude and the direction of motion. Velocity is measured in distance per unit of time such as feet per second.
<b>vestibule (of ear)</b>	the oval cavity in the middle of the bony labyrinth in the ear.
<b>VMC</b>	visual meteorological conditions
<b>WBC</b>	white blood cell
<b>WGBT</b>	wet globe bulb temperature
<b>Xe</b>	xenon
<b>yaw</b>	the rotation of aircraft about the vertical axis

## Bibliography

- AF702. *Individual Physiological Training Record*. 1 December 1993.
- AF1274. *Physiological Training*. 1 August 1989.
- AFI11-403. *Aerospace Physiological Training Program*. 1 July 1999.
- AGARD 154. *Aeromedical Handbook for Aircrew*.
- AR 40-5. *Preventive Medicine*. 15 October 1990.
- AR 40-8. *Temporary Flying Restrictions Due to Exogenous Factors*. 17 August 1976.
- AR 40-501. *Standards of Medical Fitness*. 30 August 1995.
- AR 50-5. *Nuclear and Chemical Weapons and Material— Nuclear Surety*. 3 October 1986.
- AR 50-6. *Nuclear and Chemical Weapons and Materiel, Chemical Surety*. 1 February 1995.
- AR 95-1. *Flight Regulations*. 1 September 1997.
- AR 95-27. *Operational Procedures for Aircraft Carrying Hazardous Materials (AFJI 11-204)*. 11 November 1994.
- AR 310-25. *Dictionary of United States Army Terms (Short Title: AD)*. 15 October 1983.
- AR 310-50. *Authorized Abbreviations and Brevity Codes*. 15 November 1985.
- DA Form 759. *Individual Flight Record and Flight Certificate—Army*. April 1998.
- DA Form 2028. *Recommended Changes to Publications and Blank Forms*. 1 February 1974.
- DA Form 3444. *Terminal Digit File for Treatment Record*. May 1991.
- DA Form 4186. *Medical Recommendation for Flying Duty*. January 1985.
- Ellis, Albert, and Harper, Robert. *A New Guide to Rational Living*. Hollywood: Wilshire Book Company, 1975.
- FM 3-04.202(1-202). *Environmental Flight*. 23 February 1983.
- FM 3-04.203(1-203). *Fundamentals of Flight*. 3 October 1988.
- FM 3-04.230(1-230). *Meteorology for Army Aviators*. 30 September 1982.
- FM 3-04.400(1-400). *Aviator's Handbook*. 31 May 1983.
- FM 3-11.5(3-5). *NBC Decontamination (FMFM 11-10)*. 17 November 1993.
- FM 3-11.100(3-100). *Chemical Operations Principles and Fundamentals (MCWP 3-3.7.1)*. 8 May 1996.
- FM 4-02.50(8-50). *Prevention and Medical Management of Laser Injuries*. 8 August 1990.

- FM 4-25-10(21-10). *Field Hygiene and Sanitation*. 21 June 2000.
- FM 4-25-11(21-11). *First Aid for Soldiers*. 27 October 1988.
- FM 8-9 (no new number available). *NATO Handbook on the Medical Aspects of NBC Defensive Operations (AMEDP-6(B) Part I—Nuclear Part II—Biological Part III—Chemical (NAVMED P-5059; AFJMAN 44-151VIV2V3)*. 1 February 1996.
- MIL-0-27210E. *Oxygen, Aviator's Breathing, Liquid and Gas*. Note: This military specification is available from Commanding Officer, Naval Publications and Forms Center, ATTN: NPFC 105, 5801 Tabor Avenue, Philadelphia, PA 19120.
- NAVMED 6150/2. *Special Duty Medical Abstract*.
- NAVMED 6410/7. *Completion of Physiological Training*.
- Selye, Hans, M.D. *The Stress of Life*. New York: McGraw-Hill Publishing Company, 1956.
- . *Stress Without Distress*. Philadelphia: Lippincott Publishing Company, 1974.
- SF 600. *Health Record—Chronological Record of Medical Care*. June 1997.
- STANAG 3114 (Edition Six). *Aeromedical Training of Flight Personnel*. 22 October 1986.
- TB Med 507. *Occupational and Environmental Health Prevention, Treatment and Control of Heat Injury (NAVMED P-5052; AFP 160-1)*. 25 July 1980.
- TC 1-204. *Night Flight Techniques and Procedures*. 27 December 1988.
- TC 1-210. *Aircrew Training Program Commander's Guide to Individual and Crew Standardization*. 3 October 1995.
- TM 3-4240-280-10. *Operator's Manual for Mask, Chemical-Biological: Aircraft, ABC-M24 and Accessories and Mask, Chemical-Biological, Tank, M25A1 and Accessories*. 15 March 1988.
- TM 10-8400-202-13. *Maintenance Instructions for NOMEX Flight Gear Coveralls, Types CWU-27/P and CWU-28/P; Gloves, Type GS-FRP-2; Jacket, Flyer's, Summer, Type CWU-36/P and Winter, Type CWU-45/P; Hood, Winter, Flyer's (CWU-17/P Jacket); Trousers, Flyer's, Extreme Cold Weather, CWU-18/P (TO 14P3-1-112)*. 15 October 1972.
- TM 10-8415-206-12&P. *Operator's and Organizational Maintenance Manual Including Repair Parts and Special Tools List for Helmet, Flyer's, Protective, Model SPH-4 Regular (NSN 8415-00-144-4981) and Extra Large (8415-00-144-4985)*. 5 May 1986.
- TM 38-250. *Preparing Hazardous Materials for Military Air Shipments (AFJM 24-204; NAVSUP PUB 505; MCO P4030.19G; DLAI 4145.3)*. 1 March 1997.
- TM 55-1680-351-10. *Operator's Manual for SRU-21/P Army Vest, Survival (NSN 8465-00-177-4819).(Large) (8465-01-174-2355) (Small)*. 22 August 1987.

TRADOC Program of Instruction 2C-IERW (Common Core). *Officer/Warrant Officer Rotary-Wing Aviator Course*. This POI is available from Commander, US Army Aviation Center, ATTN: ATZQ-DAP-TS, Fort Rucker, AL 36362-5000.

USAFSAM-SR-5-3. *Night Vision Manual for the Flight Surgeon*. August 1985.

# Index

## A

acceleration, 4-1 – 4-36  
    backward transverse-G, 4-7  
    forward transverse-G, 4-7  
    high-magnitude, 4-35, 4-36  
    low-magnitude, 4-14, 4-34  
    negative-G, 4-7, 4-26 – 4-30  
    positive-G, 4-7, 4-15 – 4-24  
    right or left lateral G, 4-7, 4-34  
    types of, 4-2 – 4-5  
        angular, 4-2, 4-5  
        linear, 4-2, 4-3  
        radial (centripetal), 4-1, 4-2, 4-4, 4-6, 4-7  
accelerative forces, 4-2 – 4-5, 4-8 – 4-13, 4-34, 4-37  
accident sequence, 4-38 – 4-41, 4-42 – 4-44  
acid-base balance, 2-44, 2-102  
acute  
    fatigue, 3-69  
    toxicity, 5-2, 5-3  
aeromedical training  
    in specific courses, 1-2  
    programs, 1-2, 1-15, 1-16  
    record, initial aeromedical training, 1-19  
    refresher training, 1-20  
    requirements  
        initial, 1-1  
        refresher, 1-3, 1-4  
        revalidation, 1-16  
    special (by other services), 1-5  
    unit, 1-6 – 1-12,  
    waivers, 1-17

aircraft  
    atmosphere  
        contamination, 5-15  
        design features, 4-38, 4-41  
aircrew restrictions  
    after scuba diving, 2-155  
alcohol, detrimental effects of, 2-67, 2-72, 2-74, 2-89, 2-99, 3-17, 3-27 – 3-35, 8-75  
altitude  
    chamber training  
        rapid decompression, A-4, A-5  
        Type II chamber flight, A-0, A-1  
        Type IV chamber flight, A-1 – A-3  
        Type V chamber flight, A-3, A-4  
alveolar pressure of oxygen, 2-62, 2-94  
alveoli, 2-57 – 2-61  
ampulla, 9-17  
angular acceleration, 4-5  
aqueous film-forming foam, 5-41  
Armstrong's line, 2-27  
astigmatism, 8-6  
atmosphere, 2-13 – 2-17  
    composition of, 2-13 – 2-17  
    gases of, 2-13 – 2-17  
    layers of, 2-2 – 2-11  
    ionosphere, 2-11  
    mesosphere, 2-8, 2-9  
    stratosphere, 2-5 – 2-7  
    thermosphere, 2-10, 2-11  
    tropopause, 2-5  
    troposphere, 2-3, 2-4  
    physical characteristics of, 2-1

physiological zones of, 2-23 – 2-26  
    deficient zone, 2-25  
    efficient zone, 2-24  
    space equivalent zone, 2-26  
atmospheric  
    gases, 2-13 – 2-17  
    pressure, 2-18, 2-19, 2-23, 2-26, 2-65, 2-120, 2-121, 2-125, 2-137  
axes  
    Gx, 4-7, 4-13, 4-31, 4-32, 4-39  
    Gy, 4-7, 4-34, 4-39  
    Gz, 4-7, 4-13, 4-15 – 4-23, 4-24, 4-26 – 4-30, 4-39

## B

barometric pressure, 2-18, 2-21, 2-25 – 2-27, 2-114, 2-115, 2-119, 2-125, 2-126, 2-136, 2-139  
bends, 2-147, 3-10  
blackout, 4-10, 4-19, 4-20  
blood  
    components and functions of, 2-32  
    pH level of, 2-49, 2-50  
    pooling in +Gz  
        acceleration, 4-30  
    transport of O<sub>2</sub> in, 2-33, 2-45  
blue-green lighting, 8-3, 8-39  
body  
    chemical balance, 2-47 – 2-49  
    heat balance, 2-46  
Boyle's law, 2-117  
breathing oxygen, 10-2, 10-5, 10-6, 10-7  
burnout, 3-68, 3-71

**C**

cabin pressurization, 2-82, 2-151, 2-153, 10-19, 10-20 – 10-28

caffeine, detrimental effects of, 3-23, 3-24, 3-93

carbon dioxide, 2-46, 2-53, 2-61, 2-62, 5-38 – 5-40  
 effect on pH level of blood, 2-49  
 partial pressure of, 2-49, 2-61  
 removal of, 2-46

carbon monoxide, 2-66, 2-73, 2-99, 5-8, 5-14, 5-15, 5-16, 5-17, 5-20, 5-21, 5-23, 5-25, 5-33, 8-76  
 danger associated with, 5-20, 5-21, 5-23  
 effects of, 5-17 – 5-19, 5-21  
 physiological response of body to, 5-17, 5-23 – 5-25  
 symptoms of intoxication, 5-14, 5-21, 5-25, 5-33  
 treatment of asphyxia, 5-25

central  
 blind spot. *See* night blind spot.  
 nervous system disorders, 2-150

centrifugal force, 4-1, 4-6, 4-14

centripetal force, 4-1, 4-6, 4-15

chamber flight training, 1-3, 1-4, 1-5  
 initial aeromedical, 1-19  
 revalidation, 1-16  
 training record, 1-18 – 1-21  
 waivers, 1-17

chokes, 2-148

chronic  
 fatigue, 3-70  
 toxicity, 5-4

circadian cycle, 3-77, 3-79, 3-82, 3-90

circulatory system, 2-27 – 2-38  
 function and structure of, 2-27 – 2-30

cold injury, 6-26 – 6-33  
 prevention of, 6-32, 6-33  
 treatment of, 6-31  
 types of, 6-28 – 6-31

conductive hearing loss, 7-23, 7-26

cone cells, 8-16, 8-17, 8-19, 8-24, 8-33

contamination  
 aircraft atmosphere, 5-15 – 5-44  
 aviation gasoline, 5-15, 5-26, 5-27, 5-28  
 carbon monoxide, 5-14 – 5-25  
 coolant fluid vapors, 5-15, 5-31, 5-32  
 engine lubricants, 5-15, 5-33  
 exhaust gases, 5-15, 5-16, 5-20  
 fire-extinguishing agents, 5-34 – 5-41  
 fluorocarbon plastics, 5-42  
 hydraulic fluid vapors, 5-30  
 JP fuels, 5-29  
 NBC environment, 5-15  
 oxygen contaminants, 5-15, 5-43  
 tetraethyl lead, 5-15, 5-28

continuous-flow oxygen, 10-10  
 regulator, 10-13, 10-14

Coriolis illusion, 9-39, 9-43 – 9-46

crash  
 forces, 4-38, 4-39  
 position, 4-44  
 sequence, 4-38 – 4-40

crashworthy design, 4-40, 4-41

CREEP factors, 4-41

cupula, 9-17, 9-19, 9-44, 9-46

**D**

Dalton's law of partial pressures, 2-18 – 2-22

damage-risk criteria, 7-16, 7-18

damping, 7-14

dark adaptation, 8-30 – 8-34.  
*See also* night vision protection.

day blind spot, 8-21

DEATH (acronym), 3-17, 8-72

decelerative forces, 4-11, 4-37, 4-39, 4-40, 4-42 *See also* negative acceleration.

decompression sickness, 2-23, 2-137, 2-140, 2-151, 2-157

decremental factors, 4-24

deficient zone, 2-26

denitrogenation, 2-152

depth perception, 8-41, 8-48 – 8-64  
 binocular cues, 8-48, 8-49  
 monocular cues, 8-48 – 8-50, 8-94

detoxification, 5-14

diet, 3-38, 3-40, 3-41, 3-92, 8-74, 8-77

diet pills, 3-41

diffusion of CO<sub>2</sub> and O<sub>2</sub>, 2-57 – 2-61

diluter-demand oxygen regulator, 10-9 – 10-12

dimming of vision, 4-19

distance estimation, 8-48 – 8-64  
 binocular cues, 8-49  
 monocular cues, 8-48 – 8-64

drugs, 3-18 – 3-22, 8-72, 8-73  
 effects of  
 alcohol use, 3-27 – 3-35, 8-72  
 tobacco use, 3-36, 3-37, 8-72, 8-76  
 effects on vision, 8-72, 8-73  
 problems of caffeine, 3-23, 3-24, 3-93

self-medication, 8-73  
 side effects of, 2-66, 3-18,  
 3-19  
 duration, 4-8, 4-10, 4-37, 4-39,  
 4-41, 7-5, 7-12, 7-15, 7-16  
 dysbarism, 2-114, 2-115

**E**

ear, 3-10, 3-36, 7-7, 7-11, 7-23,  
 7-25, 7-26, 7-33  
 E-A-R® foam earplug, 7-34, 7-  
 35, 7-39  
 earmuffs, 7-40  
 earplugs, 7-32, 7-34 – 7-39  
 efficient zone, 2-25  
 ejection seat, 4-10, 4-16  
 elevator illusion, 9-49  
 endolymph, 9-17, 9-44  
 EPT. *See* expected  
 performance time.  
 equilibrium, 9-2, 9-7 – 9-21, 9-  
 41  
 evolved-gas disorders, 2-14, 2-  
 115, 2-137 – 2-150. *See*  
*also* decompression  
 sickness.  
   cause of, 2-137, 2-140, 2-  
   141  
   prevention of, 2-151  
   treatment of, 2-156  
   types of, 2-146 – 2-150  
     bends, 2-147  
     central nervous system  
     disorders, 2-150  
     chokes, 2-148  
     paresthesia, 2-149  
 exhalation, 2-47, 2-51, 2-53, 2-  
 61, 2-97, 2-104, 2-106  
 exhaustion, 3-17, 3-25, 3-68, 3-  
 71, 8-72  
 expected performance time, 2-  
 82  
 explosive decompression, 10-  
 32  
 external respiration, 2-40, 2-42,  
 2-50 – 2-52  
 eye

anatomy and physiology  
 of, 8-13 – 8-21  
 physiology of, 8-13 – 8-21

**F**

fainting, 2-110  
 fatigue, 2-86, 2-122, 2-148, 3-  
 5, 3-8, 3-9, 3-15, 3-24, 3-38,  
 3-63, 3-67 – 3-71, 3-72 – 3-  
 79, 3-82, 3-84, 3-87, 3-88, 3-  
 92, 3-94, 3-95, 3-98, 3-102,  
 6-27. *See also* exhaustion.  
   treatment of, 3-98 – 3-101  
   types of, 3-68 – 3-71  
 “fight or flight” syndrome, 3-54  
 fire-extinguishing agents, 5-15,  
 5-34 – 5-41  
   aqueous film-forming  
   foam, 5-41  
   chemical classes of, 5-34  
   – 5-41  
   carbon dioxide, 5-38 – 5-  
   40  
   foam, 5-41  
   halogenated  
   hydrocarbons, 5-35 – 5-  
   37  
 flicker vertigo, 9-37  
 flying restrictions, 3-18  
 frequency, 7-2, 7-5, 7-6, 7-9, 7-  
 19, 7-21, 7-35, 7-40  
 frostbite, 6-26, 6-28, 6-31, 6-33

**G**

gaseous diffusion, 2-59  
 gaseous oxygen, 10-2, 10-3  
 gases of the atmosphere, 2-1,  
 2-13 – 2-17, 2-19, 2-118  
 gas expansion, 2-119. *See*  
*also* trapped gas disorders  
 and Boyle’s law.  
   under dry-gas conditions,  
   2-118  
   under wet-gas conditions,  
   2-119  
 G-forces, 4-7, 4-10, 4-14, 4-23  
 tolerance limits to, 4-23, 4-  
 39, 4-40

types of, 4-7  
 graveyard spin, 9-39, 9-41, 9-  
 42  
 gravitational forces, 4-6, 4-7  
 graying of visual field, 4-6, 4-20  
 greenhouse effect, 6-1  
 +Gx acceleration, 4-7  
   physiological effects of, 4-  
   31 – 4-33  
   tolerance to, 4-32  
 –Gx acceleration, 4-7  
   physiological effects of, 4-  
   31 – 4-33  
   tolerance to, 4-32  
 +/-Gy acceleration, 4-7  
   physiological effects of, 4-  
   34  
   tolerance to, 4-34  
 +Gz acceleration, 4-7  
   physiological effects of, 4-  
   15 – 4-23  
   tolerance to, 4-23  
     decremental factors, 4-  
     23, 4-24  
     incremental factors, 4-  
     23, 4-25  
 –Gz acceleration, 4-7  
   physiological effects of, 4-  
   26 – 4-30  
   tolerance to, 4-28

**H**

hair cells, 7-24, 7-25, 9-13, 9-  
 14, 9-17 – 9-21  
 hearing  
   damage, 7-4, 7-16, 7-18,  
   7-25, 7-28  
   loss, 7-16, 7-22  
     conductive, 7-23  
     noise-induced, 7-16, 7-  
     19, 7-29  
     permanent, 7-4, 7-19  
     presbycusis, 7-24  
     sensorineural, 7-25  
 protection, 7-27 – 7-40  
   devices for, 7-30 – 7-40

earmuffs, 7-40  
 earplugs, 7-35 – 7-39  
 helmets, 7-31 – 7-33

heat  
 injury, 6-15, 6-16  
 forms of  
     heat cramps, 6-16  
     heat exhaustion, 6-16  
     heatstroke, 6-16  
 stress  
     prevention of, 6-18  
     reduction of, 6-23  
     response to, 6-16

heatstroke, 6-16

heat transfer, 6-6 – 6-14  
 mechanisms of, 6-6 – 6-14  
     conduction, 6-8  
     convection, 6-9  
     evaporation, 6-10  
     radiation, 6-7

hemoglobin, 2-34, 2-48, 2-66, 2-73, 2-91, 8-76

Henry's law, 2-138, 2-139

high-magnitude  
 acceleration, 4-35 – 4-44  
     physiological effects of, 4-35, 4-36  
     protection against, 4-38 – 4-44  
 deceleration, 4-37  
     physiological effects of, 4-35  
     survival criteria, 4-38 – 4-41  
     tolerance to, 4-35, 4-37, 4-38 – 4-44

histotoxic hypoxia, 2-64, 2-67, 2-74, 2-93, 2-99

H-2 bailout bottle, 10-7

human sensory systems  
     proprioceptive system, 9-7, 9-22  
     vestibular system, 9-11 – 9-15, 9-22, 9-38, 9-51  
     visual system, 9-7, 9-8, 9-10, 9-22, 9-23, 9-51

humidity, 5-19

hypemic hypoxia, 2-66

hyperopia, 8-5

hyperventilation, 2-101 – 2-113

hypoglycemia, 3-17, 3-38 – 3-41, 8-77

hypothermia, 6-28

hypoxia, 2-33, 2-62 – 2-100, 3-10, 3-37, 9-52  
 characteristics of, 2-62  
 effects of, 2-81, 2-82  
 major classifications of, 2-63  
     histotoxic, 2-63, 2-67, 2-74, 2-93, 2-99  
     hypemic, 2-65, 5-22  
     hypoxic, 2-64  
         stagnant, 2-63, 2-66, 2-93, 2-99, 4-21  
 prevention of, 2-93, 2-99  
 signs and symptoms of, 2-68, 2-69  
 stages of, 2-83 – 2-92  
     compensatory, 2-85  
     critical, 2-92  
     disturbance, 2-86 – 2-91  
     indifferent, 2-84  
 susceptibility to, 2-70 – 2-80  
 treatment of, 2-100  
 types of, 2-63, 2-93

hypoxic hypoxia, 2-63, 2-64, 2-83 – 2-99

**I**

illusions, 8-48 – 8-65  
     proprioceptive, 9-51  
     vestibular, 9-38 – 9-50  
         somatogravic illusions  
         9-47 – 9-50  
             elevator, 9-47, 9-49  
             oculoagravic, 9-47, 9-50  
             oculogravic, 9-47, 9-48  
         somatogyral, 9-39 – 9-46

Coriolis illusion, 9-39, 9-43 – 9-46  
 graveyard spin, 9-39, 9-41, 9-42  
 leans, 9-40

visual, 8-65, 9-23 – 9-37

immersion foot. See trench foot

impulse noise, 7-15, 7-17, 7-18

incremental factors, 4-23, 4-25

inertial force, 4-1, 4-7, 4-27

inhalation, 2-104, 2-105, 2-148

initial aeromedical training, 1-1, 1-19

intensity, 4-8, 4-9, 4-37, 4-39, 7-5, 7-10, 7-11, 7-16, 7-17, 7-20

internal respiration, 2-40, 2-42

iodopsin, 8-19

ionosphere, 2-11

**J**

jet stream, 2-6  
 jolt, 4-37

**L**

lasers, 8-86 – 8-94

law of gaseous diffusion, 2-59

leans, 9-39, 9-40

linear acceleration, 4-3, 4-35

L-1 maneuver, 4-25

low blood-sugar level, 3-39, 8-77

low-magnitude acceleration, 4-14, 4-34

**M**

masks, oxygen, 10-14 – 10-17  
     MBU-12/P, 10-14, 10-16, 10-17  
     passenger, 10-14, 10-15

maximum allowable concentration, 5-13

maximum permissible sound level, 7-16

MBU-12/P oxygen mask, 10-14, 10-16, 10-17

mesopic vision, 8-22, 8-24

metabolism, 2-16

meteorological conditions and night vision, 8-66 – 8-71  
 miosis, 8-78 – 8-81  
 monocular cues, 8-48 – 8-64, 8-94  
     aerial perspective, 8-50, 8-61 – 8-64  
     geometric perspective, 8-50, 8-51 – 8-54  
     motion parallax, 8-50, 8-55, 8-57  
     retinal image size, 8-56 – 8-60  
 motivational burnout, 3-68, 3-71  
 myopia, 8-2  
     night 8-3

## N

natural body resonance, 7-13  
 nearsightedness. *See* myopia.  
 negative acceleration, 4-27, 4-35  
 nerve agents, 8-78 – 8-81  
 nicotine. *See* tobacco.  
 night blind spot, 8-26  
 night vision, 8-16, 8-18, 8-20, 8-31, 8-33 – 8-39, 8-66, 8-76 – 8-78, 8-81, 8-95  
     protection, 8-35 – 8-41  
     techniques, 8-42 – 8-47  
         off-center vision, 8-43 – 8-45  
         scanning, 8-46  
         shape or silhouette identification, 8-47  
 nitrogen, 2-13, 2-14, 2-17, 2-23, 2-121, 2-138 – 2-141, 2-150 – 2-156  
 noise, 7-1 – 7-19  
     characteristics and effects of, 7-1 – 7-4  
     levels, 7-15 – 7-19  
     in Army aircraft, 7-18, 7-30, 7-32, 7-34, 7-39  
 noise-induced hearing loss, 7-19

## O

obesity, 3-41  
 OBOGS. *See* onboard oxygen-generating systems.  
 occupiable living space, 4-38, 4-40  
 oculo-gravic illusion, 9-47, 9-50  
 oculogravic illusion, 9-47, 9-48  
 off-center viewing, 8-24, 8-27, 8-43, 8-45, 8-95  
 onboard oxygen-generating system, 10-4  
 orientation, 9-2, 9-8 – 9-10, 9-31  
 otolith organs, 9-11, 9-12 – 9-15, 9-47, 9-48  
 oxygen, 2-13, 2-15 – 2-18, 2-22, 2-25, 2-26, 2-29, 2-32 – 2-34, 2-41 – 2-44, 2-47, 2-58, 2-59, 2-61, 2-62, 2-64 – 2-67, 2-71, 2-73, 2-78, 2-79, 2-81, 2-82, 2-86, 2-91, 2-94 – 2-98, 2-100, 2-105, 2-107, 10-1 – 10-18  
     breathing, 10-2, 10-5, 10-6, 10-7  
     equipment, 10-18, 10-20, 10-27  
     equipment checklist, 10-18  
     gaseous, 10-2 – 10-4  
     intake of, 2-45  
     masks, 10-14 – 10-17  
     positive pressure of, 2-96  
     regulators, 10-9 – 10-13  
         continuous-flow, 10-10, 10-13, 10-14  
         diluter-demand, 10-10, 10-14  
         pressure-demand, 10-14  
     release of, 2-49  
     requirements for crew members, 2-77  
     saturation in the blood, 2-95, 2-96  
     storage systems, 10-5 – 10-8

gaseous high-pressure, 10-6 – 10-8  
 gaseous low-pressure, 10-5  
 onboard oxygen-generating, 10-4  
 supplemental, 2-26, 2-93, 2-94, 2-97, 8-38, 8-75, 8-95  
 uptake of, 2-47, 2-49, 2-106, 2-154, 2-155

## P

PAO<sub>2</sub> level, 2-94  
 paresthesia, 2-149, 2-150  
 partial pressure  
     formula, 2-19  
     of carbon dioxide, 2-49, 2-61  
     of gases in atmosphere, 2-18 – 2-22  
     of oxygen. *See* PO<sub>2</sub> level.  
 passenger oxygen mask, 10-14, 10-15  
 PCO<sub>2</sub> level, 2-49, 2-61  
 peak G, 4-37, 4-41  
 perception time, 8-29  
 peripheral vision, 8-27  
 pH level, 2-49, 2-50  
 photopic vision, 8-22, 8-23  
 photosynthesis, 2-16  
 physiological altitude, 2-72 – 2-74, 8-75  
 physiological zones of the atmosphere, 2-23 – 2-26  
 plasma, 2-39  
 platelets, 2-38  
 positive pressure, 2-97, 2-105, 2-135, 10-14  
 PO<sub>2</sub> level, 2-22, 2-25, 2-33, 2-60, 2-64  
 presbycusis, 7-22, 7-24  
 presbyopia, 8-7  
 pressure breathing, 2-102, 2-104 – 2-106  
 pressurization, 2-26, 2-82, 2-98, 2-130, 2-146, 2-151, 2-

153, 10-10, 10-19, 10-20, 10-22, 10-26 – 10-28, 10-35

proprioceptive  
 illusions, 9-51  
 system, 9-1, 9-22

protective devices (for hearing), 7-30 – 7-40

PVO<sub>2</sub> level, 2-62

**Q**

quick-don mask assembly unit, 10-10, 10-14

**R**

radial  
 acceleration, 4-2, 4-4  
 keratotomy, 8-9

rapid decompression, 2-82, 10-28, 10-30, 10-31 – 10-35, 10-36

reactions and responses to stress, 3-1, 3-46 – 3-56

red blood cells, 2-33 – 2-36

red-lens goggles, 8-37

red lighting, 8-37, 8-39

redout, 4-29

refresher aeromedical training, 1-3, 1-4

relative fatigue factor, 3-95

respiration, 2-14 – 2-16, 2-39 – 2-61, 2-85, 2-101, 2-103, 2-111, 2-112  
 external, 2-40, 2-42, 2-50 – 2-52  
 functions of, 2-43 – 2-49  
 internal, 2-43  
 phases of  
 active, 2-50, 2-51  
 passive, 2-50, 2-52

respiratory system, 2-39 – 2-61  
 components of, 2-53 – 2-61  
 alveoli, 2-58, 2-59  
 oral-nasal passage, 2-55  
 pharynx, 2-56  
 trachea, 2-57

retinal rivalry, 8-8

rhodopsin, 8-19, 8-20, 8-30, 8-36, 8-37, 8-77

rod cells, 8-15, 8-16, 8-18 – 8-20

**S**

scanning, 8-24, 8-46, 8-74, 8-75, 8-94

scotopic vision, 8-22 – 8-25

“seat-of-the-pants” flying, 9-22

self-imposed stress, 2-72 – 2-74, 8-72 – 8-77. *See also* stress.

self-medication, 8-73

self-talk, 3-64

semicircular canals, 9-11, 9-16, 9-17, 9-39, 9-41, 9-42

sensorineural hearing loss, 7-25

sensory illusion, 9-2

short-term exposure limits, 5-12

smoking. *See* tobacco, detrimental effects of.

SMR triple-flange earplug, 7-35, 7-38

solar radiant heat, 6-3

somatogravic illusions, 9-47 – 9-50

somatogyral illusions, 9-39 – 9-46

sound  
 characteristics of, 7-5  
 duration, 7-5, 7-12  
 frequency, 7-5, 7-6  
 intensity, 7-5, 7-10, 7-11  
 levels, 7-15 – 7-19  
 types of, 7-15 – 7-19  
 impulse noise, 7-17 – 7-19  
 steady-state noise, 7-16  
 measurement, 7-5 – 7-12  
 pressure, 7-10, 7-11

space equivalent zone, 2-27

spatial disorientation, 8-65  
 defined, 9-1

types of, 9-4 – 9-6

special aeromedical training by other services, 1-5, 1-21

speech communication, 7-3, 7-8, 7-30

SPH-4 flight helmet, 7-31, 7-34

stagnant hypoxia, 2-63, 2-66, 2-93, 2-99, 4-21

STANAG 3114, 1-2

steady-state noise, 7-15, 7-16

STEL. *See* short-term exposure limit

stratosphere, 2-5 – 2-7

stress  
 aviation-related, 3-17  
 concepts of, 3-1  
 control, 3-17, 3-44  
 factors of, 3-14  
 heat, 6-15 – 6-18, 6-20, 6-23, 6-24, 6-26  
 management of, 3-62 – 3-66  
 principles of, 2-10  
 responses to, 3-46 – 3-56  
 self-imposed, 3-17 – 3-41, 8-72 – 8-77  
 sources of, 3-5, 3-8, 3-42

stressors, self-imposed, 3-17 – 3-41, 8-72 – 8-77

structural illusions, 9-29

supplemental oxygen, 2-94, 2-95, 2-98

survivability, 4-35, 4-40

survival criteria, 4-38 – 4-41

**T**

temperature, 3-12, 3-77, 3-78, 3-81, 3-96, 3-97. *See also* windchill factor.  
 conversion, 6-33  
 extremes of cold, 3-12, 6-26  
 heat, 3-12, 6-1  
 lapse rate, 2-4  
 resulting from windchill factor, 6-33

threshold limit values, 5-12

time and dose relationship, 5-5  
 TLV. See threshold limit values.  
 tobacco, detrimental effects of, 2-72, 2-73, 8-72, 8-76  
 toxic  
   agents, 5-4, 5-7, 5-8, 5-44  
   hazards, 5-44  
   protective measures, 5-44  
 toxicity  
   acute, 5-2, 5-3  
   chronic, 5-4  
 toxicology in aviation, 5-1 – 5-14  
 training, aeromedical, 1-2, 1-10 – 1-12, 1-19, 1-21, 1-22  
 trapped-gas disorders, 2-115, 2-116 – 2-136, 3-10  
 trench foot, 6-28, 6-33  
 tropopause, 2-5  
 troposphere, 2-3, 2-4

## U

unconsciousness, 4-10, 4-18 – 4-20  
 unit aeromedical training program, 1-6 – 1-15

## V

Valsalva maneuver, 2-127, 2-130, 2-134, 2-135  
 venous pressure of oxygen, 2-62  
 vertigo, 9-3  
 vestibular illusions, 9-38 – 9-50  
 vestibular system, 9-11 – 9-21  
 V-51R single-flange earplug, 7-35, 7-37, 7-38  
 vibration, 7-1, 7-9, 7-20, 7-21  
 visibility, 8-28, 8-62, 8-66  
 vision  
   effect of self-imposed stress on, 8-72 – 8-77  
   night, 8-16, 8-18, 8-20, 8-31, 8-33 – 8-47, 8-66, 8-76, 8-77, 8-78 – 8-81, 8-95  
   principles of, 8-95

types of, 8-22 – 8-27  
   mesopic, 8-22, 8-24  
   photopic, 8-22, 8-23  
   scotopic, 8-22, 8-25 – 8-27

## visual

deficiencies, 8-1 – 8-12  
 astigmatism, 8-6  
 cataract formation, 8-7  
 hyperopia, 8-5  
 LASIK, 8-11, 8-12  
 myopia, 8-2, 8-3  
 night myopia, 8-3  
 photorefractive  
   keratectotomy, 8-10  
 presbyopia, 8-7  
 radial keratotomy, 8-9  
 retinal rivalry, 8-8  
 surgical procedures, 8-9 – 8-11  
 fixation reflex, 8-23  
 illusions, 8-65, 9-23 – 9-37  
 purple, 8-19, 8-30, 8-77  
 system, 9-8 – 9-10

vitamin A, 8-77

## W

white blood cells, 2-37  
 windchill factor, 6-32, 6-33

**FM 3-04.301(FM 1-301)**  
**29 SEPTEMBER 2000**

By Order of the Secretary of the Army:

Official:



JOEL B. HUDSON  
*Administrative Assistant to the  
Secretary of the Army*

0023101

ERIC K. SHINSEKI  
*General, United States Army  
Chief of Staff*

**DISTRIBUTION:**

*Active Army, Army National Guard, and U. S. Army Reserve:* To be distributed in accordance with the initial distribution number 110725, requirements for FM 3-04.301.